

Material Specification - Thickness 2.5mm

Available Finish - Hot Dip Galvanised
- Stainless Steel

Note - Stainless Steel products are manufactured against firm orders only. They are non returnable and the order cannot be cancelled once manufacturing has commenced.
- Load Capacities are based on the application of a uniformly distributed load.
- Powder coating and special finishes on request against firm orders only and are non returnable.

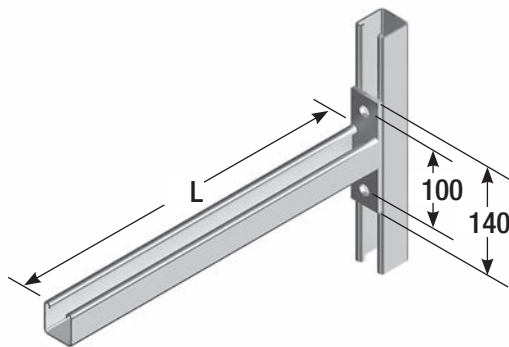

Cantilever Bracket CL

Ordering Code	Length L	Load Capacity kg
CL150	150	566
CL300	300	283
CL450	450	189
CL600	600	141
CL750	750	113
CL900H	900	94

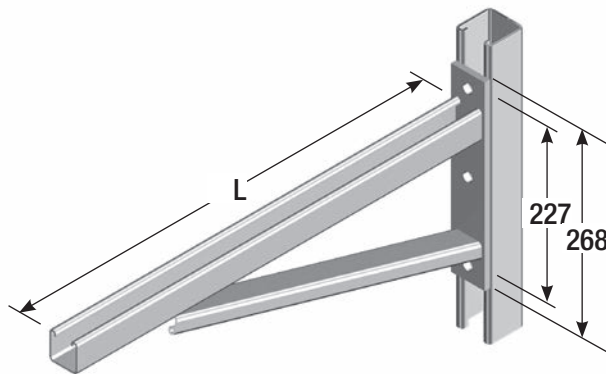

Cantilever Bracket CLB

Ordering Code	Length L	Load Capacity kg
CLB320	320	435
CLB470	470	364
CLB635	635	316
CLB780	780	288

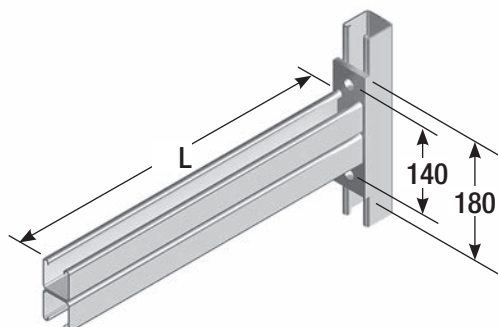

Cantilever Bracket CLD

Ordering Code	Length L	Load Capacity kg
CLD300	300	424
CLD450	450	283
CLD600	600	212
CLD750	750	170

CHANNELS 1

NUTS & BOLTS 2

CANTILEVER BRACKETS 3

CHANNEL FITTINGS 4

LADDERTRAYS 5

CABLE MESH 6

STEEL LADDERS 7

ALUMINIUM LADDERS 8

FIRE RATED 9

COVERS 10

HYGROUND 11