

Wall mounting socket outlet - housing dimensions 170x118



Product description	
BALS-Prd.-Nr	1157
EAN	4024941011570
Product category	Wall mounting socket outlet
Current	63A
Number of poles	3p
Arrangement of phases	2P+PE
Position of earth contact	6 h
Voltage	200 - 250V~

Product description	
Frequency	50/60Hz
Protection degree	IP67
Colour code	blue RAL 5015
Colour of appliance	Hinged lid blue RAL 5015, Bayonet ring grey RAL 7035, Housing bottom grey RAL 7035, Housing top grey RAL 7035
Connection design	screw terminal as box terminal with Kontex-contact
Maximum conductor size	25.0 qmm
Cable entry	top entry M40 bottom entry M32
Height	228mm
Width	118mm
Depth	176mm
Dimension of enclosure	170x118 mm (HxW)
Material of enclosure	Polycarbonate
Contacts	The contact carrier is made of high temperature resistant material, the contacts are brass nickel plated

Additional technical information	
	The cable entry is one at top open and two at bottom closed
	Lower part of housing rotatable by 180°

Logistics data	
Weight/pcs	0.8 kg / Piece

Logistics data	
Packaging	Bag
Content amount	1 ST
EAN	4024941011570
Length	176 mm
Width	118 mm
Height	228 mm
Weight	0.801 kg
Volume	4,735.104 ccm
Packaging	Carton
Content amount	5 ST
EAN	4024941958493
Length	345 mm
Width	345 mm
Height	217 mm
Weight	4.335 kg
Volume	24,276 ccm

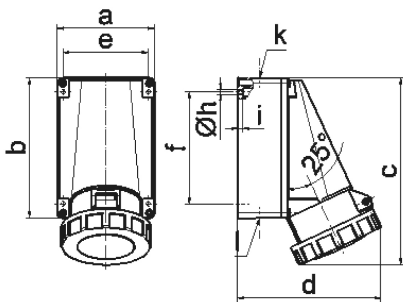

1 MB 3

Ampere	63	63	63			
Polzahl	3	4	5			
a	118,0	118,0	118,0			
b	170,0	170,0	170,0			
c	228,0	228,0	228,0			
d	176,0	176,0	176,0			
e	104,0	104,0	104,0			
f	136,0	136,0	136,0			
h ø	6,1	6,1	6,1			
i	6,0	6,0	6,0			
k	M40	M40	M40			
l	M32/32	M32/32	M32/32			
Leiter mm ² min	6	6	6			
Leiter mm ² max	25	25	25			