



Three-phase busbar link, Protected against accidental contact, short-circuit proof, $U_e = 690\text{ V}$, $I_u = 63\text{ A}$, Circuit-breaker: 3, Unit width 45 + 9 mm, Type of electric connection: Fork

Part no. B3.1/3-PKZ0
Catalog No. 044946
Alternate Catalog No. XTPAXCLKB3
EL-Nummer (Norway) 4357201

Delivery program

Product range		Accessories
Accessories		Three-phase busbar link
		For parallel power feed to several motor-protective circuit-breakers on terminals 1, 3, 5 Protected against accidental contact, short-circuit proof, $U_e = 690\text{ V}$, $I_u = 63\text{ A}$ Can be extended by rotating by installation For PKZM0-... or PKE attached on the right with an auxiliary contact or trip indicating signal When mounted on the same DIN rail, PKE12/32 and PKZM0 cannot both be connected to a three-phase commoning link.
For use with		PKZ0, PKE12, PKE32
Circuit-breaker	Number	3
Length	mm	153
Unit width	mm	45 + 9

Technical data

Main conducting paths

Rated impulse withstand voltage	U_{imp}	V AC	6000
Overvoltage category/pollution degree			III/3
Rated operational voltage	U_e	V AC	690
Rated uninterrupted current	I_u	A	63

Design verification as per IEC/EN 61439

Technical data for design verification			
Rated operational current for specified heat dissipation	I_n	A	63
Heat dissipation per pole, current-dependent	P_{vid}	W	1.7
Equipment heat dissipation, current-dependent	P_{vid}	W	5.1
Static heat dissipation, non-current-dependent	P_{vs}	W	0
Heat dissipation capacity	P_{diss}	W	0
Operating ambient temperature min.		°C	-25
Operating ambient temperature max.		°C	55
IEC/EN 61439 design verification			
10.2 Strength of materials and parts			
10.2.2 Corrosion resistance			Meets the product standard's requirements.
10.2.3.1 Verification of thermal stability of enclosures			
10.2.3.2 Verification of resistance of insulating materials to normal heat			Meets the product standard's requirements.
10.2.3.3 Verification of resistance of insulating materials to abnormal heat and fire due to internal electric effects			Meets the product standard's requirements.
10.2.4 Resistance to ultra-violet (UV) radiation			Meets the product standard's requirements.
10.2.5 Lifting			Does not apply, since the entire switchgear needs to be evaluated.
10.2.6 Mechanical impact			Does not apply, since the entire switchgear needs to be evaluated.
10.2.7 Inscriptions			Meets the product standard's requirements.
10.3 Degree of protection of ASSEMBLIES			Does not apply, since the entire switchgear needs to be evaluated.
10.4 Clearances and creepage distances			Meets the product standard's requirements.
10.5 Protection against electric shock			Does not apply, since the entire switchgear needs to be evaluated.
10.6 Incorporation of switching devices and components			Does not apply, since the entire switchgear needs to be evaluated.

10.7 Internal electrical circuits and connections		Is the panel builder's responsibility.
10.8 Connections for external conductors		Is the panel builder's responsibility.
10.9 Insulation properties		
10.9.2 Power-frequency electric strength		Is the panel builder's responsibility.
10.9.3 Impulse withstand voltage		Is the panel builder's responsibility.
10.9.4 Testing of enclosures made of insulating material		Is the panel builder's responsibility.
10.10 Temperature rise		The panel builder is responsible for the temperature rise calculation. Eaton will provide heat dissipation data for the devices.
10.11 Short-circuit rating		Is the panel builder's responsibility. The specifications for the switchgear must be observed.
10.12 Electromagnetic compatibility		Is the panel builder's responsibility. The specifications for the switchgear must be observed.
10.13 Mechanical function		The device meets the requirements, provided the information in the instruction leaflet (IL) is observed.

Technical data ETIM 8.0

Low-voltage industrial components (EG000017) / Phase busbar (EC000215)		
Electric engineering, automation, process control engineering / Low-voltage switch technology / Component for low-voltage switching technology / Phase busbar (ec@ss10.0.1-27-37-13-06 [ACN992011])		
Number of phases		3
Number of poles		3
Suitable for number of devices		3
Module width	mm	54
Cross section	mm ²	0
Length	mm	155
Width in number of modular spacings		8.5
Rated permanent current I _u	A	63
Type of electric connection		Fork
Insulated		Yes
Rated surge voltage	kV	6
Conditioned rated short-circuit current I _q	kA	0
Max. rated operation voltage U _e	V	690
Rated short-time withstand current I _{cw}	kA	0
Suitable for devices with N-conductor		No
Suitable for devices with auxiliary switch		No
Colour		Black

Approvals

Product Standards		UL 508; CSA-C22.2 No. 14; IEC60947-4-1; CE marking
UL File No.		E36332
UL Category Control No.		NLRV
CSA File No.		98494
CSA Class No.		3211-06
North America Certification		UL listed, CSA certified
Specially designed for North America		No

Dimensions

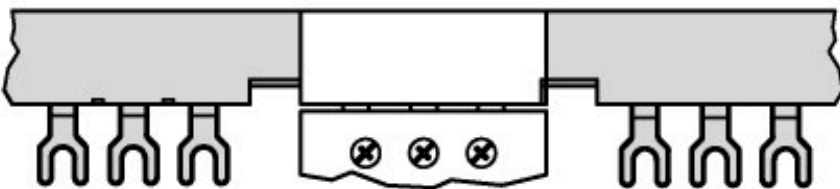
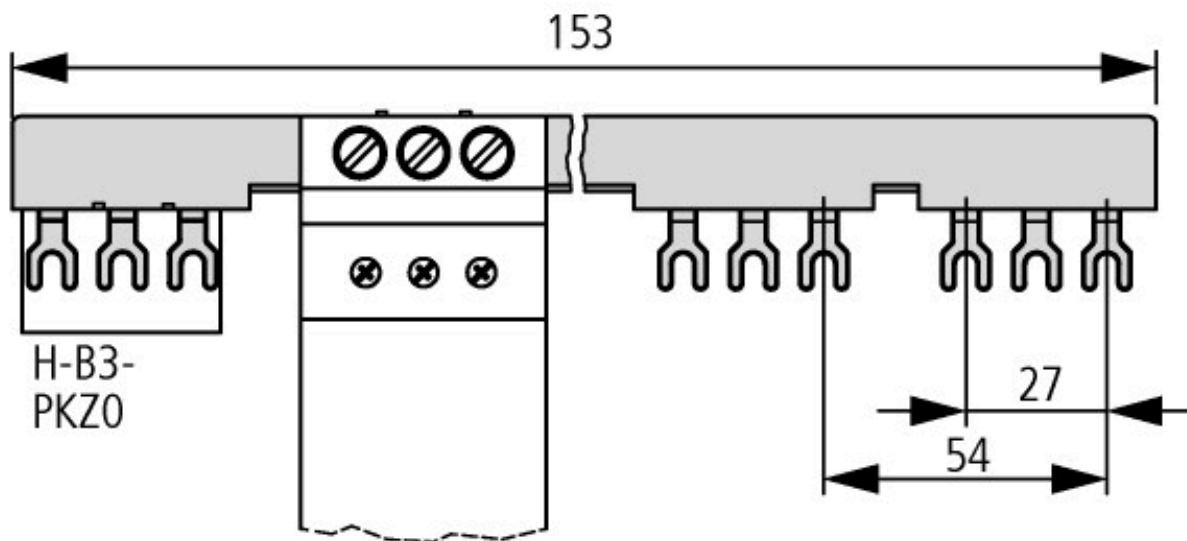

Three-phase commoning link

Additional product information (links)

Motor starters and "Special Purpose Ratings" for the North American market

http://www.eaton.eu/ecm/groups/public/@pub/@europe/@electrical/documents/content/pct_3258146.pdf

Busbar Component Adapters for modern Industrial control panels

http://www.moeller.net/binary/ver_techpapers/ver960en.pdf