

18U 550mm Deep Wall Data Cabinet

Product Ref: **EM04.046**

Technical Features:

- Exquisite design with precise dimension & craftsmanship
- Quick release removable/reversible and lockable smoked-grey glass front door
- Lockable/removable side panels
- Wall mounted or floor standing
- Loading capacity: 60KG
- Top and bottom cable entries
- Easy install and maintenance via removable door and side panels
- Electro-static powder coated door and panels
- Optional accessories



Product Specification

Cable Entry	Top and Bottom
Colour	Black
Compliance	UKCA, CE
Door Type	Quick Release Removable Reversible/Lockable Smoked-grey Glass
Lockable	Yes
Material	0.8mm cold rolled steel
Mounting	Wall / Floor standing
Product Range	Data Cabinets
Size	18U
Supplied With	x4 Vertical Mounting Rails, x4 Horizontal L-rails (Pre-fitted at 19" wide)
Weight	28.000kg
Depth	550mm
Height	905mm
Width	600mm

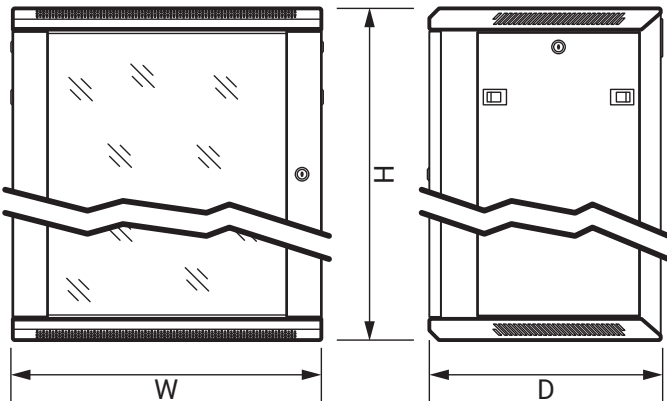

Errors and omissions excepted (E&OE). All information is subject to change without notice and is correct at the time of print. Refer to issue number and date below.

Tel: +44 (0)1302 765 570 • info@emitex.co.uk • EmitexInfo