



# ENER-J®

Smart Home Living

## Wireless Kinetic Switches & Receiver Modules



Press with a finger to produce kinetic energy



Internal module collects kinetic energy



Kinetic energy is converted into electricity



Communication module transmits signal



Receiver controls the light

## Why Wireless Kinetic Switches?

### Innovation of Wireless Kinetic Technology

The ENER-J wireless switch has a built-in micro energy generator. When the switch is pressed the kinetic system transforms the movement into energy. This transmits a signal to the receiver to turn the lamp or other load on or off. This solves the issue of having to install switch wiring which has been a problem ever since the invention of the lamp.

### No Wiring. No Battery. Easy Installation and Usage

There is no longer a need to install back boxes, make holes or channel out for switch lines in the wall if you use the ENER-J wireless switch. It can be installed/placed anywhere you want: glass, marble, ceramic tile and other smooth, surfaces, etc. The ENER-J switch is safe, surface at wall such as painted wall convenient and extremely simple to install and use

### Collection of Micro Mechanical Energy

Micro energy acquisition (MEA) module constantly generates energy, thus eliminating the need for a battery or mains power supply

### Low power hardware and highly reliable communication protocol

Energy produced by the ENER-J device is very small, so the communicating hardware adheres to strict requirements on low power consumption, wireless transmission and creates a highly stable environment

### Multiple light switches connectable

A receiver can be connected with up to 10 switches and vice versa. This allows you to operate a light source with multiple switches. Quite simply as additional switches to existing light switches. Stepless dimming function and storage brightness.

### Range and Usage

The effective range between transmitter and receiver (not included in the package) is approximately 30 meters indoors and approximately 100 meters outdoors. Ideal to control your garden house, outdoor lighting from the comfort of the house!

# Wireless Kinetic Switch, ECO Series



## ENER-J Switch Advantages

- No Wires** - Through a wireless control terminal, such as the light or motor.
- No Power Supply** - Does not need any power cords, batteries or whatever power source.
- Energy Saving** - Reduce PVC tubing, wiring and cutting walls.
- Eco-friendly** - Reduces battery usage, renovation waste and noise, and CO2 emission.
- Save Money** - Reduce manual labor, decrease construction costs by 30%, Speed up progress by 40%.
- Simple and Convenient** - Free installation; can randomly alter the installation location for the young and old to use.
- Safety** - Waterproof so perfect to use in bathrooms where you don't need to worry about voltage regulations since these are volt free.
- Smart** - Can pair up connection, control at will, and dock with smart home system
- Durable** - Wireless kinetic switches does not use batteries, creates no wear and tear, and can be used for 60 years.

### Technical Parameters

Power Mode	Kinetic energy; Self powered
Work Type	86 Push button type
Voltage	NA
Gang	1 Gang / 2 Gang / 3 Gang
Colour	White, Silver, Black
Operating Temperature	-20°C~60°C
Distance	Up to 20m Indoors and up to 80m outdoors
Rated Life-span	100,000hrs
Communication	RF 433Mhz
Connection	Wi-Fi 2.4GHz
Product Size	86*86*15mm
Product Weight	72g

### Switches

SKU	Gang	Dimmable	Colour	EAN
WS1050X	1 Gang	Yes/No	White	5060774550113
WS1051X	2 Gang	Yes/No	White	5060774550120
WS1052X	3 Gang	Yes/No	White	5060774550137
WS1050XS	1 Gang	Yes/No	Silver	5060774550823
WS1051XS	2 Gang	Yes/No	Silver	5060774550847
WS1052XS	3 Gang	Yes/No	Silver	5060774556481
WS1050XB	1 Gang	Yes/No	Black	5060774550830
WS1051XB	2 Gang	Yes/No	Black	5060774550854
WS1052XB	3 Gang	Yes/No	Black	5060774556467
WS1066	1 Gang Key fob	No	Black	5060774550922
WS1058	2 Gang Key fob	No	Black	5060774556443

# ECO Series Receiver Modules for Kinetic Switches

## Dimmable/Non Dimmable Receiver for Wireless Switch

Simply use this receiver module in any lighting circuit and pair it with Wireless Switches easily



Press with a finger to produce kinetic energy

Internal module collects kinetic energy

Kinetic energy is converted into electricity

Communication module transmits signal

Receiver controls the light

The ENER-J wireless controller with a high-efficiency switching power supply has a wide voltage range with excellent stability and durability. The controller has a load capacity of 5A or 10A on non-dimmable and 100W on Dimmable, depending on the model. The ENER-J wireless controller is equipped with an in-rush current suppression function thus creating a safe and durable product. In order to prevent accidental short-circuit the controller is designed with a replaceable fuse. Even if a short-circuit occurs the fuse will immediately protect the controller from damage

## Diagram

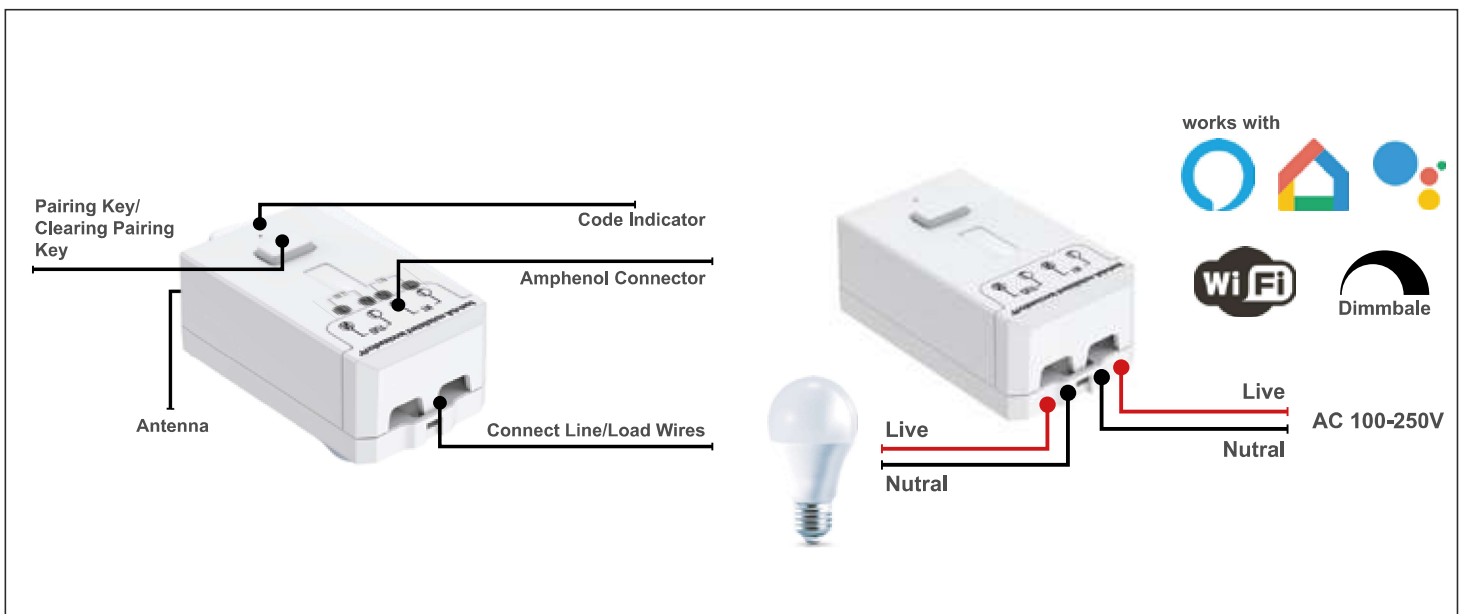

## Features:

- Advanced RF technology, multiple algorithms ensure telecommunication stability.
- Uses 32-bit device ID, 4 billion keys, therefore chance of miss control is extremely low
- For each press and radio transmission, the channel is occupied by the wireless signal for only 1 millisecond, and each transmission is done with 3 septal frames; the control is stable and reliable.
- A receiver can pair with several switches to accomplish 1-2 way switch system ,3- way switch system, Multi-way switch system ( MAX 10 switches )
- Compatible any lamps like halogen, incandescent, CFL, fluorescent, LED.
- Small receiver easily fits into wiring boxes and has built-in fuse & self-protected.

Technical Parameters	
Power Mode	Kinetic energy; Self powered
Work Type	86 Push button type
Voltage	AC 100-250V
Gang	NA
Colour	White
Operating Temperature	-20°C~50°C
Distance	Up to 20m Indoors and up to 80m outdoors
Communication	RF 433Mhz
Connection	Wi-Fi 2.4GHz
Product Size	64*32*24mm
Product Weight	35g

Receivers				
SKU	Max Watts	RF/ Wi-Fi	Dimmable	EAN
WS1055X	5A (LED 500W)	RF	No	5060774553220
WS1056X	1.5A (LED 150W)	RF + Wi-Fi	Yes	5060774553268
WS1079X	1A	RF	Yes	5061004712318
WS1057X	5A (LED 500W)	RF + Wi-Fi	No	5060774553244
WS1065	10A (LED 1000W)	RF	No	5060774550915
WS1071	5Ax2	RF	No	5060774555507
WS1072	5Ax2	RF + Wi-Fi	No	5060774555521

WS1056X and WS1057X also compatible with



# Mini Receivers



Can be paired with up to 6 kinetic switches



Easy Pairing

## Technical Parameters

SKU	WS1055M
Power Consumption	<0.1W
Working Temperature	-20°C - 50°C
Storage Capacity	10 switch-keys
Power Model	AC 100-240V, 50/60 Hz
Distance	30m(indoor), 80m(outdoor)
Colour	White
Rated Current	5A
Weight	32g
Comm	ASK / 433MHz
Dimension	L44xW44xH22mm

## Mini Non-Dimmable Receiver



## Technical Parameters

SKU	WS1056M
Power Consumption	<0.1W
Working Temperature	-20°C - 50°C
Storage Capacity	10 switch-keys
Power Model	AC 100-240V, 50/60 Hz
Distance	30m(indoor), 80m(outdoor)
Colour	White
Max Power	4 - 100W
Weight	32g
Comm	ASK / 433MHz / WiFi 2.4G
Dimension	L44xW44xH22mm

## Mini Dimmable Receiver



works with



**Technical Parameters**

SKU	WS1057M
Power Consumption	<0.1W
Working Temperature	-20°C - 50°C
Storage Capacity	10 switch-keys
Power Model	AC 100-240V, 50/60 Hz
Distance	30m(indoor), 80m(outdoor)
Colour	White
Rated Current	5A
Weight	32g
Comm	ASK / 433MHz / WiFi 2.4G
Dimension	L44xW44xH22mm

**Mini Non-Dimmable  
RF + WiFi Receiver**



works with



**Wiring diagram**

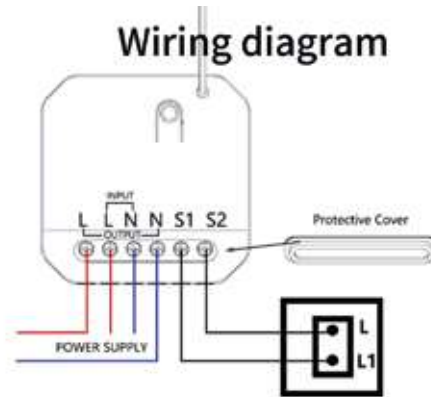

Terminals S1 and S2 can be left disconnected if the switch is not needed with traditional wiring.

**Wireless Grid Switch**



Self Powered



No Radiation



No Maintenance



No Wiring

SKU	Product Details	Size (LxWxH)
WS1070	1 Gang MK Logic Style White	60x25x27mm
WS1070B	1 Gang MK Logic Style Black	60x25x27mm
WS1073	1 Gang Click MiniGrid Style White	49x16x24mm
WS1073B	1 Gang Click MiniGrid Style Black	49x16x24mm
WS1083	1 Gang Click MiniGrid Style Antique Brass	49x16x24mm
WS1084	1 Gang Click MiniGrid Style Satin Chrome	49x16x24mm
WS1085	1 Gang Knightsbridge, white (Dimmable)	55x25x27mm
WS1081	1 Gang BG Style White	54x27x25mm
WS1082	1 Gang HAGER Style White	54x27x25mm

- Wireless Grid Switch Compatible with MK/Click Mini Grid system
- Can be used alongside mains voltage grid switches.







IP65



Dimmable

  
Press with a finger to produce kinetic energy

  
Internal module collects kinetic energy

  
Kinetic energy is converted into electricity

  
Communication module transmits signal

  
Receiver controls the light

## 1G Wireless Kinetic Switch + 5A RF Receiver Bundle Kit

Technical Parameters	
SKU	WS1060X
Power	5A
Voltage	AC 100-250V
Colour	White
Operating Temperature	-20°C~55°C
Distance	Up to 20m Indoors and up to 80m outdoors
Communication	ASK / 433MHz
Connection	Wi-Fi 2.4GHz
Product Size	S: 86*86*15mm; R: 64*32*24mm
Product Weight	Switch: 72g / Receiver: 35g
Packing Dimension	250*150*40mm







IP65



Dimmable



Wi-Fi

  
Press with a finger to produce kinetic energy

  
Internal module collects kinetic energy

  
Kinetic energy is converted into electricity

  
Communication module transmits signal

  
Receiver controls the light

## 1G Wireless Kinetic Switch + 1.5A RF+Wi-Fi Receiver Bundle Kit

Technical Parameters	
SKU	WS1061X
Power	1.5A
Voltage	AC 100-250V
Colour	White
Operating Temperature	-20°C~55°C
Distance	Up to 20m Indoors and up to 80m outdoors
Communication	ASK / 433MHz / Wi-Fi 2.4GHz
Connection	Wi-Fi 2.4GHz
Product Size	S: 86*86*15mm; R: 64*32*24mm
Product Weight	Switch: 72g / Receiver: 35g
Packing Dimension	250*150*40mm







IP65



Non Dimmable



Wi-Fi

  
Press with a finger to produce kinetic energy

  
Internal module collects kinetic energy

  
Kinetic energy is converted into electricity

  
Communication module transmits signal

  
Receiver controls the light

## 1G Wireless Kinetic Switch + 5A RF+Wi-Fi Receiver Bundle Kit

Technical Parameters	
SKU	WS1062X
Power	5A
Voltage	AC 100-250V
Colour	White
Operating Temperature	-20°C~55°C
Distance	Up to 20m Indoors and up to 80m outdoors
Communication	ASK / 433MHz / Wi-Fi 2.4GHz
Connection	Wi-Fi 2.4GHz
Product Size	S: 86*86*15mm; R: 64*32*24mm
Product Weight	Switch: 72g / Receiver: 35g
Packing Dimension	250*150*40mm

\*Only Switches are wireless and IP65 Rated. Receivers are only for internal use and need to be wired into a circuit

### 30W LED Floodlight PRE-Wired with 500W ECO range Receiver



Technical Parameters	
SKU	EWS 1067
Dimensions	144×125×26.3 mm
Power	30W
Voltage	220-240V AC
CCT	6500k
Lumens	2400Lm
Weight	2.3Kgs
Beam Angle	110°
Warranty	2 Years

### 50W LED Floodlight PRE-Wired with 500W RF Receiver



Technical Parameters	
SKU	EWS 1068
Dimensions	190×151×27mm
Power	50W
Voltage	220-240V AC
CCT	6500k
Lumens	4000Lm
Weight	2.3Kgs
Beam Angle	110°
Warranty	2 Years

### 50W LED Floodlight PRE-Wired with 500W WiFi+RF Receiver



Technical Parameters	
SKU	EWS 1069
Dimensions	190×151×27mm
Power	50W
Voltage	220-240V AC
CCT	6500k
Lumens	4000Lm
Weight	2.3Kgs
Beam Angle	110°
Warranty	2 Years

\*Only LED Floodlights are IP65 rated. The receivers are not Ip rated and need to be enclosed in a waterproof box.

**ENER-J Controller Wireless Systems**

The wireless ENER-J energy switch and wireless receiving controller can be paired with any combination: a controller can be controlled by a maximum of 10 separate switches, a switch can pair an unlimited number of controllers.

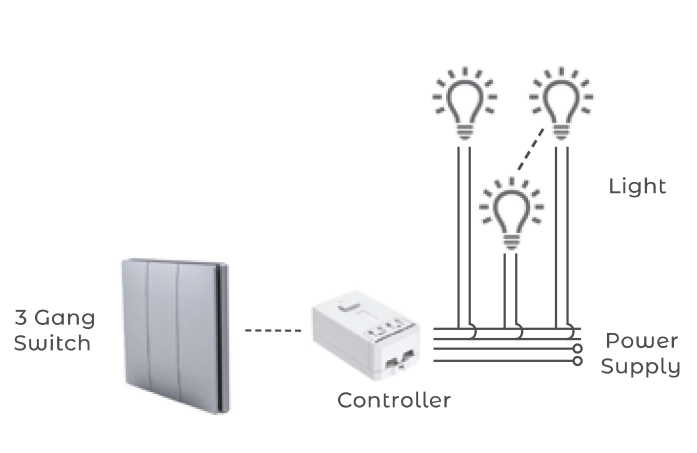
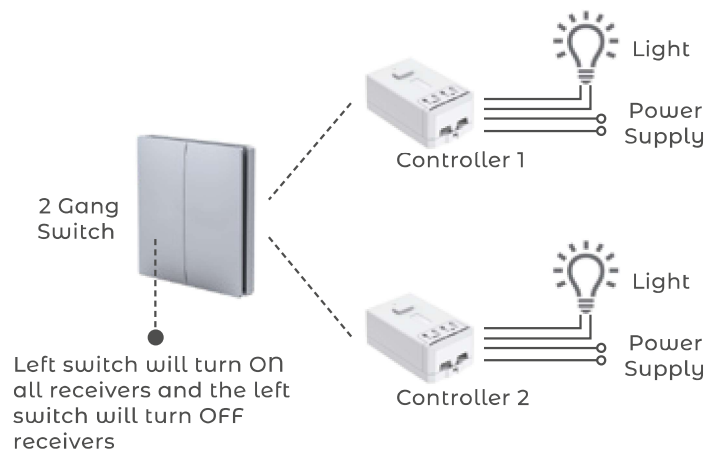
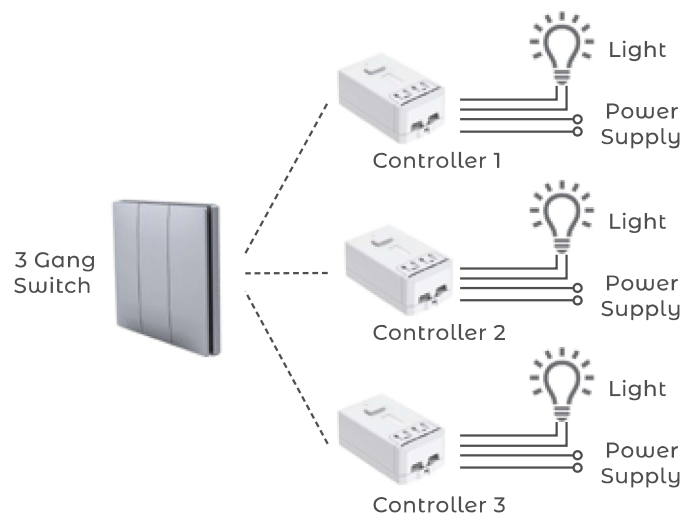
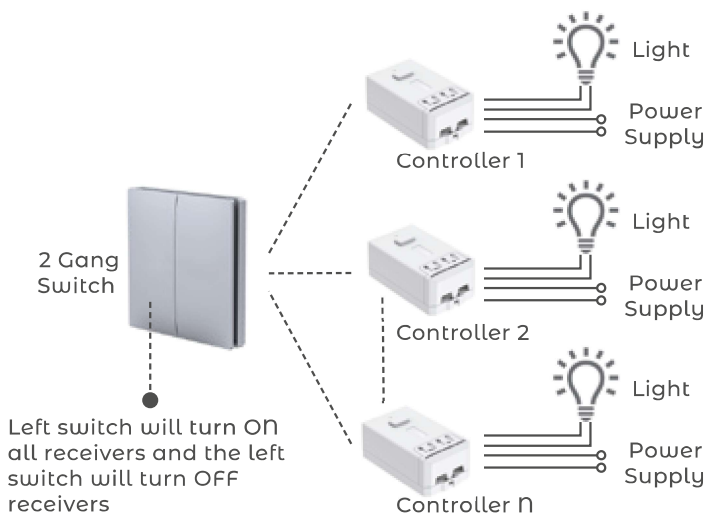
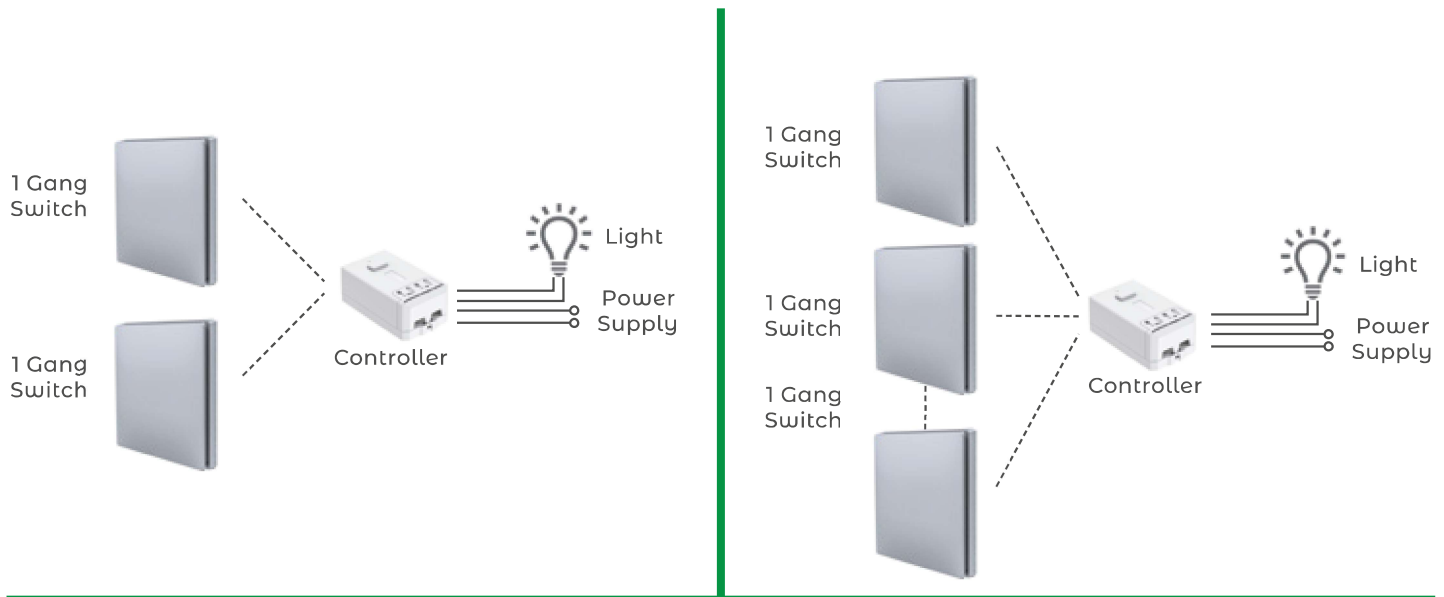

**Waterproof IP65**  
Dustproof & Waterproof Durable



---

### Thank you for choosing ENER-J!

Customer satisfaction is our TOP priority, please let us know how you felt about your experience. Happy?

We are so happy that you are pleased with our product. Feel free to express your newfound joy! Share your experience by writing a review.

Not Happy? If you are not fully satisfied with the item you received, have any problems like damages, or questions, please contact us. We typically respond within 24-48 hours.

### Stuck? Confused?

Contact our Technical Support team on:

T: +44 (0)1291 446 105 E: [support@ener-j.co.uk](mailto:support@ener-j.co.uk)

Lines are open Mon - Fri (8am to 4pm)