

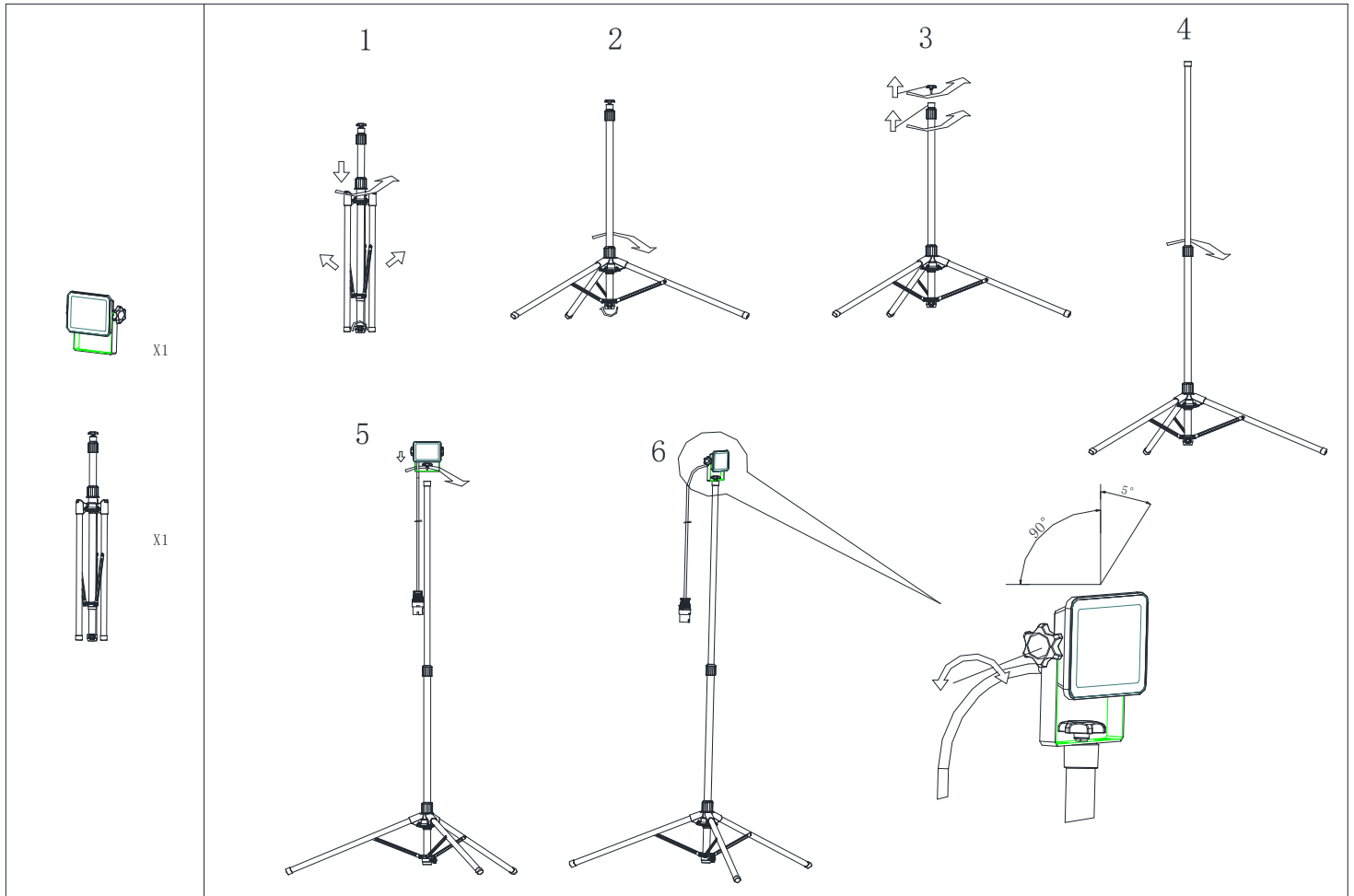

LED Worklight

Type: GX-SLST110V10W

SECTION ONE: INSTALLATION AND FUNCTION



SECTION TWO SITING INSTRUCTION

- Check the pack and make sure you have all of the parts listed.
- Decide on the appropriate location for your product.
- This product is suitable for outdoor.
- This product is rated IP44. It is suitable for outdoor use but should not be immersed in water or subjected to standing water.

Warning: This appliance can be used by children aged from 8 years and above and persons with reduced physical, sensory or mental capabilities or lack of experience and knowledge if they have been given supervision or instruction concerning use of the appliance in a safe way and understand the hazards involved. Children shall not play with the appliance.

- The light source of this luminaires is not replaceable; when the light source reaches its end of life the whole luminaire must be replaced.
- Caution: Do not stare directly at the LED light beam.
- Check the cable, plug and the unit for any damage, if damaged DO NOT use the luminaire.

- Screw must be locked tight
- Never modify the luminaire, there are no user serviceable parts inside.
- Repairs should only be carried out by a suitably qualified person.
- Regular cleaning of luminaire should be carried out at regular intervals not only to ensure good optical performance but also ensure that dirt does not accumulate to such an extent as to impair the electrical or thermal safety of the fitting. This should be done with the luminaire switched off/isolated and a soft damp cloth should be used, do not use any chemicals or abrasives.

SECTION THREE SPECIFICATIONS

Model No.:	GX-SLST110V10W
Voltage	110VAC 50/60Hz
Current:	0.16A
Power:	10W
Lumen Output:	800lm
Colour Temp:	5000K
Protection class (body)	IP65
Protection class (including cable & plug).	IP44
Weight	Approx. 3.2KG
Dimension(WxDxH)	1.8(H)*1.242(D)mm

Light Source Maintenance:

The light source of this luminaire is not replaceable; in case the light source needs to be replaced (e.g. at the end of its life), the whole luminaire shall be replaced.

Environment:

Please do not dispose the packaging as unsorted waste, use the recycling facilities provided by your local authorities.

When the light fitting comes to the end of its life or you choose to update or upgrade by replacing it, then do not dispose with your normal household waste. Please recycle where facilities exist. When you need to dispose of this fitting, check with your retailer or local authority for suitable options.

Due to our policy of continuous improvement we reserve the right to change specification without prior notice. Errors and omissions excepted. These instructions have been carefully checked prior to publication. However, no responsibility can be accepted by Engex for any misinterpretation of these instructions.

Engex

10 Sandersons Way,
Blackpool, FY4 4NB

Email: enquiries@engex-uk.co.uk

Web: www.engex-uk.co.uk

