

## 25.4mm No.10 PVC / SWA Cable Cleat

Product Ref: **NO.10**

### Technical Features:

- Single fixing cable cleat provides a simple, but strong means of securing cables
- Protect cables from damage, vibration and chafing due to excessive movement
- Provides strain relief
- Corrosion resistant
- Suitable for SWA and heavy duty cables

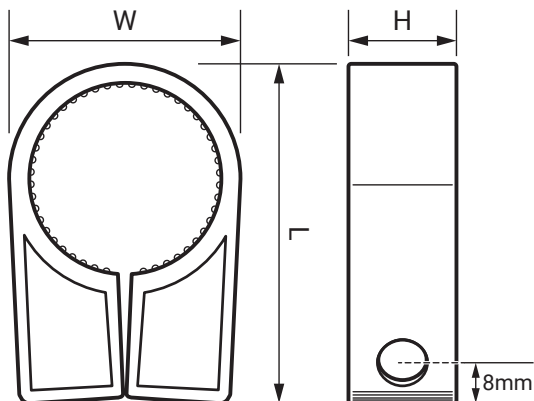

## Product Specification

Colour	Black
Compliance	UKCA, CE
Guarantee	1 Year
Material	Low Density Polyethylene
Minimum Cable Diameter Ø	22.7mm
Maximum Cable Diameter Ø	25.4mm
Stud Hole Size	M6
Suitable for	SWA and Heavy Duty Cables
Type	No.10
Weight	0.009kg
Height	19mm
Length	45mm
Width	31mm

Errors and omissions excepted (E&OE). All information is subject to change without notice and is correct at the time of print. Refer to issue number and date below.

Tel: +44 (0)1302 765 570 • f4p-products.com • X@F4Pinfo