

10W Protector LED Colour Switchable Floodlight with PIR

Product Ref: **FPF10CC/PIR**

Technical Features:

- Die cast aluminium black powder coated body
- Pre-wired with 1m cable
- Can be installed without removing the bracket
- PIR c/w manual override
- 3CCT (3000K/4000K/6500K)
- Up to 1000 Lumens
- Beam Angle: 110°

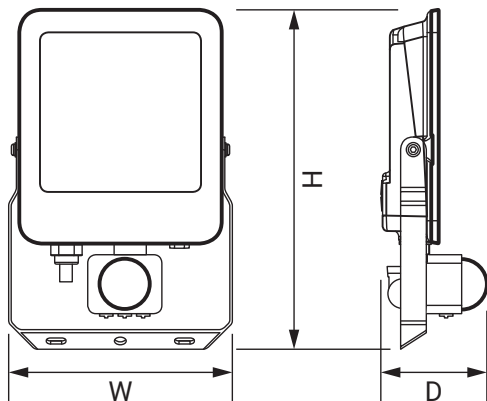

Product Specification

Beam Angle	110°
Cable Length	1m
Class	Class 1
Colour	Black
Colour Temperature	Selectable - 3000/4000/6500 K
Compliance	UKCA, CE
CRI	>80
Detection Angle	120°
Detection Range	2 - 8m
Finish	Powder Coated
Frequency	50/60Hz
Guarantee	3 Years
IP Rating	IP65
Lamp Life (L70/B50)	25000 hours
Lens Colour	Opal
Lumens	1000lm
Material	Die Cast Aluminium
Mounting	Surface
Operating Temperature	-20 - +40°C
Sensor	PIR
Supplied With	1 metre of pre-wired cable and mounting bracket
Timer Adjustment	10secs - 7mins
Voltage Rating	240V
Wattage	10W
Weight	0.510kg
Depth	62mm
Height	201mm
Width	133mm

Errors and omissions excepted (E&OE). All information is subject to change without notice and is correct at the time of print. Refer to issue number and date below.

Tel: +44 (0)1302 769 966 • fusion-luminares.co.uk