



IEC 309 HP: range of plugs and socket-outlets complying with the safety requisites defined by the international Standards IEC 60309-1 and IEC 60309-2 and assimilated at European level as EN 60309-1 and EN 60309-2. This range expands GEWISS's assortment from 16A to 125A straight plugs, straight connectors and 10° flush-mounting socket-outlets with IP44/IP54 and IP66/IP67/IP68/IP69 degrees of protection to ensure full protection for all applications. The technopolymers and thickness used for the parts made of insulating material guarantee an elevated degree of mechanical and chemical agent resistance. All the sleeves and pins of the IEC 309 HP socket-outlets and plugs are surface-treated with nickel-plating to ensure full protection against corrosion, oxidation and abrasion. All the external metallic elements of the IEC 309 HP plugs and socket-outlets are made of stainless steel (the threaded metallic inserts for the body-grip coupling of the 63-125A versions are made of brass).

Colour	Red	Rated current (A)	16
IP degree	IP66/IP67/IP68/IP69	No. of poles	3P+E
Mechanical resistance	IK09	Reference h	6
Type	Straight connector	Rated voltage	380 - 415 V
Frequency	50/60 Hz	Terminal tightening capacity	1-2.5mm ² flexible cables - 1.5-4mm ² rigid cables
Cable clamp tightening capacity	7.5-13.8 mm	Operating temperature	-25 +55 °C
Type of wiring	With screw	Type of material	Halogen-free in compliance with EN 60754-2
Electrocod	2211	Glow wire test	850 °C (active parts) - 650 °C (passive parts)
Total number of operations	> 5000	Permissible overload	22 A
Breaking capacity at 1.1 Un	20 A	Insulation resistance	> 10 MΩ
Thermo-pressure with ball	125 °C (active parts) - 80 °C (passive parts)		

BEHAVIOUR WITH CHEMICAL AND ATMOSPHERIC AGENTS

Saline solution	Acids		Bases		Solvents				Mineral oil	UV rays
	Concentrated	Diluted	Concentrated	Diluted	Hexane	Benzol	Acetone	Alcohol		
Resistant	Not resistant	Limited resistance	Limited resistance	Resistant	Resistant	Resistant	Resistant	Resistente	Resistant	Resistant

DIMENSIONAL

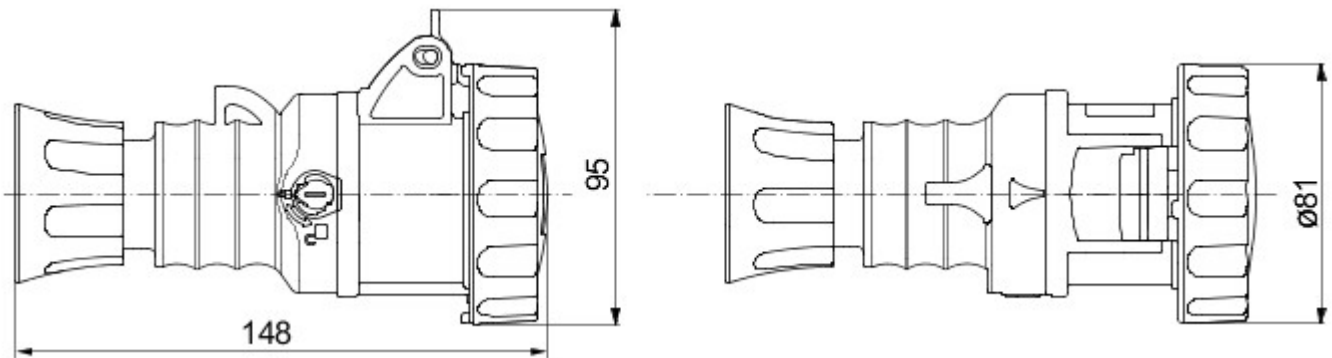

TECHNICAL SYMBOLOGY

IP	IK	INSTALLATION -25 °C min / +55 °C max	With screw	HF HALOGEN FREE	GWT
IP66/IP67/IP68/IP69	IK09			Halogen-free in compliance with EN 60754-2	850 °C (active parts) - 650 °C (passive parts) / 125 °C (active parts) - 80 °C (passive parts)

STANDARDS/APPROVALS

