

The logo for HEATSTORE, featuring the word "HEATSTORE" in a bold, sans-serif font. The letters "HEAT" are red, and "STORE" is grey. To the left of the text is a red graphic consisting of five horizontal bars of varying lengths, resembling a stylized flame or heat waves. The entire logo is enclosed in a red rounded rectangular border.

Installation & Control Guide for Low Surface Temperature Panel Heaters with Intelligent Fan Control & Electronic 7-Day Timer

Models

HSP500LST, HSP750LST, HSP1000LST, HSP1500LST

All electrical appliances produced for the Company are guaranteed for two years against faulty material or workmanship. This applies only if the appliance has been used for purposes in accordance with the instructions provided and has not been connected to an unsuitable electricity supply, or subject to misuse, neglect, damage or modified or repaired by any person not authorised by us. This guarantee is offered to you as an extra benefit and does not affect your legal rights.

The correct electricity supply voltage is shown on the rating label attached to the appliance.

Reasonable care has been taken to ensure that this guide is accurate at the time of printing. In the interest of progress the Company reserve the right to vary specifications from time to time without notice.

General Safety

Our Low Surface Temperature heaters have been designed and built to the NHS requirement for safe surface temperatures which is that no surface which can be touched by the user will be more than 43 °C (at a room temperature of 21 °C) This means that our Low Surface Temperature heaters out-perform the European Standard by a significant margin.

The appliance is not intended for use by persons (including children) with reduced physical, sensory or mental capabilities or lack of experience and knowledge unless they have been given supervision or instruction concerning use of the appliance by a person responsible for their safety. Children should be supervised to ensure that they do not play with the appliance.

Safety Monitor

As part of the intelligent control (see section 15), the heater has built-in safety monitoring. In the unlikely event of a fault, the safety monitoring will help prevent high surface temperatures. The safety monitor will identify overheating, fan failure and certain electronic faults. When the safety monitor identifies a fault, the heater runs in restricted mode. However, in the event of a serious fault the heater stops running. The heater indicates a fault by beeping twice. It will not beep again until the unit is switched off and then back on, but the LED will flash red continuously.

Thermally Operated Cut-Out

The appliance is fitted with a thermally operated cut-out (TOC). In the unlikely event that the safety monitor fails, this safety device will switch the heater off if the appliance overheats. If the TOC has tripped there is a high possibility the heater is faulty and should be checked by a qualified person. The TOC can only re-set after the appliance has cooled down, however we advise not to do this until the heater has been checked

In order to re-set the TOC, proceed as follows:

- Switch off appliance and leave for approximately 10 minutes.
- Switch appliance back on and the TOC will re-set.
- Ensure that the appliance is functioning correctly. If the TOC

control operates again, the appliance should be checked by a qualified person.

The heater carries a 'Do Not Cover' label to warn the user that if the appliance is covered, there is a risk of overheating.

Warning

- Do NOT site the appliance in a corner.
- Do NOT handle the appliance with wet hands.
- Do NOT use the appliance in workshops or rooms where excessive dust is generated or present.
- Ensure that nothing is pushed into the air outlet of this appliance.
- Do NOT touch outlet grille when the appliance is in use.
- Do NOT cover or restrict the appliance when in use.
- Do NOT use the appliance if damaged.
- Do NOT leave the appliance unattended where young children are present.
- This appliance must be earthed.

Installation

Mounting bracket

This unit must be installed using the mounting bracket and chains provided. The chains are used to prevent the unit from being dropped when the securing screws are loosened. This means the securing screws can simply be loosened to view behind the heater. This allows the rating label to be viewed easily and also makes it easier to clean the unit. Full installation instructions can be found on page 6, section 19.

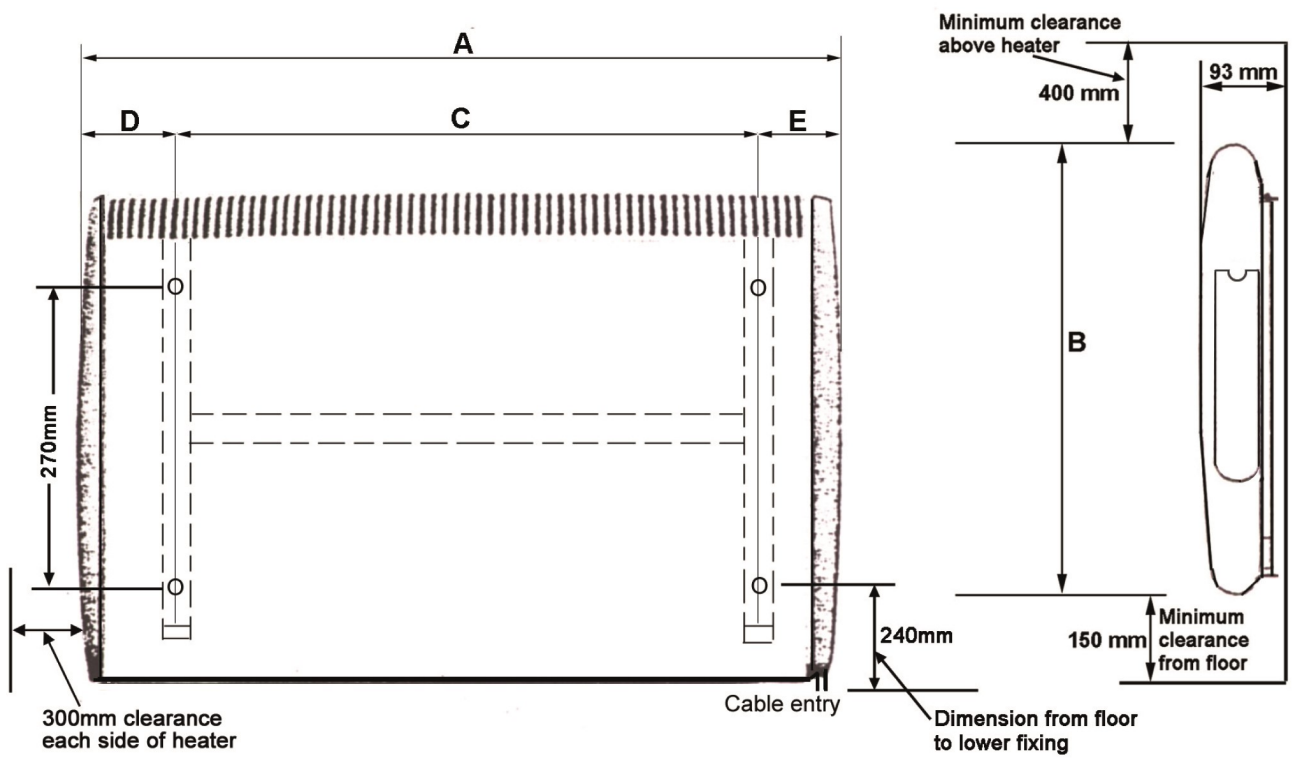

MILLIMETRES					
	WATTS	A	B	C	D/E
HSP500LST/HSP750LST	500/750	506	430	210	148
HSP1000LST	1000	640	430	364	138
HSP1500LST	1500	892	430	616	138

See diagram below for Mounting

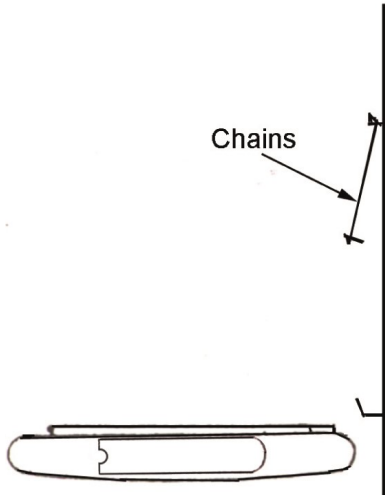

Fig 1

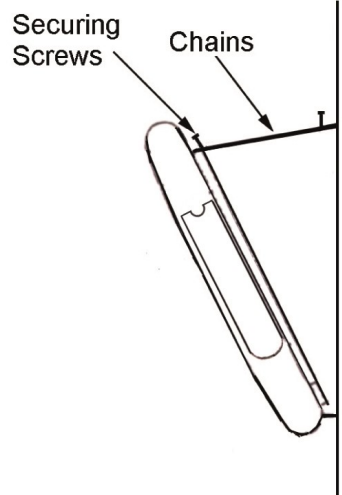

Fig 2

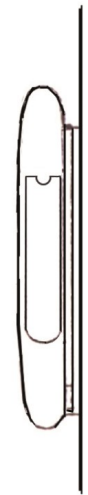
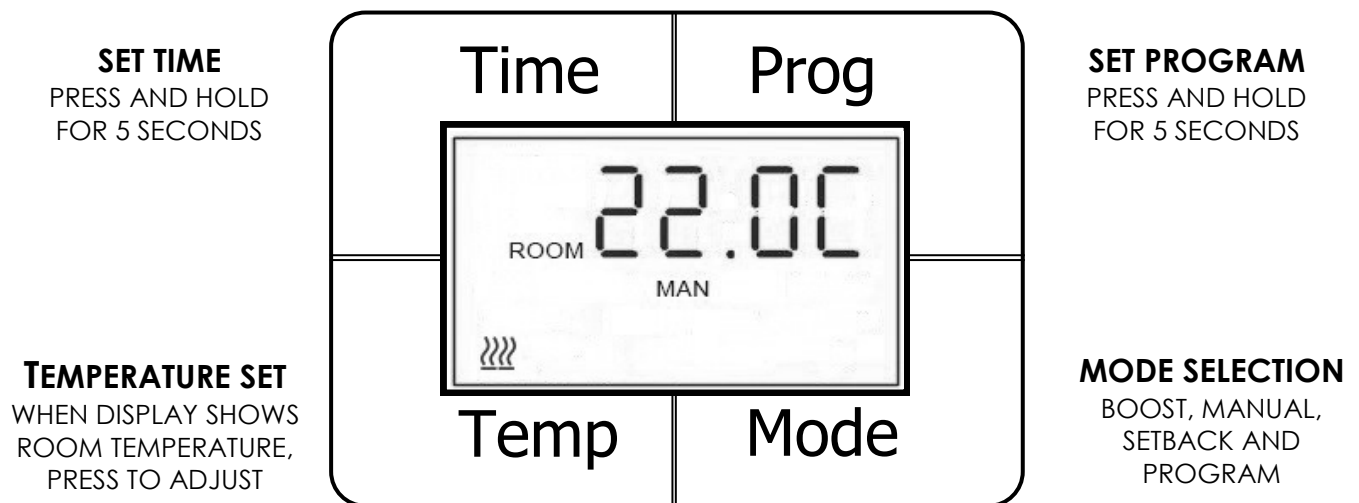

Fig 3

Note: The heater must be secured using the securing screws as per Figures 1 to 3 before being switched on.



1. Basic Operation

When the appliance is connected to the mains supply and the wall socket is switched 'ON', the LED indicator on the front of the appliance will light up green, showing that the power is available to the unit. Before you can use the HSP-LST, it has to be activated by pressing any control button. The LCD backlight will turn on. To operate any control button, press within 2 seconds of activation.

2. Time and day setting

-Press and hold the TIME button for 5 seconds.

Minutes display flashes - use TEMP and MODE buttons to set minutes.

-Press TIME button

Hours display flashes - use TEMP and MODE buttons to set hours.

-Press TIME button

Day display flashes - use TEMP and MODE buttons to set Day.
Press TIME to return to main screen.

3. Selecting operating mode

The HSP-LST has 4 operating modes:
BOOST, MANUAL, SET BACK, PROGRAM.

Each mode can be selected by pressing the MODE button to cycle through the options. The cycle sequence will always start with BOOST mode followed by MANUAL, SET BACK and PROGRAM.

4. BOOST - Runback timer

The boost feature increases the room temperature for a pre-set amount of time ranging from 15 minutes to 4 hours. The timer is set to 15 minutes by default. To increase this, press the TIME button whilst in BOOST mode, and then use the PROG button to increase the timer in 15 minute increments. After it reaches 4 hours and PROG is pressed again, the timer resets to 15 minutes.

To amend the set temperature when in BOOST mode, simply activate the display by pressing any button. Press TEMP, then use TEMP and MODE to change the temperature. Once the temperature is set, you can leave the display to return to the main screen and the settings will be saved. After the time is up, the appliance will return to previous operating mode.
(Temperature range is 15°C-35°C)

5. MAN - Manual Mode

In manual mode, the heater maintains the set temperature.

To amend the set temperature when in Manual mode, simply activate the display by pressing any button. Press TEMP, then use TEMP and MODE to change the temperature. Once the temperature is set, leave the display to return to the main screen and the settings will be saved.

(Temperature range is 15°C-35°C)

6. SETB - Setback Mode

Setback mode can be used for frost protection, situations where a minimum room temperature must be maintained, or to disable the heating completely.

To amend the set temperature when in Setback mode, simply activate the display by pressing any button. Press TEMP, then use TEMP and MODE to change the temperature. Once the temperature is set, leave the display to return to the main screen and the settings will be saved. When the room temperature drops below the set temperature the heating will be active. (Temperature range is 4°C-15°C or off)

To disable heating, lower the temperature to below 4°C and the screen will show '---'. The heating is now disabled.

7. PROG - Automatic time mode

In this mode, the appliance will follow the week's time / temperature program.

You can temporarily override the temperature in PROG mode by simply activating the display, entering program mode and pressing the TEMP button, then using the TEMP and MODE buttons to set the new temperature. The new set temperature will then be maintained until the next program step.

(Temperature range is 4°C-35°C or off)

8. Fan only mode

This appliance comes with a fan only option. This is very good for the warmer months to help improve air circulation. To enter fan only mode, activate the display and then hold down the MODE button for 5 seconds. The display will then show a fan symbol and the word 'FAN'. To exit fan only mode simply activate the display and press the MODE button.

An example of one day program on HSP-LST

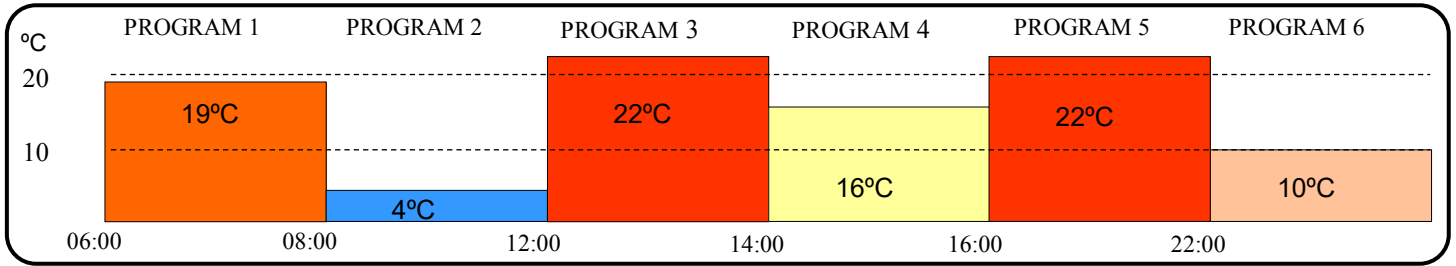

Logic diagram for setting program on HSP-LST

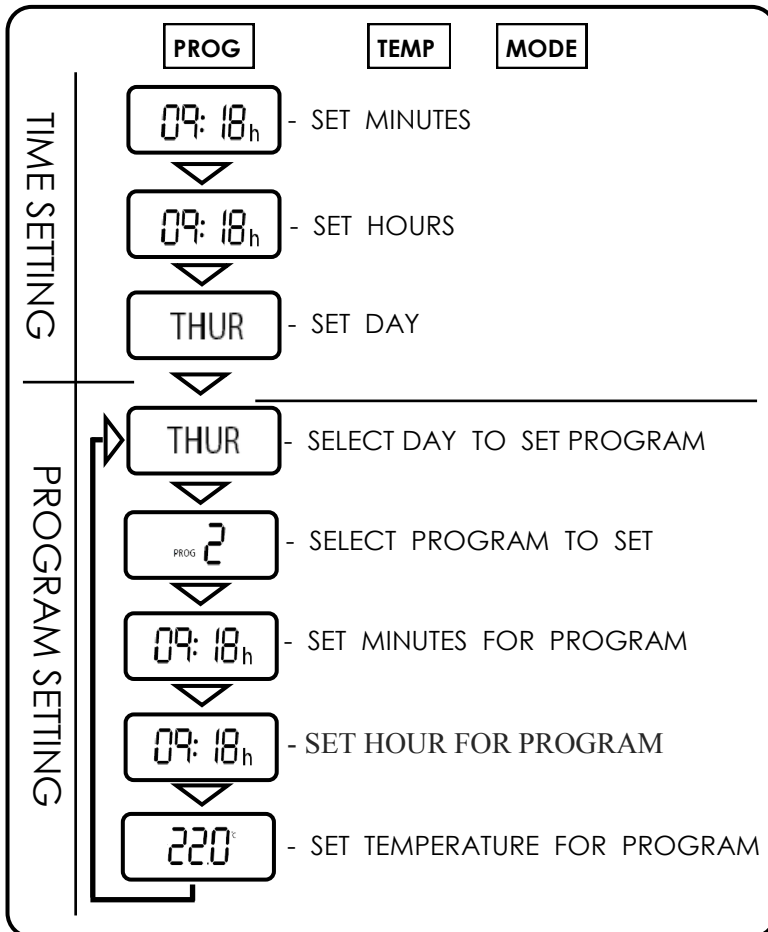

1. Press and hold PROG for 5 seconds to enter the time setting.
2. The day will be flashing.
3. Use TEMP and MODE to navigate day, press PROG to select day.
4. PROG 1 will be flashing. Use TEMP and MODE to navigate program, use PROG to select program.
5. The minutes will be flashing.
6. To set minutes, use TEMP and MODE to change minutes, press PROG to set the minutes.
7. The hour will be flashing
8. To set hour, use TEMP and MODE to change hour, press PROG to set the hour.
9. The temperature will be flashing.
10. To set temperature, use TEMP and MODE to change temperature, press PROG to set temperature.

The HSP-LST has a 7-day timer with up to 6 programming steps available for each day. In the programming you can set a start time and a temperature for each program.

10. Set program inactive

If you do not require the use of all 6 programs they should be set as inactive. When in programming mode select the program you want to make inactive and press the TIME button. If the program is inactive the display will show "- :- -". To activate the program again press the TIME button.

11. Advance mode

Press PROG from PROG mode to bring forward the next program. To clear advance mode, press PROG.

12. Copy day function

If you require the same set of programs throughout the week it is possible to copy all the programs from one day to another.

To do this, when in programming mode press and hold the TIME button and this will bring you to the copy day mode. To select which day you wish to copy press the PROG button and this will cycle through numbers 1-7 on the screen, this relates to which day you would like to copy. 1=MON, 2=TUE, 3=WED etc.

To select which day you would like to copy the programs to, use the TEMP & MODE to navigate to the day. Once both are selected, press the time button to copy the day. The 'To' will flash to indicate this has been done.

13. Heat symbol on the display

Every time there is a demand for heat, the display will show the heat icon.

⏏ - Reduced heat output when the room temperature is close to the set temperature - allows for almost silent operation.

⏏⏏⏏ - full heat output

To add another program repeat steps 2-10.

14. Keys locking

Press and hold TIME and TEMP together for 5 seconds. The display will show  symbol. Repeat the step to unlock.

15. Open Window Detection

Ensuring you don't waste energy on heating the outside world, the heater is equipped with optional open / closed window detection. The heater recognises sudden drops in temperature when a window or a door is opened and turns the heating off to save energy. When the window is closed, the heater will automatically detect a temperature rise, and switch itself back on. Once enabled in the setup menu, the open window detection is fully automatic and does not require any human intervention to be activated.

Setting-up Open Window Detection

The system has been factory set to default time and temperature values. If necessary, all values can be adjusted. When the heating is on, open window detection sensor will automatically switch the heater off when it detects a fall in temperature of 2°C in less than 10 minutes (this temperature can be changed in menu 7 and time in menu 6). If a temperature rise of 2°C in less than 30 seconds is detected, the heater will switch itself back on (this temperature can be changed in menu 9 and time in menu 8).

16. Setup menu

1. Press and hold TEMP and MODE together for 5 seconds.
2. The display will enter the setup menu.
3. Use TEMP and MODE to change a value.
4. Use TIME to scroll between the settings.

01 - temperature calibration

The temperature reading has been factory calibrated but if for any reason it needs adjusting (better accuracy required, to suit different position in the room etc.), the reading can be recalibrated in 0.5 degrees steps.

02 - change between degrees Celsius or Fahrenheit

03 - set minimum temperature
(3.5 deg = frost protection)

When this is set, the heater will operate in any mode should the room temperature fall below the set temperature.

04 - set maximum temperature

When this is set, the maximum temperature in any mode cannot exceed the limit.

05 - open window detection 0 = off, 1 = on



06 - 600 - open window detection time 600 seconds

07 - 2 - temperature drop of 2°C in the detection time

08 - 30 - closed window detection time of 30 seconds

09 - 2 - temperature rise of 2°C in the detection time

17. Status light on the heater

Light colour	Heater status
	STAND-BY No heat output
	Reduced heat output
	Full power heat output

18. Intelligent Fan Control

The intelligent fan control incorporates one of the latest low energy consumption BLDC motors. This allows the heater to operate quietly, whilst still providing the best possible levels of comfort.

Depending on which heat mode is activated, it will calculate the best possible airflow temperature and will adjust the fan speed accordingly. If the heater is running in fan mode only (heat switched off), then the fan will operate at a fixed speed.

NOTE: When turning the heater on, there is a 30 seconds delay until the fan starts running to allow the heater to warm up. After the heater is switched OFF the fan will continue running for a short period of time. When changing the heat mode or fan speed mode, the fan will respond accordingly after a small time delay.

19. Mounting

This unit is for wall mounting only. It is designed to be very quiet in operation if mounted correctly. It must be fitted using the wall bracket supplied and screws for a 5mm hole. The wall bracket provided has been specially designed to minimise noise levels. **Care must be taken when handling the bracket not to bend or distort it.** When fitting more than one heater in a room we would recommend that they are sited on the same wall to optimise airflow and ensure quiet operation.

To wall mount, the wall bracket supplied must be used. Remove the wall bracket from the heater, with the chains attached, by removing the 2 securing screws from the top of the rear panel.

Fix the wall bracket to the wall using 4 screws.

Fig 1: Present the heater to the bracket

Fig 2: Locate the heater onto the bottom lugs via the 2 slots in rear panel. Hinge the heater upwards and attach the chain assembly, then move the heater to the upright position. The link plates should slide under the slotted bracket lip.

Fig 3: Tighten both retaining screws.

MOUNTING ON A PLASTERBOARD WALL

- Ensure at least one of the wall brackets is secured to the timber frame of the studded wall by using standard wood screws.
- Where the bracket is fitted onto plasterboard only, ensure plasterboard fixings are used. Standard wall plugs will not be suitable.
- Where possible mount the heater(s) on an outside wall to inhibit transfer of sound within the building.

NB: Failure to follow the instructions and recommendations provided could result in increased noise levels.

The heater must not be located immediately below a fixed socket outlet.

20 . Connection to the Main Supply

Electrical installation should be carried out by a competent installer, preferably registered with NICEIC (National Inspection Council for Electrical Installation Contracting) in accordance with the 18th edition of the IEE Wiring Regulations, (BS.7671), and any relevant Local Authority By-Laws. This heater is fitted with a 3-core mains supply cable and must be permanently connected to the electricity supply via a double pole switch having 3mm gap on each pole. **There are no exceptions.**

A switched Fused Connection unit to BS.1363. Part 4 is a recommended mains supply connection accessory to ensure compliance with safety requirements applicable to fixed-wiring installation.

Note: When switched on for the first time the appliance may emit a slight smell. This is purely the evaporation of a fluid used in the manufacturing process.

21. If Your Heater Does Not Work

- Check that power is available to the heater. The LED on the front of the heater should be illuminated.
- Check that the thermal cut-out has not operated. Follow the reset instructions given under the section headed 'Thermal Operated Cut-out'.
- Check that the fuse in the spur unit has not blown. This can be done by replacing the fuse with another suitable fuse.

Should none of the above remedies work, then telephone the helpline number shown in these instructions (UK ONLY). Do not attempt to repair the heater.

22. Cleaning

Always disconnect the heater from the mains before cleaning. The heater should not require any maintenance, but it is strongly advised that it is kept clean. An occasional wipe over with a soft cloth is all that should be necessary.

- Do NOT use metal or furniture polish on any part of the heater.
- Do NOT touch the heater with wet hands or in any way bring water into contact with it.

If the supply cord is damaged, it must be replaced by the manufacturer or its service agent or a similarly qualified person in order to avoid a hazard.

23. Optional HSPLK Locking Device

The HSPLK locking device can be used to mechanically lock the controls to prevent tampering with settings. As it is not supplied with the heater, kindly contact our Sales team if required.



- Locking tab



- Locking screw



Locking tab

Locking screw

Contact details

Heatstore

Unit 12, Access 18, Bristol, BS11 8HT Telephone: 0117 923 5375

Email: enquiries@heatstore.co.uk <http://www.heatstore.co.uk>