



**THE TOTAL ELECTRIC HEATING SOLUTION**

**HSTIRFX**

**WIRELESS CONTROLLER**



## Installation & Control Guide for **HSTIRFX** Wireless Controller

All electrical appliances produced by the company are guaranteed for one year against faulty materials or workmanship. This applies only if the appliance has been used for purposes in accordance with the instructions provided and has not been connected to an unsuitable electricity supply, or subject to misuse, neglect, damage or modified or repaired by any person not authorised by us. This guarantee is offered to you as an extra benefit and does not affect your legal rights.

The correct electricity supply voltage is shown on the rating label attached to the appliance.

Reasonable care has been taken to ensure that this guide is accurate at the time of printing. In the interests of progress the company reserve the right to vary specifications from time to time without notice.

### **CUSTOMER HELPLINE**

Should you need any advice on the use of your new Heatstore product please contact us via:

#### **Contact details**

Heatstore

Unit 12, Access 18, Bristol, BS11 8HT

Telephone: 0117 923 5375 Email: [enquiries@heatstore.co.uk](mailto:enquiries@heatstore.co.uk)

<http://www.heatstore.co.uk>

# HSTIRFX

## Installation and User Guide

### Warnings

- Do NOT handle the controller with wet hands.
- Do NOT cover the controller.
- Do NOT use the controller if damaged.
- Operating temperature range -10 to +40°C.
- Do NOT use the appliance in workshops or rooms with high dust exposure.
- Do NOT cover or restrict any aperture.
- Ensure that nothing is pushed into any aperture of this controller.

### Safety and Care

The controller is **NOT** intended for use by persons (including children) with reduced physical, sensory or mental capabilities or lack of experience or knowledge unless they have been given instruction concerning use of the appliance by a person responsible for their safety. Children should be supervised to ensure that they do not play with the controller.

### Introduction



The HSTIRFX must be paired to each heater, otherwise the heaters will not work (see next page).



The HSTIRFX Wireless Controller can control any 'RF' heater, including multiple products at the same time.

### Getting to know your HSTIRFX wireless controller

Indication of displayed temperature

Programme number in AUTO mode

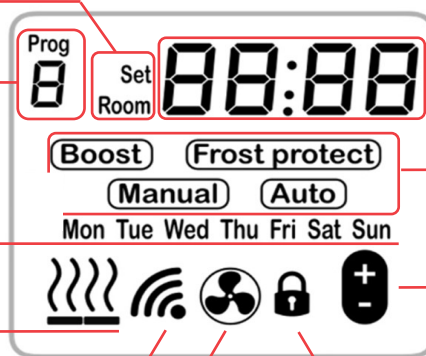

Time or temperature

Operating mode

Day

Adjustment possible symbol

Heating active symbol

Anti - tamper lock

Radio transmit symbol

Fan only operating mode

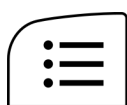

MENU/MODE button

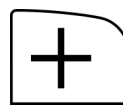

Increase button



STANDBY button

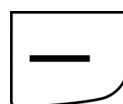

Decrease button

# HSTIRFX

## Installation and User Guide

### Buttons

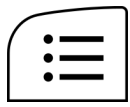

MENU/MODE button

- **Short press** : Cycle through operating modes BOOST, MANUAL, AUTO, FROST, FAN.

- **Long press** : Used for advancing programme, setting the time and accessing programming menu.



STANDBY button

Use this button to activate or deactivate the heating.

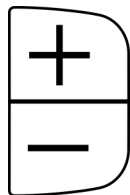

Increase/decrease buttons

Increase/decrease buttons are used to change the set temperature when in normal use or to change value when in setting up the controller.

### Pairing with heaters

**This must be done, otherwise the heaters will not work.**

- Ensure power to the heater is OFF.
- Turn power to the heater ON.
- Within 20 seconds, press and hold the 'MENU/MODE' and '+' buttons on the controller until the display shows 'PAIR'
- The heating will switch on. If the heating is set to off, after 4 seconds the heating will turn off.
- The heating is now ready to be used.

### Installation



**The controller must be wall mounted.**



### Choosing a position in a room

When installing HSTIRFX, a suitable position in the room should be chosen. Ideal installation height is 1.2m - 1.6m. Avoid areas with draught or direct sun. Do not position HSTIRFX above or close to the heaters or other heat sources. Damp areas or areas where HSTIRFX can be mechanically damaged should also be avoided. As the HSTIRFX is measuring room temperature it has to be installed in the same room as heaters.

### Mounting the controller

The HSTIRFX was designed to fit any standard 2 gang back box with a minimum depth of 32mm. Use the supplied screws to secure controller on the back box. **Avoid over-tightening.**

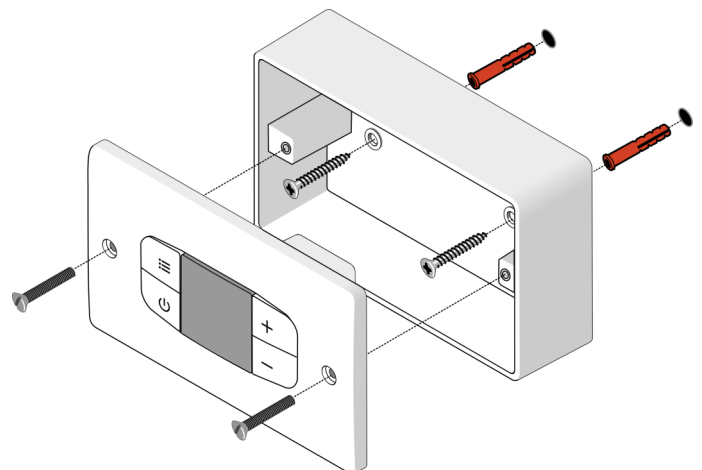

# HSTIRFX

## Installation and User Guide

### Electrical Connections

Electrical installation should be carried out by a competent installer in accordance with the latest edition of the IEE Wiring Regulations, (BS.7671), and any relevant Local Authority Bye-Laws.



**The HSTIRFX must be permanently connected to the electricity supply via a double pole switch having 3mm gap on each pole. There are no exceptions.**

A switched Fused Connection unit to BS.1363. Part 4 is a recommended mains supply connection accessory to ensure compliance with safety requirements applicable to fixed wiring installation.

### Heating Not Working

- Check that the power is available to the HSTIRFX and heater.
- Check the LCD display isn't blank and there is a green light on the heater.
- Is HSTIRFX paired with the heater?
- Check that the overheating protection on the heater has not operated. Follow the instructions given under the section headed 'Overheating protection.'
- Check that the fuse in the fused connection unit has not blown. This fuse can be replaced.
- Should none of the above remedies work, then please telephone the helpline number shown in these instructions. Do not attempt to repair the heating.

### Basic Operation

The HSTIRFX has 5 standard operating modes:

**BOOST, MANUAL, FROST PROTECT, AUTO and FAN.**



Each mode can be selected by short pressing the MENU button to cycle through the options. The cycle sequence will always start with **BOOST** mode followed by **MANUAL, FAN, FROST PROTECTION** and **AUTO**.

The FAN mode is only available if there is no demand for heating. If the HSTIRFX shows heating symbol the FAN mode isn't available. FAN mode only works with compatible heaters.

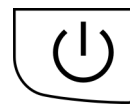

The HSTIRFX also has a **STANDBY MODE**. To enter/exit this mode, press the standby button. In **STANDBY MODE**, the heating will not be activated and the display will show time and day.

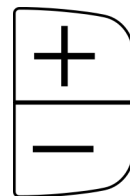

To adjust temperature in any heating mode use 'PLUS' or 'MINUS' buttons.

The HSTIRFX has a battery backup which will keep the correct time and allows for the change of hour associated with British Summer Time. The HSTIRFX will also remember all time schedules and settings even if the power is interrupted.

# HSTIRFX

## Installation and User Guide

### Boost Mode

The boost feature increases the room temperature for 15 minutes. To amend the set temperature when in **BOOST** mode, use the **+** and **-** buttons to change the temperature. Once the temperature is set, you can leave the display to return to the main screen and the settings will be saved. After 15 minutes, the HSTIRFX will return to the previous operating mode.

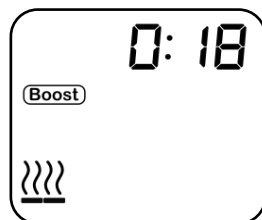

### Manual Temperature Mode

In **MANUAL** mode, the heater maintains a chosen set temperature between 15°C and 35°C. To amend the set temperature when in **MANUAL** mode, use the **+** and **-** buttons. Once the temperature is set, you can leave the display to return to the main screen and the settings will be saved. When the room temperature reaches the set temperature, the heating will be deactivated.



### Frost Protection Mode

In **FROST PROTECT** mode, the heater maintains a chosen set temperature between 4°C and 15°C. To amend the set temperature when in **FROST PROTECT** mode, use the **+** and **-** buttons. Once the temperature is set, you can leave the display to return to the main screen and the settings will be saved.



### Auto Control Mode

In this mode, the heater will follow the week's time / temperature program. The temperature can be temporarily overridden in **AUTO** mode by using the **+** and **-** buttons to set the new temperature. The new set temperature will be then maintained until the next program step.

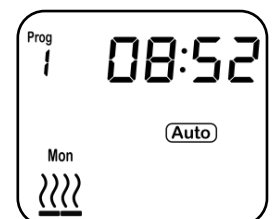

### Fan Mode

The FAN mode is only available if there is no demand for heating. If the HSTIRFX shows heating symbol the FAN mode isn't available. FAN mode only works with compatible heaters.



# HSTIRFX

## Installation and User Guide

### Heat Symbols

Every time there is a demand for heat, the display will show the heat icon. The symbols shown below are used to represent full heat and half heat. The half heat only works with 'RF' heaters. The HSTIRFX will set heating to half heat automatically when the room is almost at the required temperature. This will stop temperature overshooting.

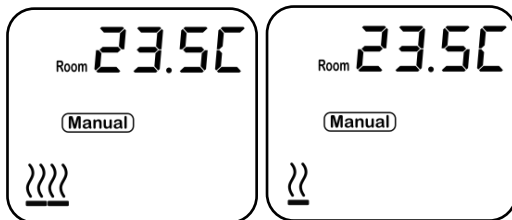

Full heat

Half heat

### Keys Locking

Press and hold the + and - buttons together for 5 seconds. The display will show the  symbol. Repeat the step to unlock.

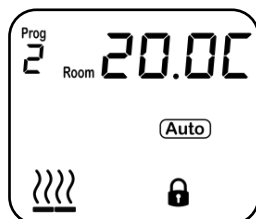

### Open Window Detection

Ensuring you don't waste energy by heating the outside world, the heater is equipped with optional open / closed window detection. The heater recognises sudden drops in temperature when a window or a door is opened and turns the heating off.

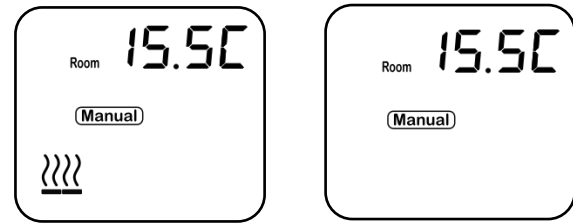

When the window is closed, the heater will automatically detect a temperature rise, and switch itself back on. Once enabled in the setup menu, the open window detection is fully automatic and does not require any human intervention to be activated. When open window detection has been triggered, the heat symbol will flash on/off as shown above. The system has been factory set to default time and temperature values. If necessary, all values can be adjusted. When the heating is on, open window detection sensor will automatically switch the heater off when it detects a fall in temperature of 2°C in less than 10 minutes (the temperature can be changed in menu 8 and time in menu 7). If a temperature rise of 2°C in less than 30 seconds is detected, the heater will switch itself back on (the temperature can be changed in menu A and time in menu 9).

### Setting The Time and Day

The HSTIRFX will come set with the correct time and day. It has an internal battery back up that can remember the settings. It will automatically change the clock to adjust the British summer time. Should you need to alter the time, see the section "set-up menu".

# HSTIRFX

## Installation and User Guide

### Set up Menu

1. Press and hold 'MENU' and '-' together for 5 seconds.
2. The display will enter the setup menu.
3. Use '+' and '-' to change a value.
4. Use MENU to scroll between the settings.
5. Use standby button to exit the setup menu.

#### 1 - Temperature Calibration

The temperature reading is factory calibrated but if for any reason it needs adjusting (better accuracy required, to suit particular position in the room etc.), the reading can be recalibrated in 0.5 degree steps.

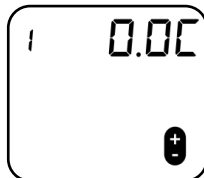

#### 2 - Celsius / Fahrenheit



#### 3 - Adjust fan speed

(Select models only. Does not apply in manual control mode.)

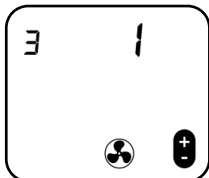

#### 4 - Set minimum temperature

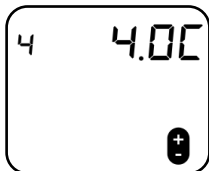

#### 5 - Set maximum temperature



#### 6 - Enable/disable open window detection



#### 7 - Open window detection time (minutes)



#### 8 - Temperature drop in open window detection time



#### 9 - Closed window detection time (minutes)

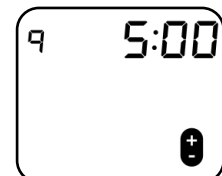

#### A - Temperature rise in closed window detection time

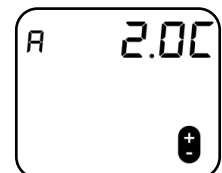

#### B - Program mode select.

Choose between a 7-day, 5-day 2-day or a 24 hour timer.



#### C - Select operating mode:

1 = temperature control  
2 = manual control  
3 = local temperature control (Specific heaters only)

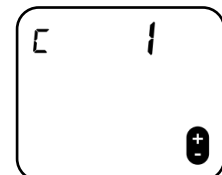

#### D - Time and Date setting.

The year is shown first, use + and - to change, then press menu to change date and time.

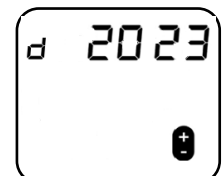

#### E - Backlight Setting

If this is **OFF** the back light will turn off after 15 seconds. The display must be activated before using the controls.



If this is **ON** the back light will be permanently on when the heater is active.

# HSTIRFX

## Installation and User Guide

### Setting the automatic program schedule

An example of a programs on HSTIRFX

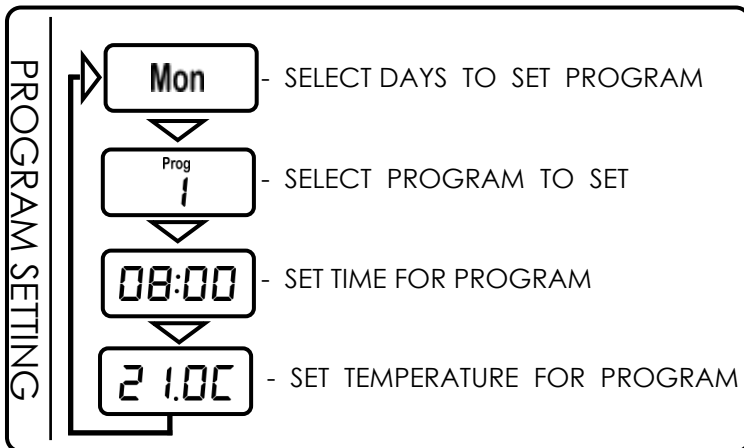
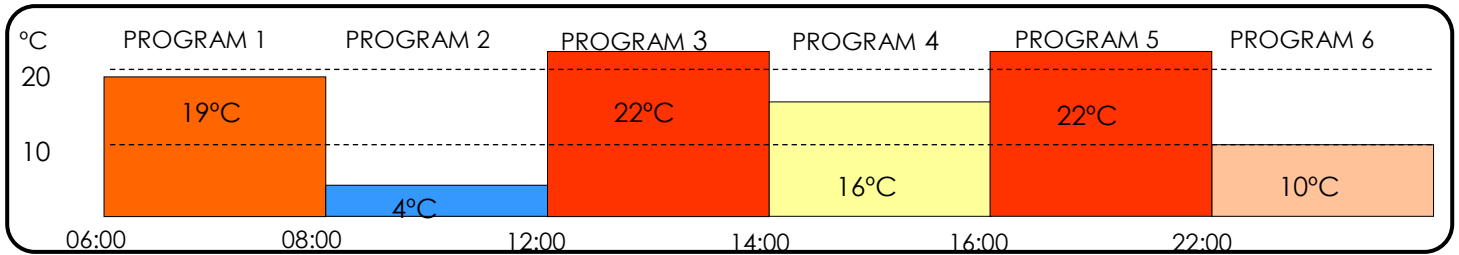

The timer is set to 5 days and 2 days as default. This section provides an example of how to set the program for Monday to Friday. The example will program the timer to maintain 21°C from 08:00 until 16:00. It will maintain 4°C from 16:00 onwards. It does this by setting the programs as follows;

- Prog 1** - Set to 08:00 and 21°C
- Prog 2** - Set to 16:00 and 4°C
- Prog 3, 4, 5, 6** - Set to inactive

The steps to program this are shown below;

**Step 1:** Heater must be ON. Press and hold the MENU button. Monday to Friday should flash.



**Step 2:** Press the MENU button. Prog 1 in the top left of the display should flash. This represents the program number. Each day has 6 programs.



**Step 3:** Press the MENU button. The time should flash. Use the + and - buttons to set the time you want the heating to switch on.



**Step 4:** Press the MENU button. The temperature should flash. Use the + and - buttons to set the temperature you want to maintain.



**Step 5:** Press the MENU button. Monday should flash again.



**Step 6:** Press the MENU button. Prog 1 in the top left of the display should flash. Use the + button to increment this to Prog 2. (Note: you can cycle between the different programs using the + and - buttons)



# HSTIRFX

## Installation and User Guide

**Step 7:** Press the MENU button. The time should flash. Use the + and - buttons to select the time you want the heating to switch off.



**Step 8:** Press the MENU button. The temperature should flash. Use the + and - buttons to select a frost protection temperature.

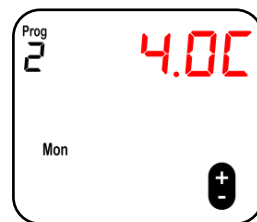

**Step 9:** Repeat these steps for programs 3-6 if additional time periods are required. Any programs not being utilised must be deactivated. To do this, simply select the program in question as per step 6 and press the STANDBY button. The time should change to dashes as shown below. To reactivate the program, simply press the STANDBY button again.

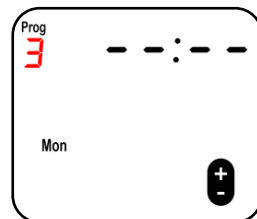
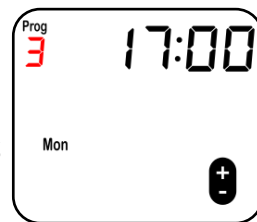

### Overview of Auto Mode

The HSTIRFX has a 7-day, 5-day + 2-day and a 24 hour timer available. These can be chosen in the setup menu. Up to 6 programming steps are available for each day. In the programming you can set a start time and a temperature for each program.

1. Press and hold MENU for 5 seconds to enter the programme settings.
2. The day will be flashing. Use + and - to navigate day, press MENU to select day.
3. PROG 1 will be flashing. Use + and - to navigate program, use MENU to select program.
4. The time will be flashing. To set time, use + and - , press MENU to set the time.
5. The temperature will be flashing. To set temperature, use + and - to change temperature, press MENU to set temperature.

### Setting Programme Inactive

If you do not require the use of all 6 programs they can be deactivated. When in programming mode select the program you want to make inactive and press the STANDBY button. To activate the program again, press the STANDBY button.

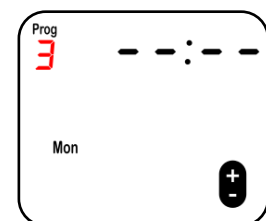

# HSTIRFX

## Installation and User Guide

### Copy Day Function

If you require the same set of programs throughout the week, a 24 hour timer is available. This will use the same program every day. A 5-day + 2-day timer is also available. This will use the same programs Monday - Friday, and separate programs Saturday and Sunday. These modes are enabled in the setup menu, as explained in the "setup menu" section.

When the timer is set in setup menu as 7 day, it is possible to copy a program from one day to another.

To do this, follow the steps below;

**Step 1:** Press and hold MENU for 5 seconds to enter the program setting.



**Step 2:** Press and hold STANDBY for 5 seconds to enter the copy day setting.

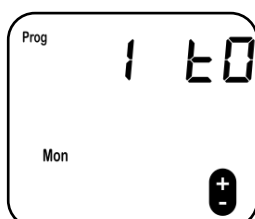

**Step 3:** Use the MENU button to select the day to copy the programs from. 1 = Monday, 2 = Tuesday and so on.

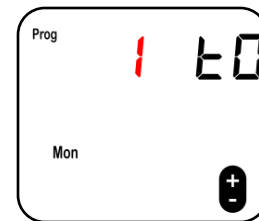

**Step 4:** Use the + and - buttons to select the day to copy the programs to.

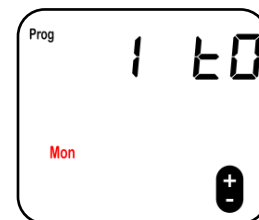

**Step 5:** Press the STANDBY button to copy the programs. The 'TO' will flash to confirm the programs have been copied.

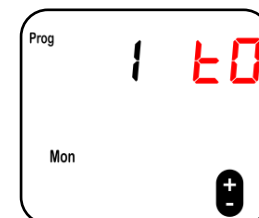

# HSTIRFX

## Installation and User Guide

### Local temperature control mode

Local temperature control mode is only compatible with certain heaters. Unlike normal temperature control mode, the temperature measured on the controller does not affect the heater output. Instead, the HSTIRFX simply sends the target temperature to the heater.

The heater uses this as the set temperature. It uses a local temperature sensor to measure the room temperature at the heater location itself. When the local temperature reaches the set temperature, the heater will switch off.

Refer to section 'set-up menu' for information on how to access local temperature control mode.

### Manual control mode

Manual control mode allows the heat and fan settings to be selected manually regardless of the room temperature.

To operate manual control mode, activate the display and press the MENU/MODE button. The fan speed can now be set using the + and - buttons. Press the MENU/MODE button again. The heat setting can now be set using the + and - buttons.

Manual control mode has 3 fan speeds and 3 heat settings available. Not all products have multiple fan and heat settings. Please refer to the heater's user manual to check how many heat/fan settings it has available.

Refer to section 'set-up menu' for information on how to access manual control mode.



THE TOTAL ELECTRIC HEATING SOLUTION



# Declaration Of Conformity

In accordance with UK Government Guidance.  
WE HEREBY CERTIFY THAT THE APPLIANCES DETAILED HEREON HAVE BEEN  
INSPECTED AND TESTED, AND CONFORM TO THE REQUIREMENTS OF THE  
FOLLOWING UK STATUTORY INSTRUMENTS WHERE APPLICABLE:

- Electrical Equipment (Safety) Regulations 2016 SI. 2016 1101**
- Electromagnetic Compatibility Regulations 2016 SI. 2016 No. 1091**
- Radio Equipment Regulations 2017 SI. 2017 No. 1206**
- The Ecodesign for Energy Related Products and Energy Information (Amendment) (EU Exit) Regulations 2019. SI. 2010 2617**
- The Restriction of use of Certain Hazardous Substances. SI. 2012 No. 3032**
- The Waste Electrical and Electronic Equipment Regulations 2013. SI. 2013 No. 3113**

## Transposed standards used:

- BSEN55014 (2006)**
- BSEN301 489.1 & .3**
- BSEN300 220.1 & .2**
- BSEN60 730.2.9**
- BSEN 60335.1 (2012 )**
- BS EN 60335.2.30 (2009)**

**PART NUMBER** HSTIRFX

**NAME OF RESPONSIBLE PERSON:**  
**POSITION:**  
**DATE:**

**Martyn Field**  
**Technical Manager**  
**01/10/2024**

### Contact details

Heatstore  
Unit 12, Access 18, Bristol, BS11 8HT  
Telephone: 0117 923 5375 Email: enquiries@heatstore.co.uk  
<http://www.heatstore.co.uk>

