

Part number

CSHF 24



Female insert, CSH series, SQUICH® spring terminal connection without tools, 24 poles + PE, 16 A 500 V 6 kV 3, size "104.27"

Product description	
Product type	Insert
Series	CSH
Connection type	SQUICH® spring terminal connection without tools
Gender	Female
N. of poles	24 poles + 
Size	Size "104.27"

Technical data	
Current	16 A
Voltage	500 V
Rated impulse withstand voltage	6 kV
Pollution degree	3
Rated voltage according to UL/CSA	600 V
Wire cross-section	0,14 mm ² - 2,50 mm ²
AWG size	26 - 14
Contact type	Turned silver plated
IP degree of protection	IP20 without enclosure, IP65/IP66/IP68/IP69 with enclosure

Further technical details	
Characteristics according to EN 61984	16 A 500 V 6 kV 3; 16 A 400/690 V 6 kV 2
Mating cycles	≥ 500
Insulation resistance	≥ 10 GΩ
Contact resistance	≤ 3 mΩ
Weight	126,00 g
Operating temperature range (min, max)	-40 °C ... +125 °C
Conductors stripping length	9...11 mm
UL 94 flammability rating	V-0
Torque for main contact	M2,5: 0.4 Nm; 3.5 lb.in (0,5 x 3mm)
Tightening torque for PE connection	M4: 1,2 Nm, 10,6 lb.in (Ph2 or 1,0x5,5mm)
Tightening torque for fixing screws	M3: 0.5 Nm; 4.4 lb.in (Ph1 or 0.8x4 mm)

Material properties	
Main material	Polycarbonate (PC)
Other materials	Contacts: copper alloy
Colour	RAL 7032 grey
RoHs conformity	Compliant with exemption 6(c): copper alloy containing up to 4% lead by weight
China RoHs - EFUP	50
REACH SVHC substances	Yes Lead

Approvals / Standards	
Reference standard	EN 61984:2009-06
Certifications	CSA, CQC, DNV-GL, BV, EAC
UL	ECBT2, PVVA2
cUL	ECBT8, PVVA8

General ordering information	
EAN13 code	8015747019316
ETIM 7.0	EC000438

Packaging Information	
Packaging length	245,00 mm
Packaging height	165,00 mm
Packaging width	215,00 mm
Packaging weight	4,28 kg
Packaging volume	8,69 dm ³
Packaging description	Carton box
Packaging quantity	30 Pcs
Packaging EAN code	8015747170703
Sub-packaging length	197,00 mm
Sub-packaging height	44,00 mm
Sub-packaging width	113,00 mm
Sub-packaging weight	0,71 kg
Sub-packaging volume	0,98 dm ³
Sub-packaging description	Carton tray
Sub-packaging quantity	5 Pcs
Sub-packaging EAN barcode	8015747170710

Part number CSHF 24



Catalogue drawings

Catalogue drawings

dimensions in mm

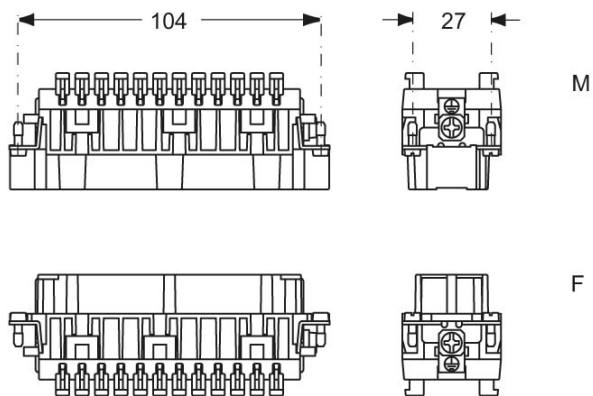

contacts side (front view)

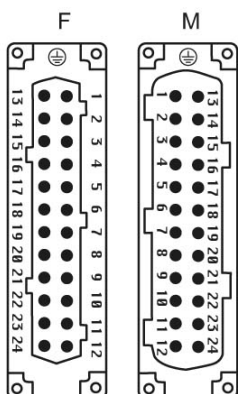
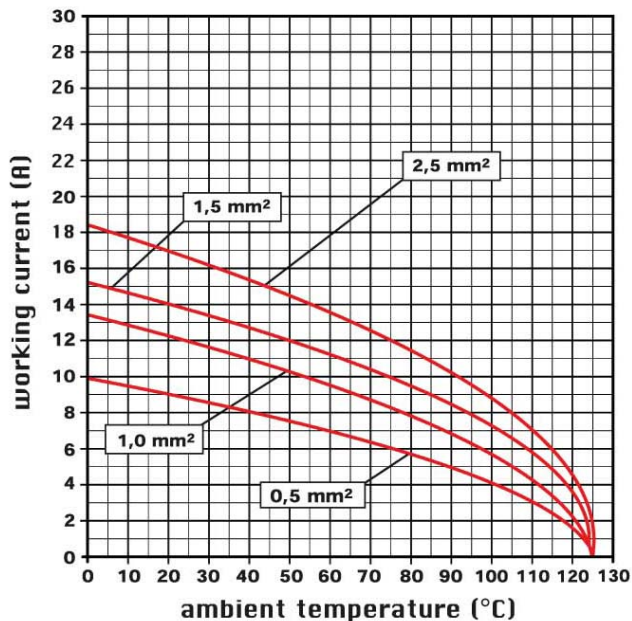

diagram CSH 24 poles



Notes

Dimensions shown in mm are not binding and may be changed without notice.

California Proposition 65 Information



WARNING

This product can expose you to lead and its compounds, known to the State of California to cause cancer and/or reproductive toxicity. For more information go to www.P65Warnings.ca.gov.

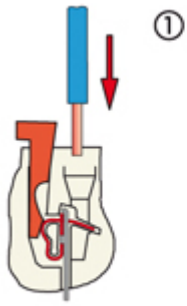

①

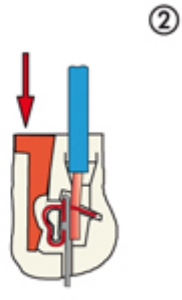

②

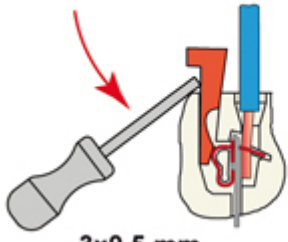

3x0,5 mm

Reopening
