

Part number

MHO 24.25



Brief description:

hoods for two levers, size "104.27", side entry, M25, metal version, IP66



Product description

Version	metal version
Series	hoods for two levers
Product type	with 4 pegs
Variant	side entry
Family	CLASS enclosures
Size	size "104.27"

Technical data

Material	metal
IP degree of protection	IP66 (and IP69K DIN 40050 - 9)
Cable entry	M25

Further technical details

Weight	180,00 g
---------------	----------

Approvals / Standards

Quality mark	 (type:4/4X/12),  , EAC
Conformity	CQC, CE

General ordering information

EAN13 code	8015747053570
Tariff number	85369095

Packaging Information

Packaging length	250,00 mm
Packaging height	145,00 mm
Packaging width	300,00 mm
Packaging weight	4,15 kg
Packaging volume	10,88 dm ³
Packaging description	Carton box
Packaging quantity	20 Pcs
Packaging EAN code	8015747053587
Sub-packaging weight	1,04 kg
Sub-packaging description	Plastic packaging
Sub-packaging quantity	5 Pcs
Sub-packaging EAN barcode	8015747053594

Part number

MHO 24.25



Catalogue drawings

**CHO [CAO] CHV (CAV) - MHO [MAO]
MHV (MAV)**

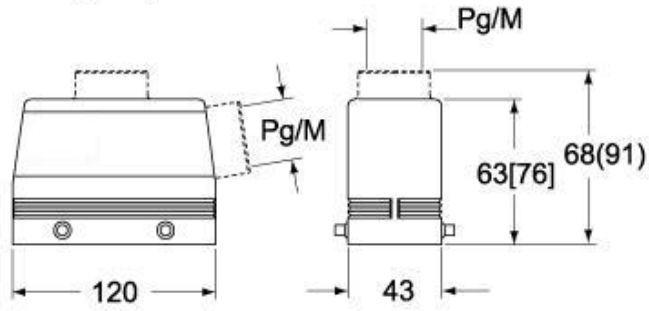

CHV G (CAV G) - MHV G (MAV G) - [MFV G]

