

# Miniature Circuit Breakers B4/BR6/B10



Technical Datasheet

The IMO range of miniature circuit breakers have been designed for protection of electrical installations against overload and short circuits and are manufactured in accordance with IEC 60898-1

## Technical Data

- Handle central-tripping function for circuit fault indicating
- New front design; cover and handle in arc shape
- Contact position indicating window; transparent cover to carry label
- High short circuit capacity
- Suitable for terminal and Pin/Fork type busbar connection
- Finger protected connection terminals
- Handle padlock device



Tripping characteristics in accordance with B, C and D type curves

- Curve B: 3-5  $I_n$  Certification: B4: Semko / CE
- Curve C: 5-10  $I_n$  B10: VDE / Semko / CE
- Curve D: 10-20  $I_n$

## Options & Ordering Codes

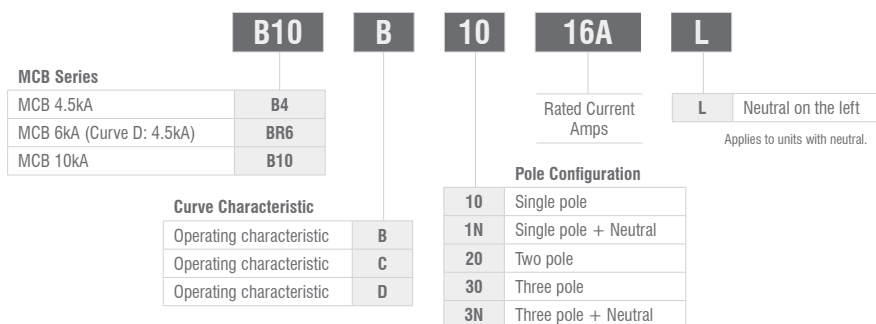

## Specifications

In accordance with	IEC 60898-1	
Certification	CE, SEMKO (only with B4 & BR6), Kema (only with B10), RCM (only with B4 & B10)	
Pole composition	1P, 1P+N, 2P, 3P, 3P+N	
Tripping Curve	B, C, D	
Calibration temperature	+30°C	
Rated frequency	50/60Hz	
Rated voltage	240/415VAC; 60VDC Max	
Rated insulation voltage	240VAC / 415VAC	
Rated impulse withstand voltage:	6.2kV	
Rated short circuit breaking capacity as per IEC 60898-1 and IEC60947-2	B4	4.5kA
	BR6	4.5kA (Curve D only), 6kA
	B10	10kA
Mechanical lifetime	> 20,000 cycles	
Electrical lifetime	≤ 4,000 cycles	
Tightening torque	2.0Nm, 1.2Nm (B4 only)	
Screw Type	M5, M4 (B4 only)	
Terminal capacity	35mm <sup>2</sup> solid, 25mm <sup>2</sup> stranded conductor (10mm <sup>2</sup> for 1P+N)	
Mounting	DIN Rail EN 60715 (EN 50022)	
Protection degree	IP20	
Operating temperature	-5°C +40°C	

# Miniature Circuit Breakers B4/BR6/B10



## Technical Datasheet

### Accessories

<b>Auxiliary Switch</b>	<b>B10-F3 (for B10 MCB, B10R RCD &amp; B6 RCBO)</b>
For monitoring the status of the protection device (open/closed)	
1 pole changeover (for C & D curve only)	
Rated current: 6A @ 230VAC & 24VDC or 3A @ 400VAC	
Dielectric Strength: 2000V/1min	
Terminal Capacity: 2.5mm <sup>2</sup>	
Mounting on the Left side	

<b>Shunt Trip</b>	<b>BR6-S2 (for BR6) &amp; B10-S3 (for B10)</b>
Shunt Trip to remotely switch off the protection device	
Rating voltage Ue: AC 110V / 230V / 400V	
Operating Voltage: 70%~110% X Ue	
Mounting on the Left side	

<b>Under / Over Voltage Trip</b>	<b>BR6-U2-02</b>
Trips the attached unit in case of under / over voltage	
Rated Voltage Ue: AC 230V	
Over-Voltage Tripping Range: 280V ±5%	
Under-Voltage Tripping Range: 170V ±5%	
Mounting on Left Side	

Busbars	
Description	Ref.
Busbar 1 Pole, 80A, Fork Type, 1M	B10BB1F100-1M
Busbar 3 Pole, 80A, Fork Type, 1M	B10BB3F100-1M
Busbar 1 Pole, 80A, Pin Type, 1M	B10BB1P100-1M
Busbar 3 Pole, 80A, Pin Type, 1M	B10BB3P100-1M
End Cap 3 Pole (Fork type only)	B10BBCAP3F100

<b>Terminal Adapter</b>	<b>BA1</b>
-------------------------	------------

<b>Locking Device</b>	<b>B10-LOCK</b>
4mm padlock max diameter, padlock not included	

<b>Blanking Cap</b>	<b>B10-TERM</b>
---------------------	-----------------

### Dimensions (mm)

#### Miniature Circuit Breakers up to 32A (4.5kA Only)

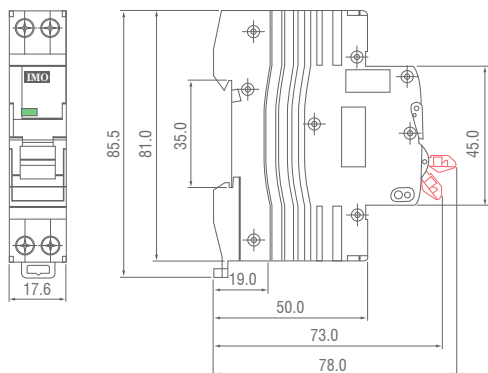

#### Miniature Circuit Breakers up to 63A

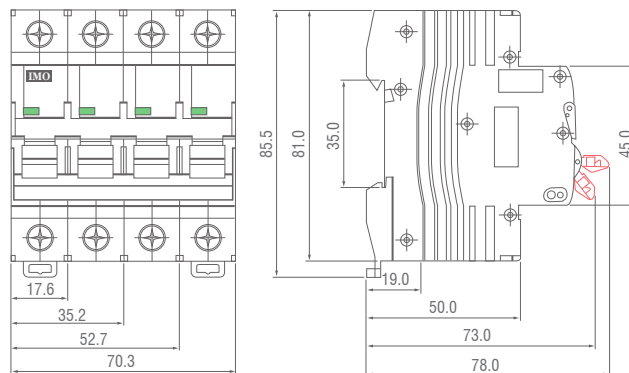

#### Miniature Circuit Breakers from 80A to 125A

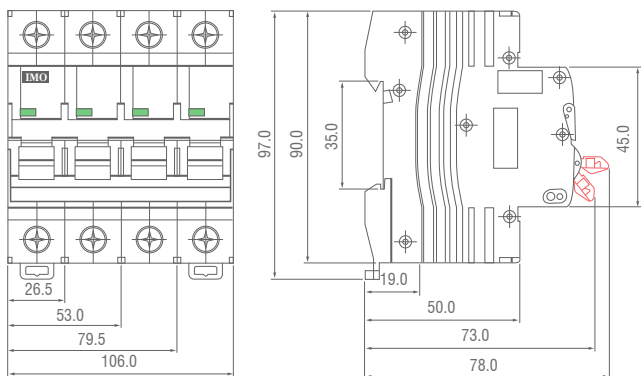

#### MCB - BR6-U2/02 Wiring Diagram



# Miniature Circuit Breakers B4/BR6/B10

## Selection Chart

Contact IMO
  4.5kA
  6kA
  10kA

Type	B						C						D					
	1	1+N	2	3	3+N	4	1	1+N	2	3	3+N	4	1	1+N	2	3	3+N	4
Poles	1	1+N	2	3	3+N	4	1	1+N	2	3	3+N	4	1	1+N	2	3	3+N	4
AMPS	1	1	1	1	1	1	1	1	1	1	1	1	1	1	1	1	1	1
	2	2	2	2	2	2	2	2	2	2	2	2	2	2	2	2	2	2
	4	4	4	4	4	4	4	4	4	4	4	4	4	4	4	4	4	4
	6	6	6	6	6	6	6	6	6	6	6	6	6	6	6	6	6	6
	10	10	10	10	10	10	10	10	10	10	10	10	10	10	10	10	10	10
	16	16	16	16	16	16	16	16	16	16	16	16	16	16	16	16	16	16
	20	20	20	20	20	20	20	20	20	20	20	20	20	20	20	20	20	20
	25	25	25	25	25	25	25	25	25	25	25	25	25	25	25	25	25	25
	32	32	32	32	32	32	32	32	32	32	32	32	32	32	32	32	32	32
	40	40	40	40	40	40	40	40	40	40	40	40	40	40	40	40	40	40
	50	50	50	50	50	50	50	50	50	50	50	50	50	50	50	50	50	50
	63	63	63	63	63	63	63	63	63	63	63	63	63	63	63	63	63	63
	80	80	80	80	80	80	80	80	80	80	80	80	80	80	80	80	80	80
	100	100	100	100	100	100	100	100	100	100	100	100	100	100	100	100	100	100
	125	125	125	125	125	125	125	125	125	125	125	125	125	125	125	125	125	125
Weight (g/pc)	100	200	200	300	400	400	100	200	200	300	400	400	100	200	200	300	400	400
Packing (Qty)	12	6	6	4	3	3	12	6	6	4	3	3	12	6	6	4	3	3

Single Module Unit

## B, C, D Tripping Curve

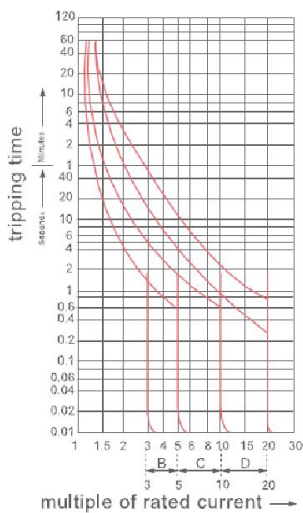

## Power Loss (W)

BR6 Models

	Number of Poles			
	1P	2P	3P	4P
1A	0.70	1.40	2.11	2.79
2A	1.25	2.63	3.90	4.82
4A	1.29	2.53	4.08	5.08
6A	0.92	1.84	2.70	3.84
10A	1.32	2.85	4.24	5.77
16A	2.23	4.62	7.03	9.05
20A	2.67	5.97	8.10	11.35
25A	2.9	5.71	10.27	12.27
32A	3.55	8.30	14.31	17.45
40A	5.39	12.07	18.31	25.2
50A	6.71	14.43	24.09	30.64
63A	7.51	12.88	24.54	33.21

B10B/C/D Models

	Number of Poles			
	1P	2P	3P	4P
1A	1.35	2.70	4.04	5.39
2A	1.71	3.42	5.12	6.83
3A	1.28	2.57	3.85	5.14
4A	1.48	2.96	4.44	5.93
6A	1.67	3.34	5.01	6.68
10A	1.33	2.66	3.99	5.32
16A	2.04	4.09	6.13	8.17
20A	2.16	4.32	6.48	8.64
25A	2.34	4.69	7.03	9.38
32A	3.25	6.49	9.74	12.98
40A	3.22	6.43	9.65	12.86
50A	3.35	6.70	10.05	13.40
63A	4.68	9.37	14.05	18.73

## Ambient temperature & Current rating curve

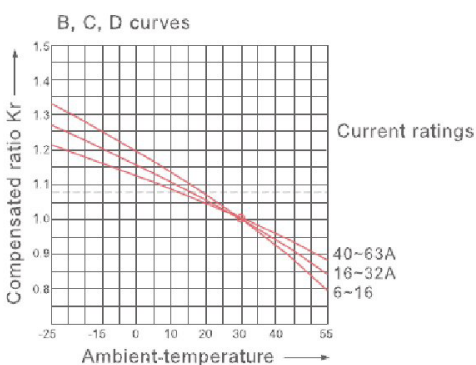

NOTE: These figures should be used for guidance only, and actual value will vary from device to device.



# Residual Current Circuit Breakers With Overload Protection



The IMO range of Residual Current-Circuit Breakers with Overload have been designed for protection of electrical installations against earth fault / leakage current, overload and short circuit and are manufactured in accordance with IEC 61009.

## RCBO Features

- Provides protection against earth fault / leakage current, overload, short circuit and function of isolation
- Elegant appearance; cover and handle in arc shape.
- Contact position indicating window; transparent cover to carry label
- High short circuit current withstand capacity
- Applicable to terminal and Pin/Fork type busbar connection
- Finger protected connection terminals
- Compatible with MCB accessories range
- Handle padlock device



Tripping characteristics in accordance with B, C and D type curves

- Curve B:  $3-5 I_n$
- Curve C:  $5-10 I_n$
- Curve D:  $10-20 I_n$

## Options & Ordering Codes

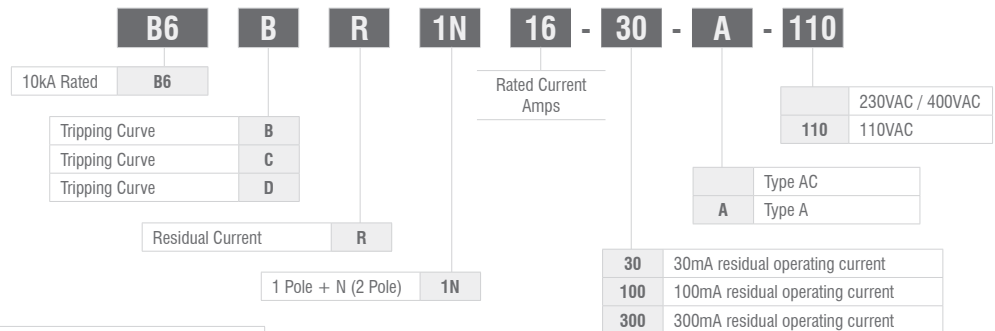

## Specifications

In accordance with:	IEC 61009
Certification:	CE, SEMKO, RCM
Pole composition:	2P
Residual current characteristics:	AC, A
Tripping Curve:	B, C, D
Calibration temperature:	+30°C
Rated current :	1A, 2A, 3A, 4A, 6A, 10A, 16A, 20A, 25A, 32A, 40A
Rated short circuit capacity :	10kA
Rated frequency:	50/60Hz
Rated voltage:	110VAC, 230VAC
Rated residual operating current $I_{\Delta n}$ :	30mA, 100mA, 300mA
Residual tripping current range:	$0.5 I_{\Delta n} \sim 1 I_{\Delta n}$
Electrical lifetime	> 4,000 cycles
Fastening torque:	2.0Nm
Terminal capacity:	35mm <sup>2</sup> solid, 25mm <sup>2</sup> stranded conductor
Mounting on	DIN rail EN 60715 (EN 50022)
Protection degree:	IP20
Operating temperature range:	-25°C - +55°C

## Dimensions (mm)

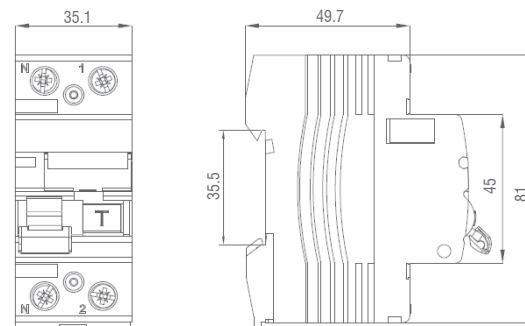

For Dimensions refer to RCCB Data.  
For Tripping Curve refer to MCB.

## Tripping Curve B

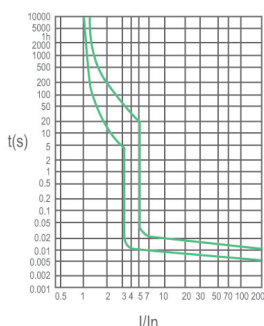

## Tripping Curve C

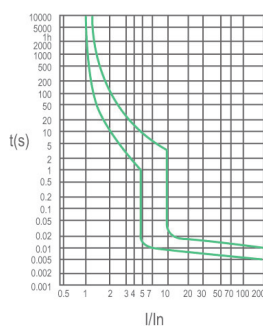

## Tripping Curve D

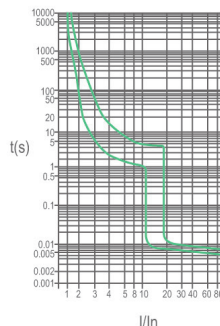

## Wiring Diagram

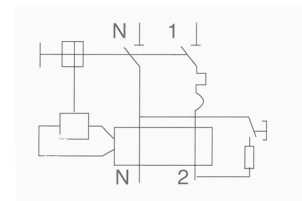

NOTE: For accessories, please see B10 MCB Data

# BIS Isolating Switches

The IMO range of isolating switch have been designed to isolate safely your electrical circuit from the main supply and are manufactured in accordance with IEC 60947-3.

- Capable of switch electric circuit with load
- Elegant appearance; cover and handle in arc shape
- Contact position indicating window; transparent cover to carry label
- Applicable to terminal and Pin/Fork type busbar connection
- Finger protected connection terminals
- Compatible with MCB accessories range
- Handle padlock device



Technical Datasheet



## Options & Ordering Codes

<b>BIS</b>		<b>2</b>		<b>063A</b>	
Distribution board Isolating Switch		<b>BIS</b>			
1 Pole	<b>1</b>	<b>N32A</b>	Compact Size, Blue Handle, 32A		
2 Pole	<b>2</b>	<b>063A</b>	63 Amps		
3 Pole	<b>3</b>	<b>100C</b>	100 Amps		
4 Pole	<b>4</b>	<b>125A</b>	125 Amps		
		<b>250A</b>	250 Amps		

## Specifications

In accordance with	IEC 60947-3
Certification	CE, SEMKO (63 and 125A only)
Pole composition	1P / 2P / 3P / 4P
Rated current	32A / 63A / 100A / 125A / 250A
Rated voltage	AC 230 / 400V
Rated frequency	50/60Hz
Rated short circuit capacity	6kA (3kA for 100A version)
Electrical lifetime	> 10,000 cycles
Fastening torque	2.0Nm
Terminal capacity	35mm <sup>2</sup> solid, 25mm <sup>2</sup> stranded conductor
Protection degree	IP20

## Dimensions (mm) for Compact 32A version

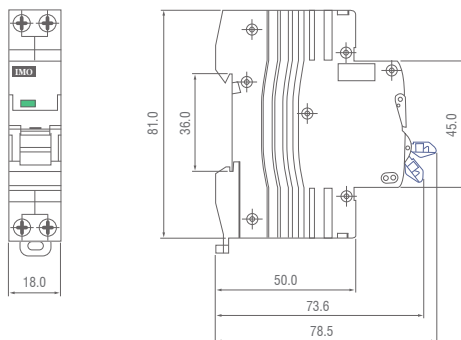

## Dimensions (mm) for 100A version

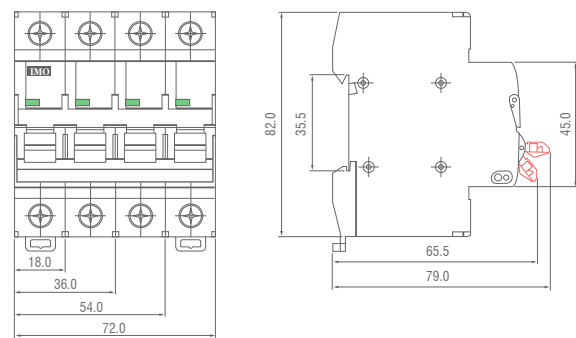

## Dimensions (mm) for 63A & 125A version

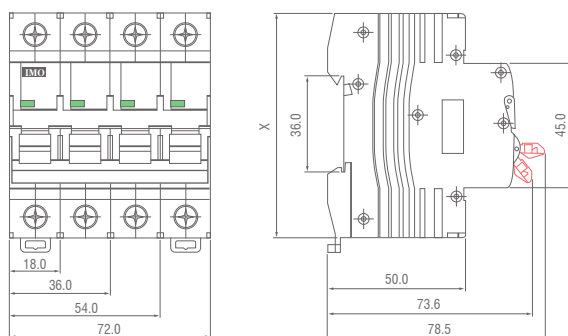

Rating	X
63A	81mm
125A	90mm

## Dimensions (mm) for 250A version

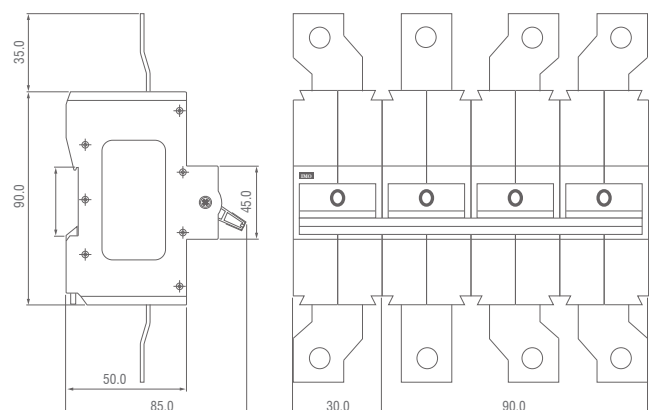

# Residual Current Circuit Breakers With Overload Protection 1P+N Single Module

The IMO range of Residual Current-Circuit Breakers with Overload have been designed for protection of electrical installations against earth fault / leakage current, overload and short circuit and are manufactured in accordance with IEC 61009-1.

## RCBO Features

- Provides protection against earth fault / leakage current, overload, short circuit and function of isolation
- Elegant appearance; cover and handle in arc shape.
- Single width module RCBO, 119mm tall
- Contact position indicating window; transparent cover to carry label
- High short circuit current withstand capacity
- Applicable to terminal and Pin/Fork type busbar connection (line input only)
- Finger protected connection terminals
- Compatible with MCB accessories range
- Handle padlock device



Tripping characteristics in accordance with B, C and D type curves

- Curve B:  $3-5 I_n$
- Curve C:  $5-10 I_n$
- Curve D:  $10-20 I_n$

## Options & Ordering Codes

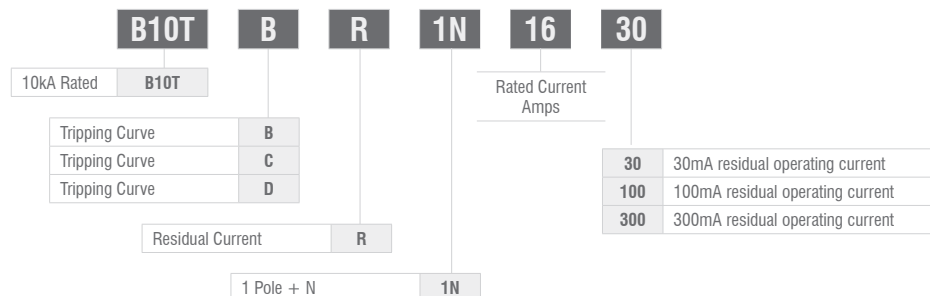

## Specifications

In accordance with	IEC 61009-1
Certification	CE
Pole composition	3P+N
Residual current characteristics	AC
Tripping Curve	B, C, D
Rated current	1A, 2A, 3A, 4A, 6A, 10A, 16A, 20A, 25A, 32A
Rated short circuit capacity	10 kA
Calibration Temperature	+30°C
Rated frequency	50/60Hz
Rated voltage	230/400VAC
Rated residual operating current $I_{\Delta n}$	30mA, 100mA, 300mA
Residual tripping current range	$0.5 I_{\Delta n} \sim 1 I_{\Delta n}$
Electrical lifetime	> 4,000 cycles
Fastening torque	2.0 Nm
Terminal capacity (Live input)	35mm <sup>2</sup> solid or 25mm <sup>2</sup> stranded
Terminal capacity (output)	10mm <sup>2</sup> solid or 6mm <sup>2</sup> stranded
Mounting on	DIN rail EN 60715 (EN 50022)
Protection degree	IP20
Operating temperature	-25°C - +55°C
Weight g/pc	178.0

Dimensions (mm) for 1P+N: 1 module (18W x 119H x 69D)  
For Tripping Curve refer to MCB.

## Wiring Diagram

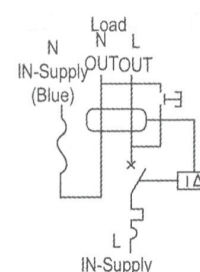

# Residual Current Circuit Breakers With Overload Protection 3P+N

The IMO range of Residual Current-Circuit Breakers with Overload have been designed for protection of electrical installations against earth fault / leakage current, overload and short circuit and are manufactured in accordance with IEC 61009-1.

## RCBO Features

- Provides protection against earth fault / leakage current, overload, short circuit and function of isolation
- Elegant appearance; cover and handle in arc shape.
- 3P+N version, 5 module width RCBO, 119mm tall
- Contact position indicating window; transparent cover to carry label
- High short circuit current withstand capacity
- Applicable to terminal and Pin/Fork type busbar connection
- Finger protected connection terminals
- Compatible with MCB accessories range
- Handle padlock device

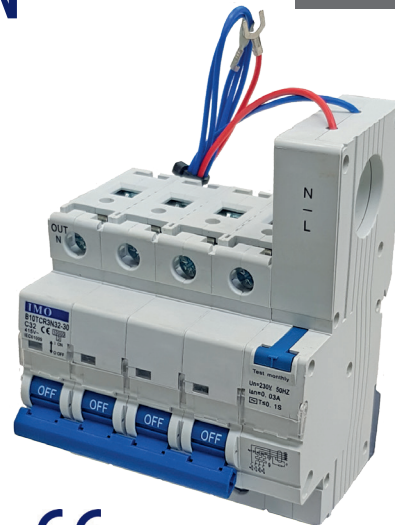

Tripping characteristics in accordance with B, C and D type curves

- Curve B: 3-5  $I_n$
- Curve C: 5-10  $I_n$
- Curve D: 10-20  $I_n$

## Options & Ordering Codes

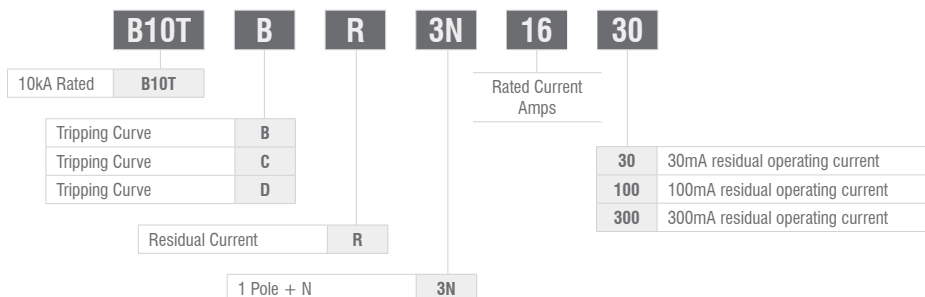

## Specifications

In accordance with	IEC 61009-1
Certification	CE
Pole composition	3P+N
Residual current characteristics	AC
Tripping Curve	B, C, D
Rated current	1A, 2A, 3A, 4A, 6A, 10A, 16A, 20A, 25A, 32A, 40A, 50A, 63A
Rated short circuit capacity	10 kA
Calibration Temperature	+30°C
Rated frequency	50/60Hz
Rated voltage	230/400VAC
Rated residual operating current $I_{\Delta n}$	30mA, 100mA, 300mA
Residual tripping current range	0.5 $I_{\Delta n}$ ~ 1 $I_{\Delta n}$
Electrical lifetime	> 4,000 cycles
Fastening torque	2.0 Nm
Terminal capacity	35mm <sup>2</sup> solid or 25mm <sup>2</sup> stranded
Mounting on	DIN rail EN 60715 (EN 50022)
Protection degree	IP20
Operating temperature	-25°C - +55°C

## Wiring Diagram

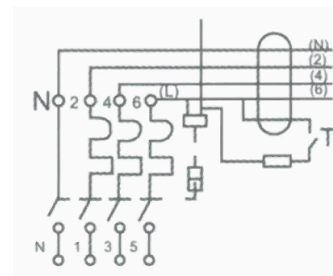

Dimensions (mm) for 3P+N: 4 module (72W x 81H x 69D) + 1 module (18W x 130H x 69D).  
For Tripping Curve refer to MCB.