

JC050002

Toughflood Asymmetric

Toughflood Asymmetric 100W 130lpcW 4000K IP65 Grey

Features & Benefits

- Asymmetric beam angle
- 80° x 150° beam angle which tilts downward at 60°
- IK08 impact rating
- Up to 120 LpcW
- 5 year warranty



General Information

Mounting	Surface Mounted
Trade Name	Toughflood
Environment	Outdoor
Product Group	Floodlight
Color Finish	Gray
Product Shape	Rectangular
Product Range	Exterior
IK Rating	IK08
Overall Dimensions	260 x 277 x 296 x 88mm
Width (mm)	296
Height (mm)	277
Depth (mm)	88
Product Weight(kg)	3
Light Source	LED
Light Source Features	Cool White
Recommended product location	Exterior, general security lighting
Method of fix	Mounting Bracket
IP Rating	IP65

Origin of manufacturer	Made in China
Warranty	5 Year Warranty (See Website for terms and conditions)
Driver manufacturer	Sosen
LED manufacturer/type	Jufei/3030
Lighting Product Type 1	Wall Light
Customs Tariff code**	9405421000

Electrical

Voltage Rating	220-240
Primary Running Current(Amp)	0.7
Inrush current(Amps)	70A/ms @ peak
Operating Frequency Hz	50/60Hz
Secondary running current(mA)	1780-3200
Constant Current or Constant Voltage	CC
Luminaire Circuit Wattage1	100
Class	I
Output Voltage Max/Range (VDC)	32-56
Total Harmonic Distortion (THD)%	10
EMC Compliant (EN55015)	Yes
Power Factor Correction	0.9
Input Electrical Connections	Live(L) Earth(E) Neutral(N)
Dimmable	No

Thermals

Thermal Cut Out	yes
Operating Temperature Range °C	-40 to +60

Performance Data

LED Life (Hours)*	36000
Energy Rating	This product contains a light source of energy efficiency class E
Actual Lumen Output1	11400
Lumens Per Circuit Watt1	114
Color Rendering Index	50-79
CRI: Ra	70
Correlated Colour Temperature1	4000K
Beam Angle °	Wide Flood
LOR (Light Output Ratio) %	100
Photometry Available	Yes

Construction

Primary Material	Aluminium
Outer Diffuser	Toughened glass
Lens	Polycarbonate

Heat Sink
Seal Material

Aluminium
Silicon

Packaging

Product Packaged Weight(kg) **3.7**
Quantity Per Outer Carton **4**
Product Bar Code EAN-13 Number **5052544093555**

Standards & Approvals

Manufactured in accordance to **BS EN 60598-2015,2-1,2-5**
CE Marked **Yes**
UKCA Marked **Yes**
Date code/Purchase order No. **Yes**
WEEE symbol **Yes**
Certificate Of Conformity **Available on request**
Accredited Members **LIA, ISO9001-2015, ISO14001-2015**

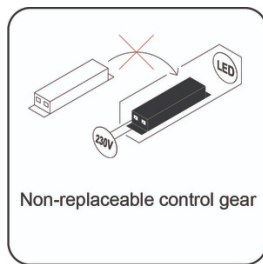
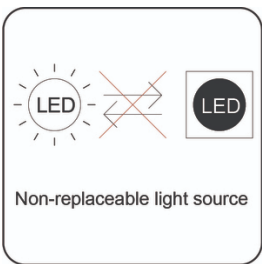
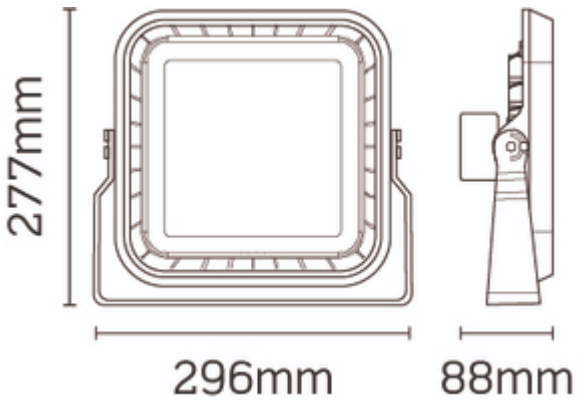

*Hours life stated is an indication of expected L70 chip and light output calculations when operating in optimum conditions. Product warranty period supports the full product during the term given. The L70 hours expectancy is not correlated with the full product warranty term, nor is it a representation of lumen depreciation during the warranty period.

**JCC Lighting Limited makes every effort to ensure that the Customs Tariff information in this document is timely and accurate. However, it's not possible for us to assure the absolute veracity and completeness of that information, as errors may occur. The placement of any inaccurate tariff information is completely unintentional. JCC Lighting Limited reserves the right, in its sole discretion, to correct any errors or omissions to the tariff code and to make any and all changes contained in this document at any time and without notice. It is the sole responsibility of the importer to ensure that the commodity code advised is correct for the products/goods being supplied by JCC Lighting Limited. JCC Lighting Limited does not assume any liabilities, losses, costs, and expenses arising out of or related to the importers use of this commodity code or the information related to the import of any JCC Lighting products.

