

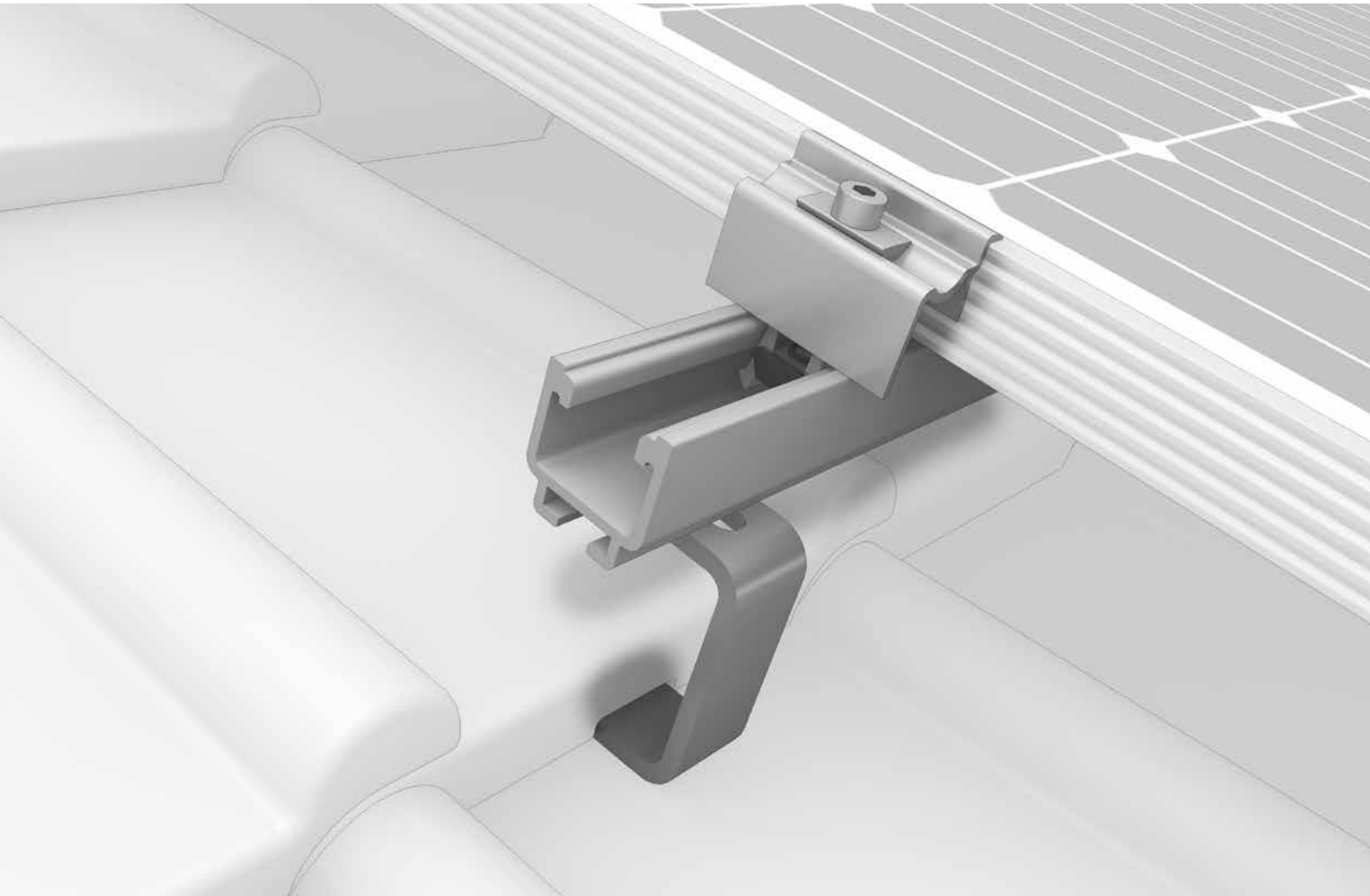

SolidRail System



/ Comprehensive range of mounting rails for varying load profiles

/ Robust and structurally proven

/ High flexibility for a diverse range of widths



Roof fastenings

Stainless steel roof hooks

- / High-quality, thin stainless steel brackets with flexible adjustable connection even for narrow rafters
- / For pantiles, flat tiles and roof tiles
- / Height adjustable and many precisely fitting roof hooks

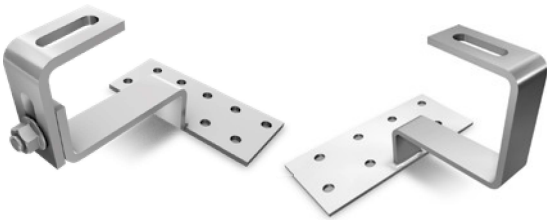

Special roof hooks

- / Many application possibilities with the roof hooks for slate and beaver tail
- / Fastening on Coppo roofs is possible with the 1-fold height-adjustable SolidHook Coppo

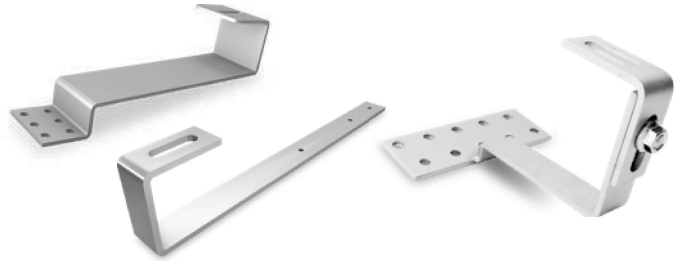

Hanger bolts and solar fasteners

- / For all corrugated fiber cement, corrugated sheet metal and trapezoidal sheet metal coverings as well as sandwich panels
- / Secure sealing at the roofing
- / Connection via adapter plate with adjustment option
- / Hanger bolts with german building authority approval (abZ)







Sheet metal folding clamps

- / Many application possibilities: Standing seam, angle seam, snap seam and round seam [e. g. Kalzip]
- / Rib-Roof solutions for 465, Speed 500 and Evolution
- / Penetration-free mounting



Technical data

SolidRail	UltraLight 32	Light 37	Medium 42	Alpin 60
Figure				
Material	Aluminium [EN AW-6063 T66]			
W = width [mm]	39	39,5	41	41
H = height [mm]	32	37	42	60
Lengths [m]	2.10 / 2.25 / 3.30 / 4.40 / 5.50		4.40	5.50
Weight [kg/m]	0.7	0.85	1.3	1.7
Second rail layer	SingleRail or SolidRail			

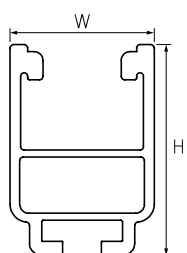

SolidRail L: For heavy loads across large widths!