

**CM350704**  
EZP544MBE

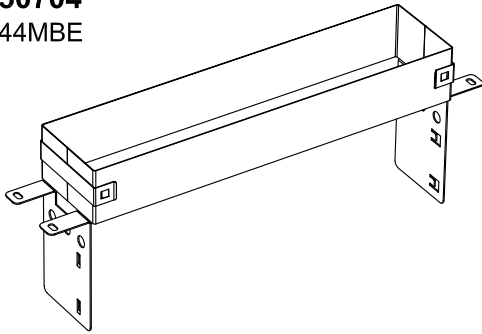

Please refer to CM350704 Application Sheet and Installation Sheet

**CM250058**  
EZD44T  
2 to 5x

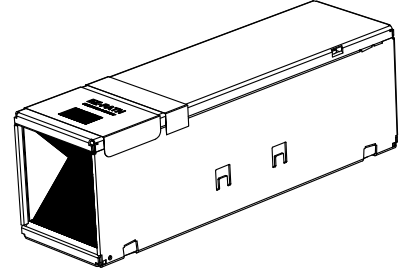

To be ordered separately

**CM350704 + CM250058**  
EZP544MBE + EZD44T

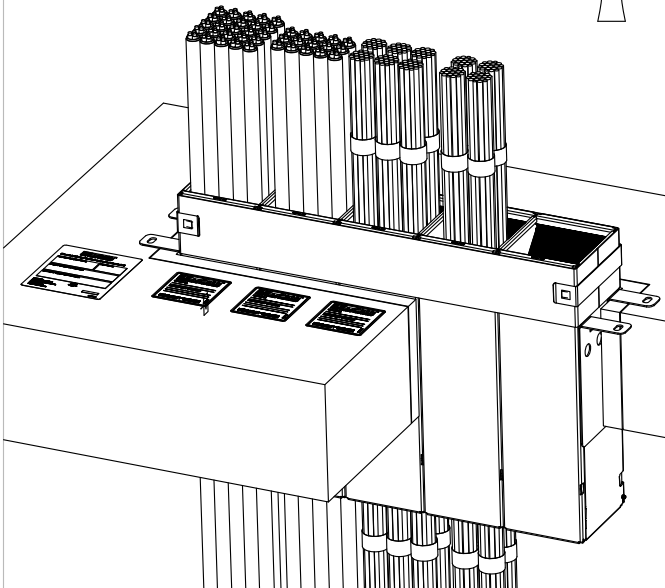
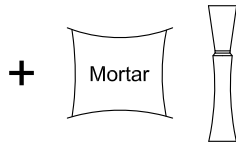

**Ordering information**



CM350704



0.80



1

**Applications**

For all types of cables up to Ø21mm OD  
Rigid floors

**Performance**

Fire resistance : EN1366-3  
Classification : EN13501-2

**Firestop handling**

No handling required for the fire safety compliance

**Dimensions**

Bracket width : 57 mm

**Opening dimensions**

542 x 144 mm  
(+/- 8mm)

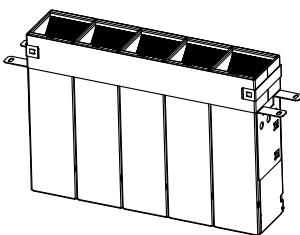

440 x 144 mm  
(+/- 8mm)

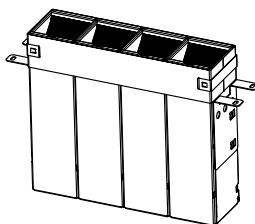

330 x 144 mm  
(+/- 8mm)

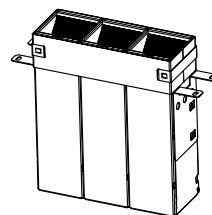

216 x 144 mm  
(+/- 8mm)

