

Product Data Sheet

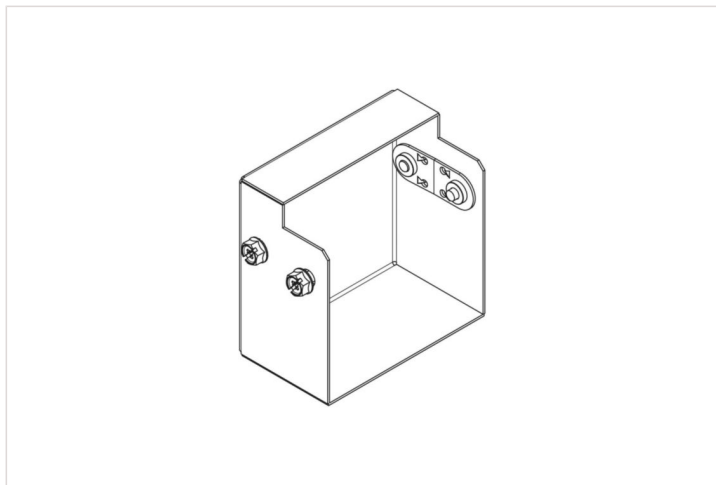

SALAMANDRE LEGRAND

Salamandre IP4X Pre-Galvanised Steel Distribution Trunking End Cap 50mm x 50mm

REF. MGIP22E | EAN. 5012774583493

> [Link to e-catalog product sheet](#)

Technical characteristics

Width	50 mm
Height	50 mm
Connector	Integrated connector
Material	Steel
Material quality	Other
Surface protection	Continuously galvanized
Tamperproof	No

Suitable for use in an IP30 system	Yes
Suitable for use in an IPXXD system	No
Suitable for use in an IP4X system	Yes
Suitable for use in an IP54 system	No
Suitable for use in an IP55 system	No
Suitable for distribution trunking system	Yes
Suitable for lighting trunking system	No

Documents

Catalogue pages

salamandre-distribution-trunking-2019-015.pdf | PDF (0.58Mo)

salamandre-distribution-trunking-2019-008-009.pdf | PDF (1.53Mo)