

Product Data Sheet

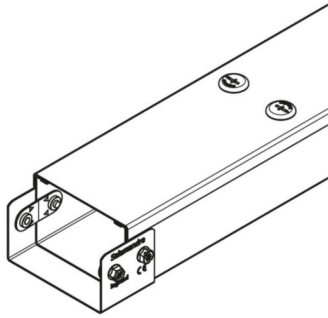

SALAMANDRE LEGRAND

Salamandre 1 Compartment Pre-Galvanised Steel Distribution Trunking 50mm x 50mm x 3m Length

REF. MGR22 | EAN. 5012774581482

> [Link to e-catalog product sheet](#)

Product description

- A safety return edge steel surface trunking system with strength and rigidity
- Manufactured to BS EN 50085-2-1
- Supplied with coupler (fitted), lid and lid fixings
- Supplied as standard with push-fit diecast turnbuckle fixings

Technical characteristics

Width	50 mm
Height	50 mm
Length	3000 mm
Number of compartments	1
Connector	Integrated connector
Material	Steel
Material quality	Other
Surface protection	Continuously galvanized
With cover	Yes

Mounting method cover	Spagnolet
Tamperproof	No
Suitable for use in an IP30 system	Yes
Suitable for use in an IP4X system	Yes
Suitable for use in an IP54 system	No
Suitable for use in an IP55 system	No
Suitable for use in an IPXXD system	No
Suitable for distribution trunking system	Yes
Suitable for lighting trunking system	No

Documents

Catalogue pages

[salamandre-distribution-trunking-2019-011.pdf](#) | PDF (0.28Mo)

[salamandre-distribution-trunking-2019-008-009.pdf](#) | PDF (1.53Mo)

Agreements & certificates

[LGRP-00994-V01.01-EN.pdf](#) | PDF (0.65Mo)