

10A 1P+N Arc Fault Detection Device Bidirectional 1 Module 6kA C Curve Type A 30mA

Product Ref: **10A2P30CAFDD**

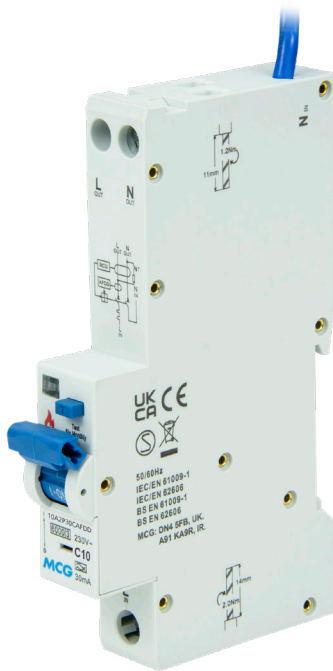

Series arcing faults:

These are typically caused by a loose connection or a damaged conductor. In this arc fault condition current flow is always lower than the operational load current.

Miniature Circuit Breakers and Residual Current protective devices will not detect these electrical faults.

However AFDDs are extremely sensitive and will disconnect series faults from 2.5A

Parallel arcing faults between conductors:

These are caused by electric arcs resulting from damage to the insulation that permits minimum contact between the two live conductors, MCBs or RCBOs may trip if the fault current is high enough.

Parallel arcing faults between phase (or neutral) and protective conductor:

AFDDs will detect arcing faults against the protective conductor and provide adequate fire protection where no RCD is used.

However MCG AFDDs are combined with 30mA Miniature RCBOs that reliably detect and shut down this type of parallel arc fault.

Test Button

Perform test every 6 months

Product Specification

Bidirectional	Yes
Rated Voltage	230V
RCD Type	A
Rated Current	10A
Frequency	50/60Hz
IP Rating	IP20
Weight	0.189kg
Number of Modules	1
Number of Poles	Single Pole & Neutral (Switched)
Rated Tripping Current $I_{\Delta n}$	30mA
Rated peak withstand voltage U_{imp}	4kV
Mounting	DIN Rail
Terminal Capacity	1 - 25mm ²
Torque Setting	1.2(L/N out)/2 (L in)
Rated Breaking Capacity	6kA
Electrical endurance	≥4000 switching operations
Mechanical endurance	≥10000 switching operations
Tripping Characteristics	C Curve
Busbar thickness	0.8 - 2mm
Colour	Grey/Blue
Tripping temperature	-25°C to +40°C
Material	Plastic
Compliance	UKCA, CE
Guarantee	1 Year
Supplied With	350mm Neutral cable Test 'T' operating test button on the front panel Fault tripping indicator window Insulated DIN rail clips
Standards	EN 62606, EN 61009-1
Depth	70mm
Height	118mm
Width	18mm

Errors and omissions excepted (E&OE). All information is subject to change without notice and is correct at the time of print. Refer to issue number and date below.

10A 1P+N Arc Fault Detection Device

Bidirectional 1 Module 6kA C Curve Type A
30mA

Product Ref: **10A2P30CAFDD**

Protective area

Combines integrated AFD, MCB and RCD devices. This allows to provide the highest protection level.

Protective Area

FAULT TYPE	DETECTED BY INTEGRATED
Short circuit	MCB
Overload	MCB
Residual current	RCD
Series Arcing Fault	AFD
Parallel Arcing Fault	AFD
Parallel Arcing Fault to PE	RCD

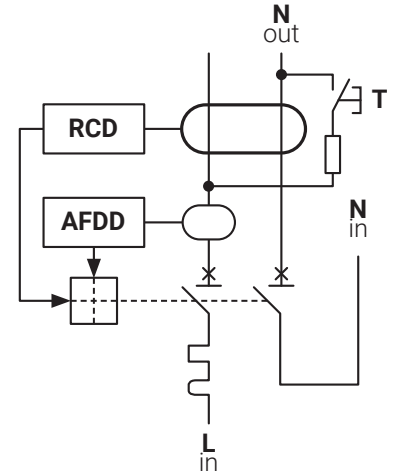
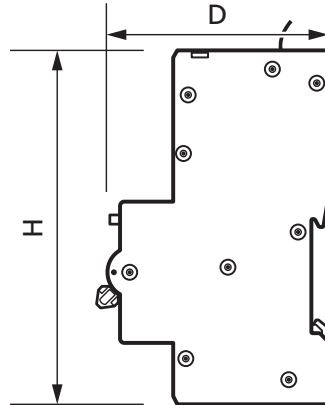

AFDD Part Operating Criteria

Series Arcing Fault

TEST CURRENT (A)	Maximum allowed tripping time(s)
2.5	1
5	0.5
10	0.25
16	0.15
32	0.12
40	0.12

Parallel Arcing Fault

TEST CURRENT (A)	Maximum allowed number of arcing half-waves within 0.5s (N)
75	12
100	10
150	8
200	8
300	8
500	8

LED Indication after tripping and re-closing

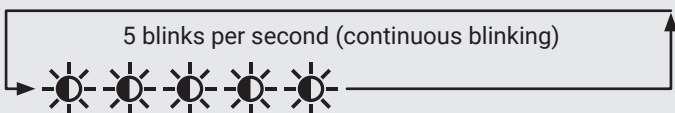
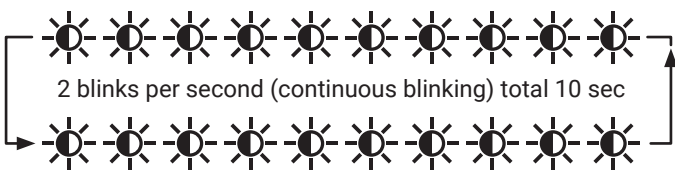
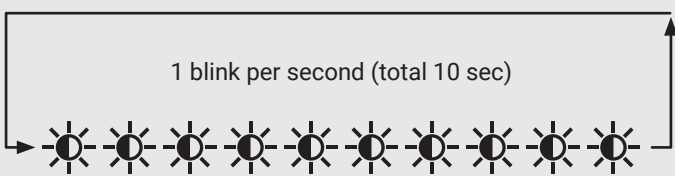
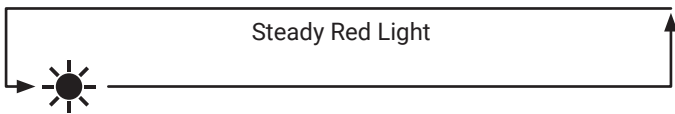

Description

