

16A 50m 110V Floor Cable Reel c/w Thermal Cutout

Product Ref: **CX5015FSTS 110V**

Technical Features:

- Suitable for a variety of industrial applications
- Thermal protection switch
- Floor standing
- Complete with 2 x 16A 2P+E 110V socket outlets
- 50m length 1.5mm² yellow Arctic grade cable
- Fitted with 16A 2P+E 110V Plug

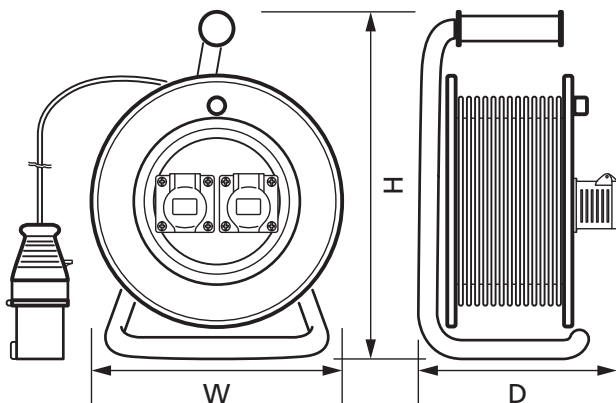

Product Specification

Fully Extended Power	1875W 110V
Voltage Rating	110-130V AC
Current Rating	16A
IP Rating	IP44
Weight	6.950kg
Cable Length	50m
Cable Size	H05VV-F 3G 1.5mm ²
Cable Type	1.5mm Yellow Arctic Grade
Number of Outlets	2
Thermal Protection	Yes
Mounting	Floor Standing
Colour	Yellow
Material	Metal / Plastic
Supplied With	110V 16A IP44 Plug
Class	Class I
Compliance	UKCA, CE
Guarantee	1 Year
Standards	BS EN 61242
Depth	208mm
Height	364mm
Width	263mm

Errors and omissions excepted (E&OE). All information is subject to change without notice and is correct at the time of print. Refer to issue number and date below.

Tel: +44 (0)1302 342 642 • mcg.co.uk • [@mcg_industrial](https://twitter.com/mcg_industrial)