

PG21 IP68 Compression Gland with Locknut Grey

Product Ref: **PG21G**

Technical Features:

- Nylon plastic construction
- Nitrile rubber hermetic seal
- Protection degree: IP68
- Ambient temperature quiescent state -40°C to 100°C (short time to 120°C)
- Dynamic -20°C to 80°C (short time to 100°C)
- Designed for use with round cable only

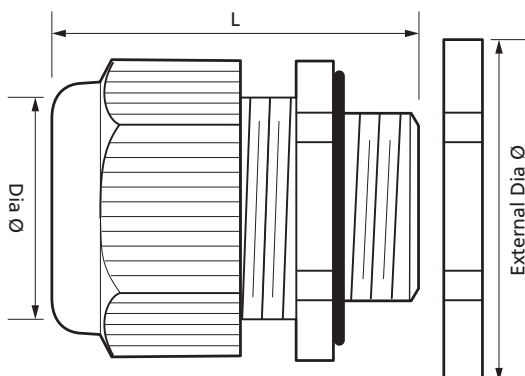

Product Specification

IP Rating	IP68
Weight	0.023kg
Size	PG21
Cable Size Range	13 - 18mm ²
Colour	Grey
Material	Nylon Plastic
Compliance	UKCA, CE
Guarantee	1 Year
Standards	BS EN/EN 62444 - Cable glands for electrical installations
Suitable for	13 - 18mm Diameter Cable
Diameter Ø	28.3mm
External Diameter Ø	46mm
Length	44mm

Errors and omissions excepted (E&OE). All information is subject to change without notice and is correct at the time of print. Refer to issue number and date below.

Tel: +44 (0)1302 342 642 • mcg.co.uk • [@mcg_industrial](https://twitter.com/mcg_industrial)