

DC Rotary Isolator

4P 25A 1500V / 32A 1000V

Product Ref: **SMI25-4DC**

Technical Features:

- Rated up to 1500V DC (DC-21B & DC-PV2)
- Padlockable in OFF position for added security (up to 3 padlocks)
- Excellent switching and high short circuit capacity
- Suitable for Photovoltaic - Isolators, Inverter Applications, DC Solar Pumps
- BS EN60947-1/3
- Insulated enclosure flame retardant material
- Wiping contacts
- Interlock Feature (Cover opens only in OFF position)
- Knockout cable entries (x2 25mm, x4 M25)



Product Specification

Current Rating	25A
IP Rating	IP66
Weight	0.656kg
Number of Poles	4 Pole
Mounting	Surface
Cable Entry	Knockout Cable Entries
Lockable	Yes
Colour	Grey
Material	PC
Operating Temperature Range	-5°C to 40°C
Compliance	UKCA, CE
Guarantee	1 Year
Standards	IEC/EN 60947-1/3
Depth	74mm
Height	160mm
Width	100mm

Configuration	IEC Rating 60947-3 - DC21B & DC PV2			
	500V	700V	1000V	1500V
 2 Poles in series	20	20	-	-
 2 Poles in series + 2 Parallel	63	32	16	4
 4 Poles in series	32	32	32	25

Terminal Cross Section	
Single / Multi Strand Wire	2.5 - 10mm ²
Fine Strand Wire with Sleeve	0.75 - 6mm ²
Recommended Tightening Torque for Terminals	1.7Nm

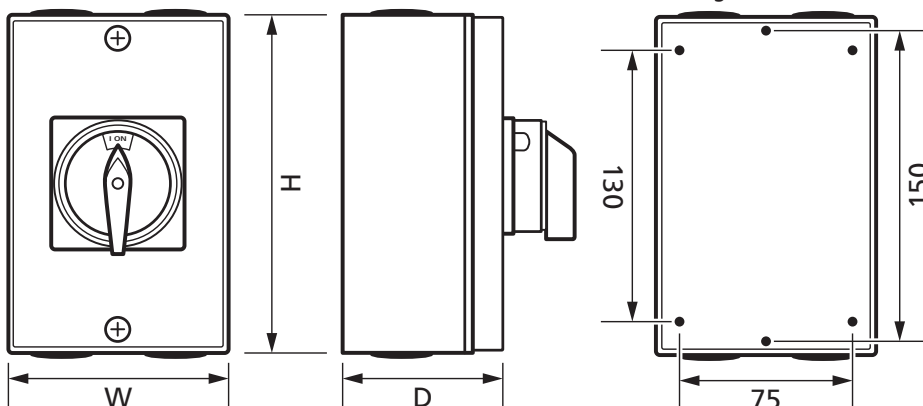

Errors and omissions excepted (E&OE). All information is subject to change without notice and is correct at the time of print. Refer to issue number and date below.

DC Rotary Isolator

4P 25A 1500V / 32A 1000V

Product Ref: **SMI25-4DC**

Switching Configurations - Examples

Type	2 Poles	2+2 poles, 2 poles in series + 2 poles in parallel	4 Poles	4 Poles with Jumper Links	
Contacts Wiring Diagram					
Switching Example					

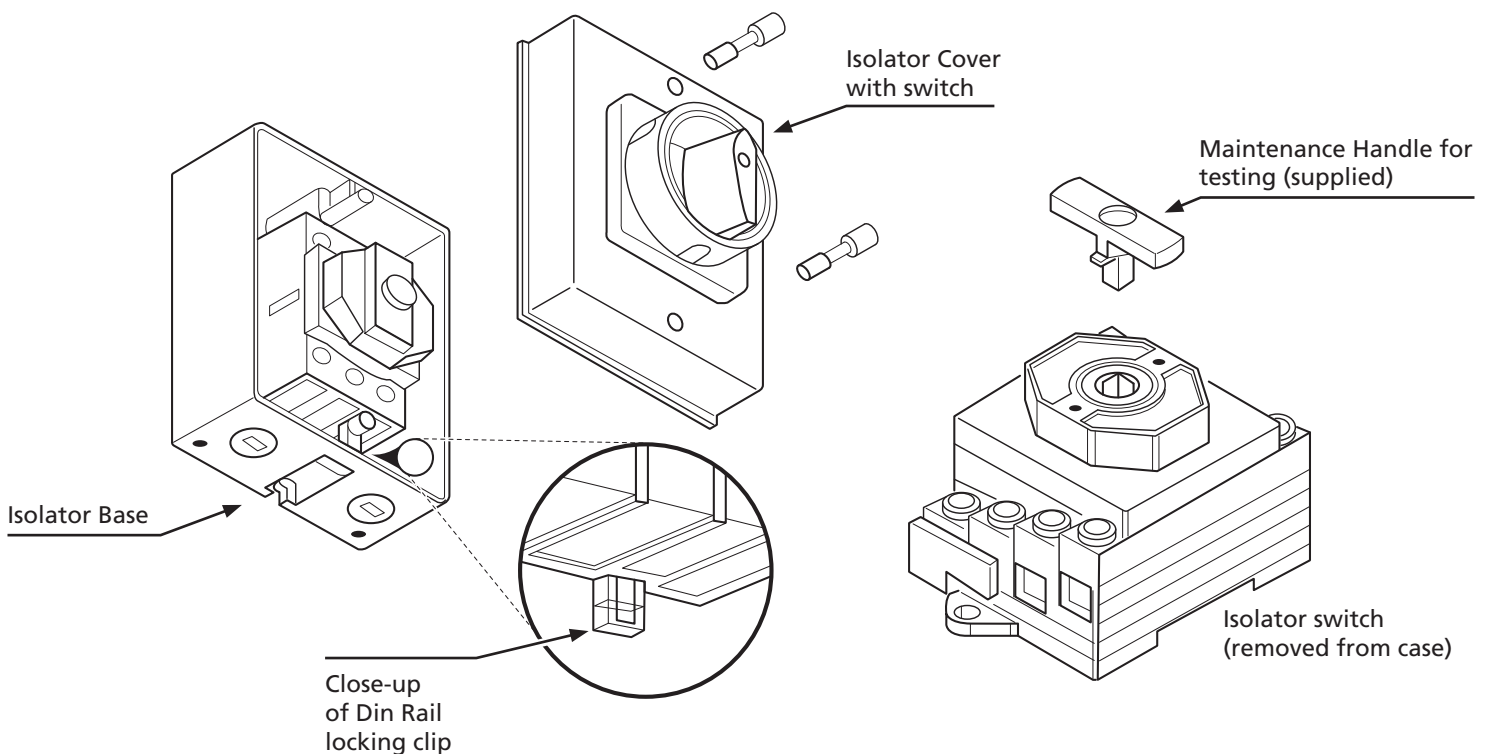

Errors and omissions excepted (E&OE). All information is subject to change without notice and is correct at the time of print. Refer to issue number and date below.