

32A 8 Pole Surface Mounting Rotary Isolator Plastic Enclosure IP65

Product Ref: **SMI32-8**

Technical Features:

- Insulated enclosure flame retardant material
- Low smoke and halogen free
- Easy access and switch removal
- Padlockable for added security
- Knockout cable entries
- Switch ratings at AC22

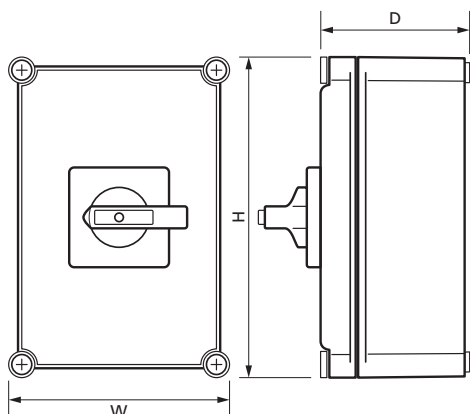

Product Specification

Voltage Rating	690V
Current Rating	32A
IP Rating	IP65
Weight	1.574kg
Number of Poles	Eight Pole
Mounting	Surface
Cable Entry	Knockout Cable Entries
Lockable	Yes
Colour	Red/Yellow/Grey
Material	ABS
Compliance	UKCA, CE
Guarantee	1 Year
Standards	IEC/EN 60947-1, IEC/EN 60947-3
Depth	130mm
Height	280mm
Width	190mm

Errors and omissions excepted (E&OE). All information is subject to change without notice and is correct at the time of print. Refer to issue number and date below.

Tel: +44 (0)1302 342 642 • mcg.co.uk • [@mcg_industrial](https://twitter.com/mcg_industrial)