

DTRD2030A

NHP DIN-T Residual Current Breaker RCBO 10kA 1 Pole and Switched Neutral 20A C Curve 30mA Type A



Component type	Earth leakage circuit breaker
Range	DIN-T RCD
Model	N/A
Product status	Existing

NHP's DIN-T range of residual current devices (RCDs) are a high-performance electrical safety solution designed for commercial, industrial and mining applications. These RCDs offer a high level of selectivity, with sensitives including 10mA, 30mA, 100mA and 300mA, and types starting at Type A for general purpose applications through to Type F and B for more complex loads.

Rated current	20 A
Rated voltage	240 V
Rated leakage current	30 mA
Frequency	50/60 Hz
Rated short-circuit breaking capacity according to AS/NZS 61009	10 kA
Voltage type	AC
Trip curve	C
Rated impulse withstand voltage Uimp	4 kV
Leakage current type	A
Tripping time	300 ms
Min. service voltage	110 V
Max. operating voltage (Umax)	264 V
Rated residual make/break capacity	6000 A
Protected neutral pole	No
Number of poles (total)	2
Electrical life at Un, In (service cycles)	10000 cycles
Type of electric connection	Fork and pin
Isolator application	Yes
Rated insulation voltage Ui	500 V
Concurrently switching neutral conductor	Yes
Mounting method	DIN rail
IP rating	IP40
Number of protected poles	1
Mechanical life (service cycles)	20000 cycles
Disconnection characteristic	Undelayed

ELECTRICAL

CONSTRUCTION

MECHANICAL

DTRD2030A

NHP DIN-T Residual Current Breaker RCBO 10kA 1 Pole and Switched Neutral 20A C Curve 30mA Type A



MECHANICAL	Connectable conductor cross section solid-core	1-35 mm ²
	Connectable conductor cross section multi-wired	1-35 mm ²
	Max. shock duration	13 ms
	Max. shock acceleration	25 g
	Max. vibration frequency, operational	150 Hz
DIMENSIONS	Depth	75 mm
	Height	85 mm
	Width	35 mm
	Weight	0.2 kg
	Width in number of modular spacings	2
ENVIRONMENT	Operating temperature	-25...70 °C

DTRD2030A

NHP DIN-T Residual Current Breaker RCBO 10kA 1 Pole and Switched Neutral 20A C Curve 30mA Type A



CIRCUIT DIAGRAM

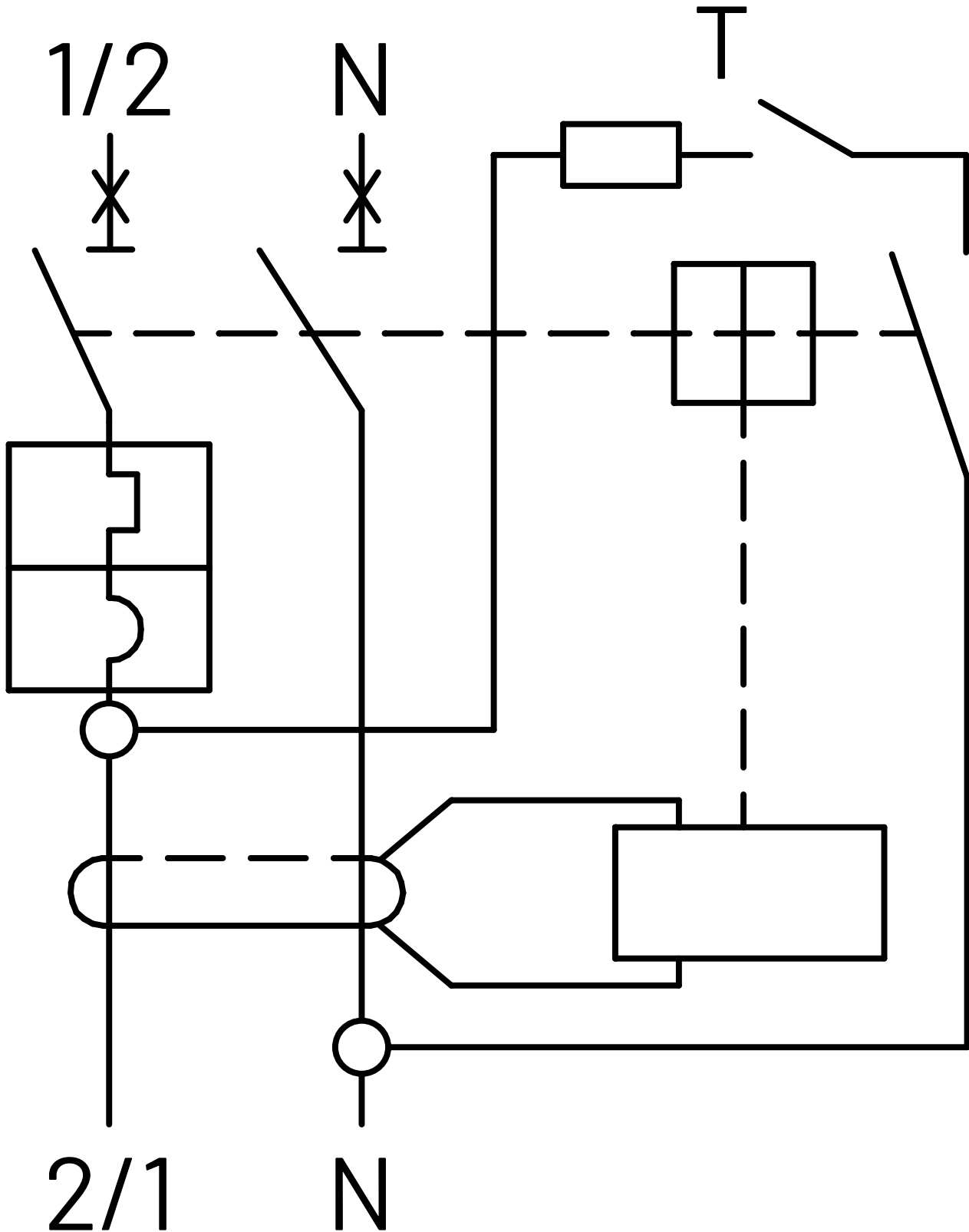

DTRD2030A

NHP DIN-T Residual Current Breaker RCBO 10kA 1 Pole and Switched Neutral 20A C Curve 30mA Type A



DIMENSIONAL DIAGRAM

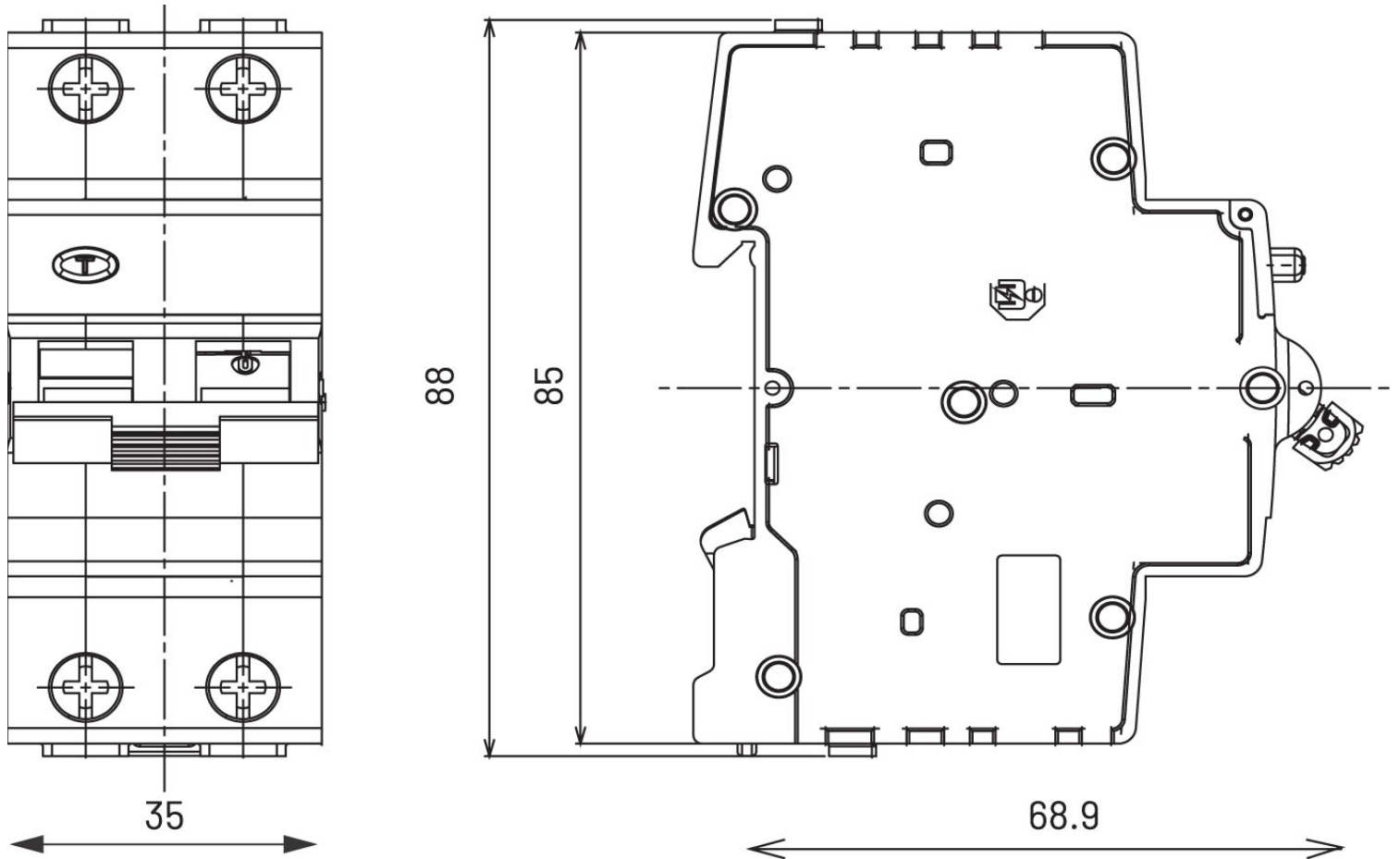

RELATED PRODUCTS

ACCESSORY



Item No: DTAAXAL

Required: No

Description: NHP DIN-T Accessory Auxiliary/Alarm 1 Changeover Contact suits DIN-T DTM and DTR

Item No: DTALBAX

Required: No

Description: NHP DIN-T LOCKDIN Auxiliary Filler 9mm, 18mm, 27mm Pack Qty 10 each

Item No: DTALDC

Required: No

Description: NHP DIN-T Lock Toggle Device 1P/2P MCB



Item No: DTALDTRD

Required: No

Description: NHP DIN-T LOCKDIN RCBO 2P DTRD



Item No: DTALPF

Required: No

Description: NHP DIN-T Accessory Pole Filler to suit 63mm 3P Strip 54mm 6x9mm Segments



Item No: DTASHT110415V

Required: No

Description: NHP DIN-T Accessory Shunt Trip 110-415 V AC/DC suits DIN-T DTM and DTR

DTRD2030A

NHP DIN-T Residual Current Breaker RCBO 10kA 1 Pole and Switched Neutral 20A C Curve 30mA Type A



RELATED PRODUCTS

ACCESSORY



Item No: DTASHT12110V

Required: No

Description: NHP DIN-T Accessory Shunt Trip 12-110 V AC/DC suits DIN-T DTM and DTR



Item No: DTAUVT240V

Required: No

Description: NHP DIN-T Accessory Undervoltage Trip 240 V AC/DC suits DIN-T DTM and DTR



Item No: DTAUVT24V

Required: No

Description: NHP DIN-T Accessory Undervoltage Trip 24 V AC/DC suits DIN-T DTM and DTR



Item No: DTLD

Required: No

Description: NHP DIN-T LOCKDIN Locking Device Removable Individual Piece 8mm



Item No: DTPF12

Required: No

Description: NHP DIN-T Accessory Pole Filler 12Pole Strip 216mm equals 24 x 9mm Segments



Item No: DTT9025PN

Required: No

Description: NHP DIN-T Miniature Circuit Breaker Terminal Insulated 90 Degrees 25mm Pin



Item No: DTTAX25PN

Required: No

Description: NHP DIN-T Accessory Terminal Axial Pin 25mm



Item No: DTTAX25SP

Required: No

Description: NHP DIN-T Accessory Terminal Axial Spade 25mm



Item No: DTTAX50PN

Required: No

Description: NHP DIN-T Accessory Terminal Axial Pin 50mm



Item No: DTTTLT25PN2

Required: No

Description: NHP DIN-T Miniature Circuit Breaker Terminal Axial Pin 25mm Long Insulated



Item No: DTTTLT35LPN

Required: No

Description: NHP DIN-T Accessory Terminal Lateral Pin 35mm Long



Item No: DTTTLT35PN

Required: No

Description: NHP DIN-T Accessory Terminal Lateral Pin 35mm Short

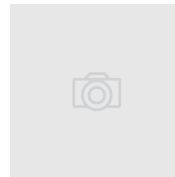

Item No: ICL102

Required: No

Description: NHP DIN-T Miniature Circuit Breaker Bus Comb 10 Way 1Pole N Pin Type 80A End Feed 130A Centre Feed



Item No: ICL562

Required: No

Description: NHP DIN-T Miniature Circuit Breaker Bus Comb 56 Way 1Pole N Pin Type 80A End Feed 130A Centre Feed



Item No: ICL62

Required: No

Description: NHP DIN-T Miniature Circuit Breaker Bus Comb 06 Way 1Pole N Pin Type 80A End Feed 130A Centre Feed



Item No: ICLC23

Required: No

Description: NHP DIN-T Miniature Circuit Breaker Busbar Comb Endcap for 2 and 3Pole ICL and 3 Auxiliary



Item No: ICLTOC

Required: No

Description: NHP DIN-T Miniature Circuit Breaker Busbar Comb Tee Off Cap Strip of 5