

MD6R41630A

NHP MOD6+ RCBO 6kA 3 Pole and Switched N 16A C Curve
30mA Type A



Component type	Earth leakage circuit breaker
Range	MOD6+ Residual Current Devices
Model	N/A
Product status	New Item

NHP MOD6+ Residual Current Devices (RCDs) offer a 6kA rating with a proven history in domestic and commercial applications. The MOD6+ RCD range offers many solutions for both 1 phase in 10mA and 30mA sensitivities as well as 3 phase in 30mA sensitivities. The MOD6+ RCDs can be easily installed into NHP Loadcenters, as well as MOD6+ RCBOs into MOD6+ Distribution Panelboards.

ELECTRICAL

Rated current	16 A
Rated voltage	415 V
Rated leakage current	30 mA
Frequency	50/60 Hz
Rated short-circuit breaking capacity according to AS/NZS 61009	6 kA
Voltage type	AC
Trip curve	C
Rated impulse withstand voltage Uimp	4 kV
Leakage current type	A
Tripping time	300 ms
Min. service voltage	195 V
Max. operating voltage (Umax)	440 V
Rated residual make/break capacity	4500 A
Protected neutral pole	No
Number of poles (total)	4
Electrical life at Un, In (service cycles)	10000 cycles
Type of electric connection	Pin
Isolator application	Yes
Rated insulation voltage Ui	500 V
Concurrently switching neutral conductor	Yes

CONSTRUCTION

Mounting method	DIN rail
IP rating	IP40
Number of protected poles	3
Mechanical life (service cycles)	20000 cycles
Disconnection characteristic	Undelayed

MECHANICAL

MD6R41630A

NHP MOD6+ RCBO 6kA 3 Pole and Switched N 16A C Curve
30mA Type A



MECHANICAL	Connectable conductor cross section solid-core	1-25 mm ²
	Connectable conductor cross section multi-wired	1-25 mm ²
	Max. shock duration	13 ms
	Max. shock acceleration	30 g
DIMENSIONS	Depth	72 mm
	Height	75 mm
	Width	70.5 mm
	Weight	0.48 kg
	Width in number of modular spacings	4
ENVIRONMENT	Operating temperature	-25...55 °C
	Pollution degree	2

MD6R41630A

NHP MOD6+ RCBO 6kA 3 Pole and Switched N 16A C Curve
30mA Type A



CIRCUIT DIAGRAM

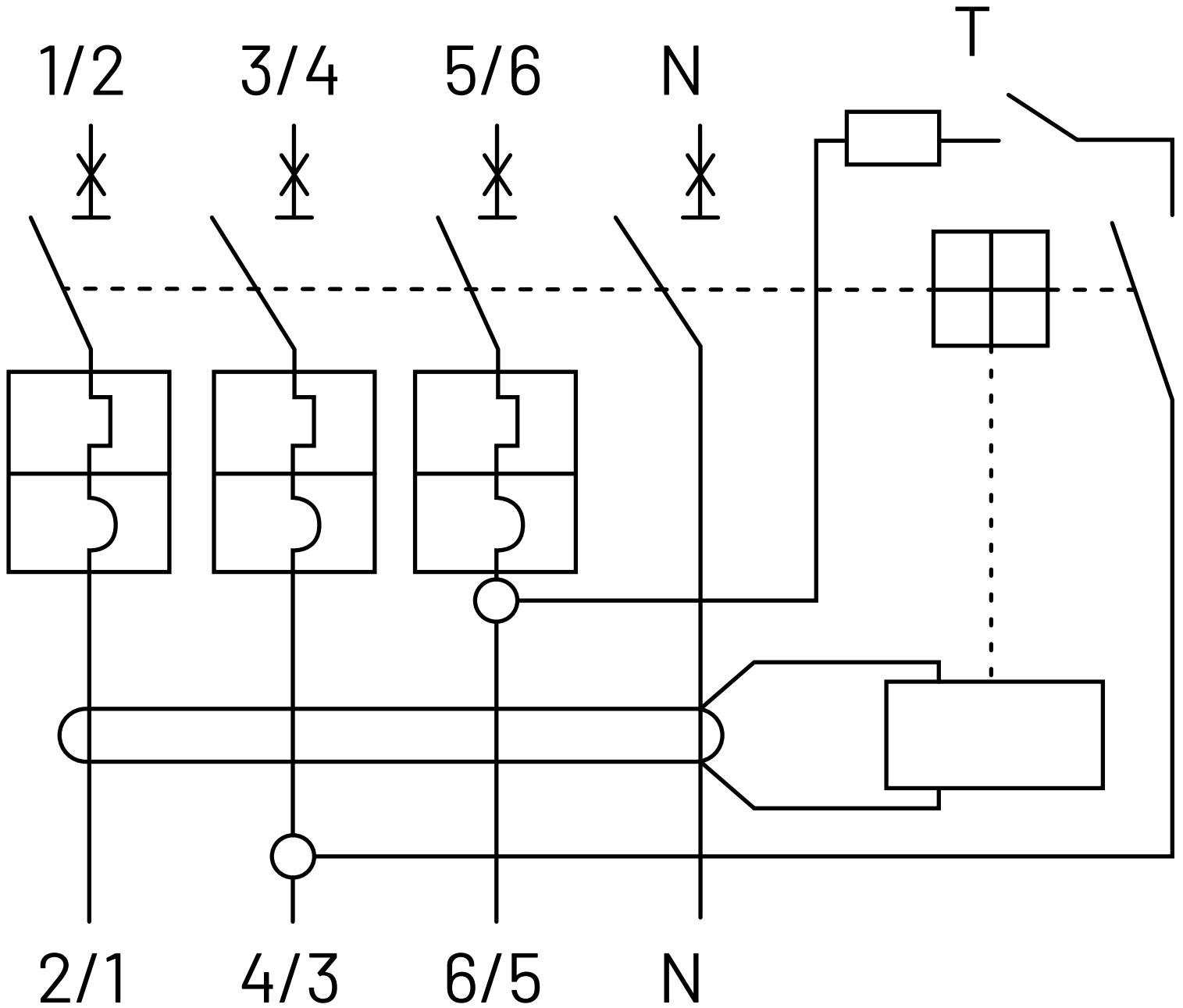

MD6R41630A

NHP MOD6+ RCBO 6kA 3 Pole and Switched N 16A C Curve
30mA Type A



DIMENSIONAL DIAGRAM

