

# INCEPTOR® ACE

## Technical Specification

Product Code: OV102100BKCW

Description: 100W LED Asymmetric Floodlight - IP65 - 4000K - Black

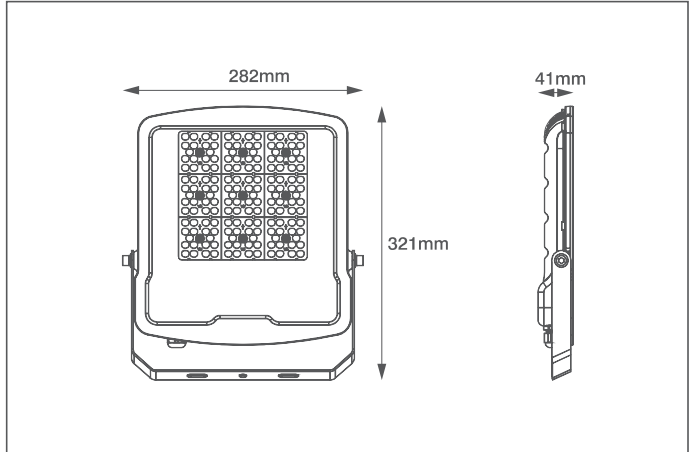

### General Information

Dimensions (mm)	282 (W) x 321 (H) x 41 (D)
Materials	Body: Powdercoated Aluminium Diffuser: Glass
Finish	Black (RAL 9004)
Product Weight (Kg)	2.13
Ingress Protection	IP65
Impact Rating (IK)	06
Warranty (Years)	5

### Supply & Power Information

Input Voltage & Frequency (V~ / Hz)	220-240 50/60
Safety Class	I
Circuit Wattage (W)	100
LED Wattage (W)	100
Input Current (mA)	560
Inrush Current/Time	30A (500µS)
Power Factor	>0.9
Operating Temperature (°C)	-20 to +40
Critical Temperature (°C)	+50
Input Mains Cable	3 x 1mm <sup>2</sup> H05-RNF (2 metre)

### Luminaire Output

Colour Temperature (K)	4000
Colour Render Index (CRI)	>80
Efficacy (lm/W)	120
Beam Angle (°)	60 x 120
LED Lifetime (L70) (Hours)	50,000

### Dimming Information

Dimmable	No
Dimming Format	Non-Dimmable

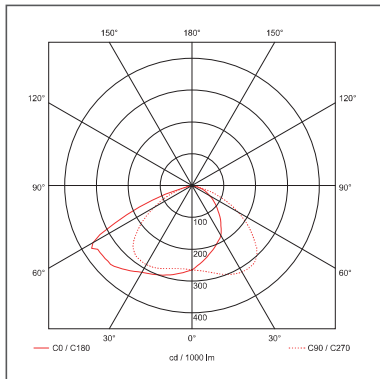

Ovia Limited, Scolmore House, Mariner, Lichfield Road Industrial Estate, Tamworth, Staffordshire, B79 7UL United Kingdom

T: +44 (0)1827 300640

E: sales@oviaUK.com | W: oviaUK.com