

INCEPTOR® A-LITE

Technical Specification

Product Code: OV841560MWCTA

Description: 60W 1500mm Linear Batten CTA Switchable LED Light - Microwave Sensor

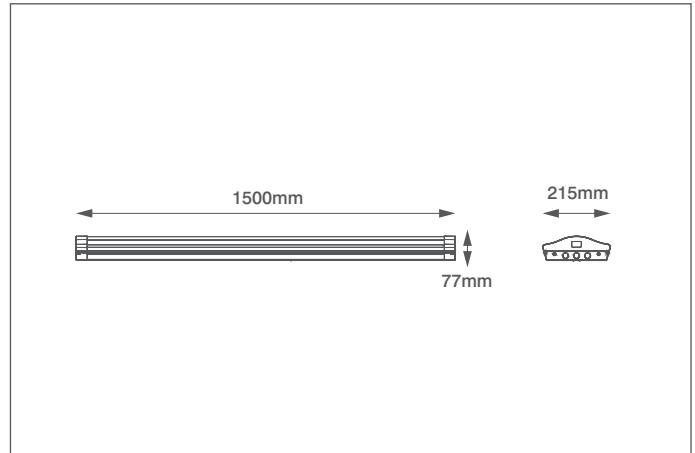

General Information

Dimensions (mm)	1500 (L) x 215 (W) x 77 (D)
Materials	Base: Powdercoated Steel Opaque Diffuser: Polycarbonate
Finish	White (RAL 9016)
Product Weight (Kg)	3.5
Ingress Protection	IP20
Impact Rating (IK)	06
Flammability Rating	TP(b)
Mounting	Ceiling, Wall or Suspended
Fixing Components Supplied	Wall Plugs, Washers & Screws Supplied
Warranty (Years)	5

Luminaire Output

Colour Temperature (K)	3000	4000	6000
Typical Luminous Flux (lm)	6550	7300	6850
Efficacy (lm/W)	110	125	115
Beam Angle (°)	120		
Colour Rendering Index (CRI)	>80		
Flicker Free	Yes		
LED Lifetime (L70) (Hours)	50,000		

Dimming Information

Dimmable	No
----------	----

Sensor Information

Detection Area Settings (%)	10 / 50 / 75 / 100
Detection Angle (°)	120
Daylight Threshold Settings (Lux)	2 / 10 / 50 / Disable
HF System	5.8GHz ±75MHz
Master/Slave Facility	Up to 400W
Hold Time Settings	5s / 90s / 5min. 15min.

Supply & Power Information

Input Voltage & Frequency (V~ / Hz)	220-240 50
Safety Class	I
Circuit Wattage (W)	60
LED Wattage (W)	60
Input Current (mA)	260
Inrush Current	13.6A (330µs)
Power Factor	>0.9
Operating Temperature (°C)	-20 to +60
Maximum Critical Temperature (°C)	+90
Input Terminations	3 Pole Push Fit Terminal Block

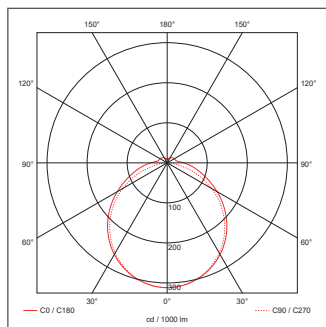

3000

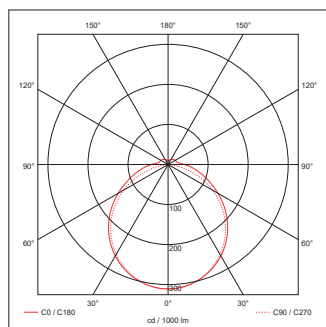

4000

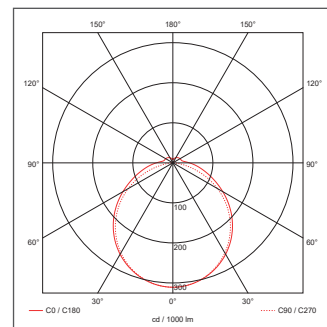

6000



Ovia Limited, Scolmore House, Mariner, Lichfield Road Industrial Estate, Tamworth, Staffordshire, B79 7UL United Kingdom

T: +44 (0)1827 300640

E: sales@oviaUK.com | W: oviaUK.com