

Universal Power Rail

UPR-03

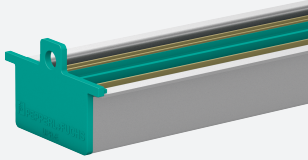

- 35 mm DIN mounting rail with 3-conductor insert
- Provides DC supply voltage to all equipped K-System modules
- Standard length 2 m (6 foot), simple to customize to application space
- Eliminates daisy-chains

Universal Power Rail with end caps and cover, 3 conductors, length: 2 m

Function

The Power Rail consists of a DIN mounting rail UPR-MR and a insert UPR-INS-03. The component has two conductors for power and one conductor for collective error messaging. The component reduces wiring and maintenance costs because it eliminates the need to daisy-chain the wires. It also simplifies expansion – just snap in a new isolator when you're ready to expand a system. The component comes in 2 m segments but can be cut to any size. The Power Rail is delivered with two UPR-E end caps and UPR-COVER cover. All components of the Power Rail can be ordered separately. In conjunction with K-System modules the component can be mounted in Zone 2.

Assembly

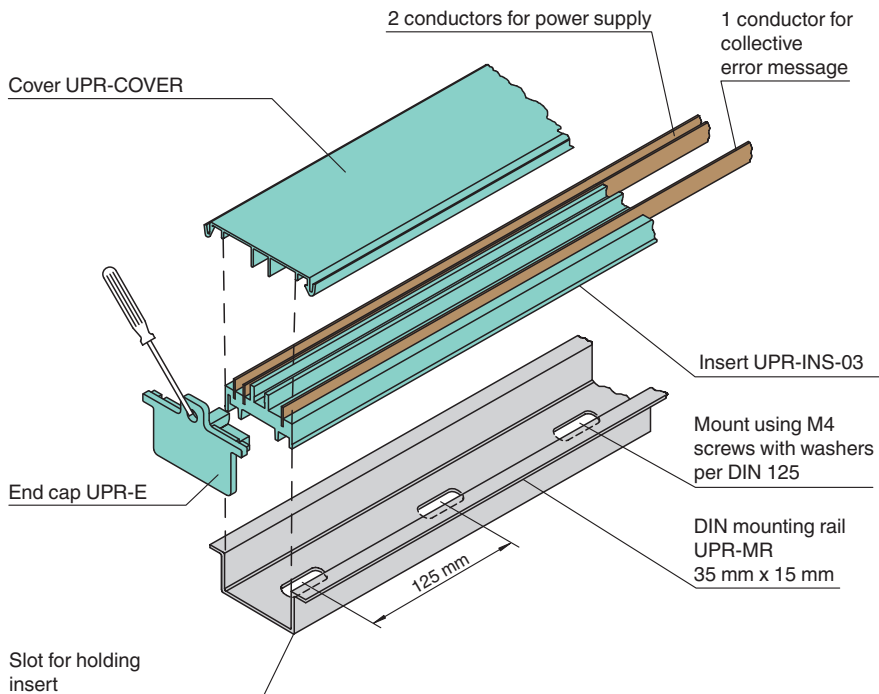

Technical Data

Electrical specifications

Rated voltage	U_r	24 V DC
Rated current	I_r	4 A

Release date: 2023-05-05 Date of issue: 2023-05-05 Filename: 119265_eng.pdf

Refer to "General Notes Relating to Pepperl+Fuchs Product Information".

Pepperl+Fuchs Group
www.pepperl-fuchs.com

USA: +1 330 486 0002
pa-info@us.pepperl-fuchs.com

Germany: +49 621 776 2222
pa-info@de.pepperl-fuchs.com





Singapore: +65 6779 9091
pa-info@sg.pepperl-fuchs.com

PF PEPPERL+FUCHS

Technical Data

Ambient conditions		
Ambient temperature		-40 ... 70 °C (-40 ... 158 °F)
Mechanical specifications		
Connection		3 conductors
Supply		2 Conductors
Fault output		1 Conductors
Dimensions		35 x 15 x 2000 mm (1.4 x 0.6 x 78.7 inch) (W x H x L)
General information		
Scope of delivery		- DIN mounting rail UPR-MR - insert UPR-INS-03 - cover UPR-COVER - end cap UPR-E

Accessories

	UPR-E	End cap for universal power rail UPR-**-*
	UPR-I	Insulation spacer for universal power rail UPR-**-*
	UPR-MR	35 mm DIN mounting rail, length: 2 m (packaging unit: 2 pieces)
	UPR-INS-03	Insert for 35 mm DIN mounting rail
	UPR-COVER	Cover for 35 mm DIN mounting rail

Release date: 2023-05-05 Date of issue: 2023-05-05 Filename: 119265_eng.pdf

Refer to "General Notes Relating to Pepperl+Fuchs Product Information".

Safety Information



Cover empty, open segments of the Power Rail. Use the supplied cover. Thereby Power Rail will be protected from pollution. The contact with electrically conductive parts on Power Rail will be prevented.