

Product Code:	Product Range:	Issue Date:	Issue by:
SF63	Single Phase Switch Fuses	15/03/18	S.A.H.

Description:

63A Single Pole plus Neutral Switch complete with 63A High Rupturing Capacity Fuse

Features:

- Incorporating DP isolator and BS88 fuse all enclosed in a robust metal clad enclosure
- Isolation switch can be locked in ON or OFF position



Technical:

Standard	BS EN 61947 parts 1&3, BS 88 pt 2
Current Rating	63 A
Voltage Rating	230 V / 400 V
Material	Polyester Powder Coated Steel Construction
Colour	Grey
Cover Door	Top Hinged Steel Door
IP Rating	IP30
Cable Entry	Knockouts 2x 20mm & 2x 25mm
No. of Outgoing Ways	1
Utilisation	AC22B

Switchgear Fitted:

Device	Rating	No. of Outgoing Ways
Isolator Incomer	63A	-
HRC Fuse	63A (Max.)	1

Replacement Fuse Link

3493-M



General Device Specification:

Isolator:

BSEN60947-3
230 - 400V AC
AC22B
Terminal Capacity = 50 mm² (In/Out)

Fuse:

BS88-pt6: 1988
400V AC
80kA
Type - gG
Terminal Capacity = 35 mm² (In/Out)

Product Code:

SF63

Product Range:

Single Phase Switch
Fuses

Issue Date:

15/03/18

Issue by:

S.A.H.

Dimensions:

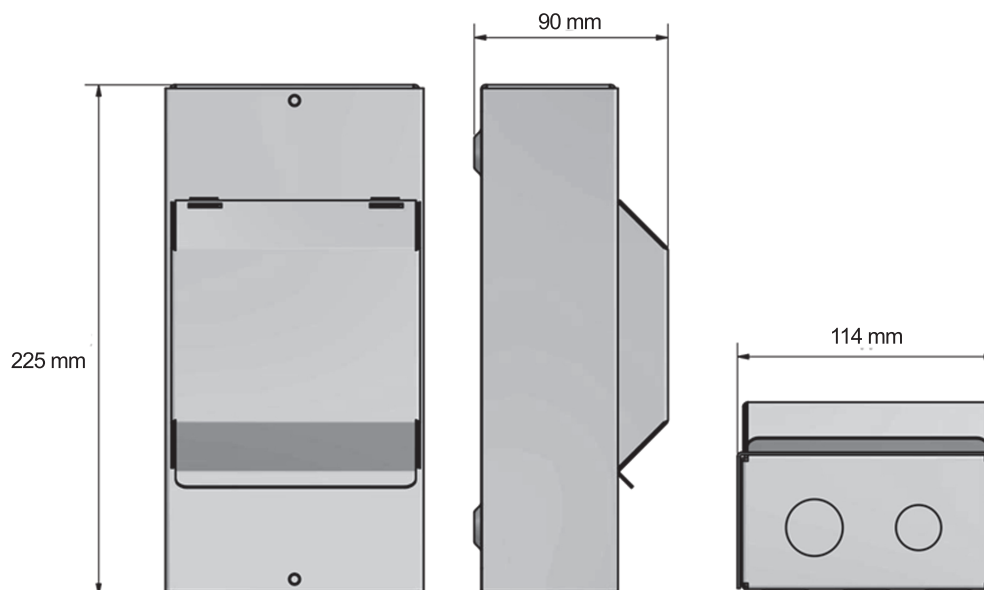

Additional Information:

Electrical

Earth terminals - 2 x 25mm² + 2 x 16mm²

Rated frequency: 50Hz

Rated operational voltage: 230/400V a.c

Rated insulated voltage: 300/660V a.c

Short circuit withstand: 16kA rms (based on the use of BS1361 Type 2 fuse of rating not exceeding 100A).

Earthing system: Suitable for use with TN-S, TN-C-S and TT systems.

EMC environment: Environment type 1.

Physical

Ambient operating -5°C to +40°C temperature: (Not exceeding an average of more than 25°C in any 24 hour period)

IP rating: IP30

Enclosure: Metalclad base and main cover powder coated in hardwearing epoxy light grey paint ref.

RAL7035.

Installation

Service conditions: Wiring of this product must comply with current IEE regulations. Units are intended for indoor use and dry conditions and not where high levels of humidity and temperature are experienced.

Note: IP rating of enclosure can be compromised if correct use of glands and knockouts is not followed when installing unit.