

Product Code	Product Range	Issue No.	Issue Date	Issue By
M2324	Isolators	C	August 2025	T.T.

Description

IP67 4 pole, switch disconnecter in glass fibre, reinforced, unsaturated, polyester resin enclosure.

Features

- Modern design and manufacturing process.
- IP67 ingress protection allows installation in the most severe conditions.
- High switching capacity.
- Strong, high impact resistance enclosure.
- Dedicated LOCK OFF position prevents removal of front cover when padlocked.
- Flame resistant and anti-carbonisation.



General Characteristics

Standards	BS EN 60947-1 & 3. EN 60529.
Current Rating (In) at 40°C. AC22A	32A 690V.
AC23A	32A 415V. 25A 500V & 690V.
Maximum operating voltage	690V maximum.
Rated Insulation Voltage (Ui) AC 50-60Hz	800V
Rated Impulse Withstand Voltage (Uimp) AC 50-60Hz	8kV
Rated short circuit making capacity (690V)	1800A
Rated Conditional Short-Circuit (415V)	10kA – 32A backup fuse.
Rated short time withstand – 1s	1260A
Maximum altitude	2000m
Electrical endurance operations	20000
Handle	2 padlock positions in Lock Off position. Padlock not supplied. Interlocked in ON position.
Padlock diameter	6 – 8mm
Polarity	Bi-directional
IP Rating	IP67 conforming to IEC 60529
Pollution Degree	3
Operating temperature	-25C to 40C (40C at 50% relative humidity).
Terminal Capacity	0.75 - 10mm ²
Terminal Torque	1.2 Nm maximum.
Cable entry facility	2x M20/25 knockout's – top, bottom, & rear. 2x M16 knockouts each side.
Equipment Type / Mounting	Fixed / Screw to surface
Altitude	2000m.
Weight	581g
Resistance to climatic conditions	acc. to IEC 60068-2-30: 28 cycles (55 °C, 95 % relative humidity)
Impact Resistance	IK 08
Auxiliary contact – 1NO, 1 NC (optional)	Part no. M2A11



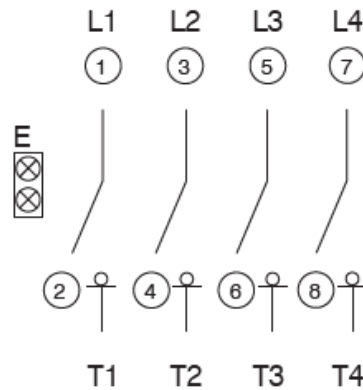
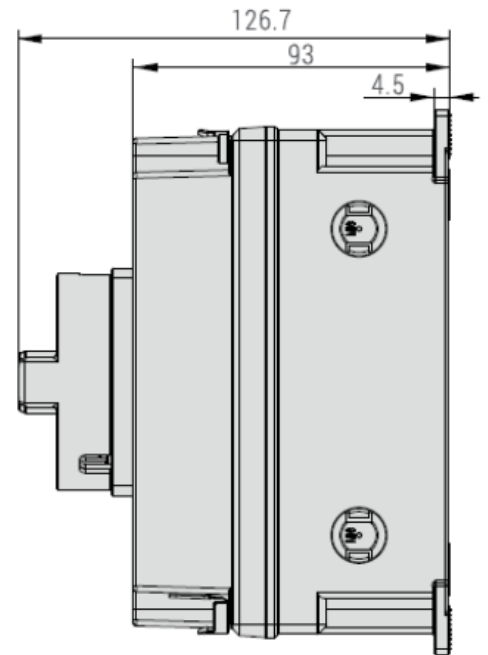
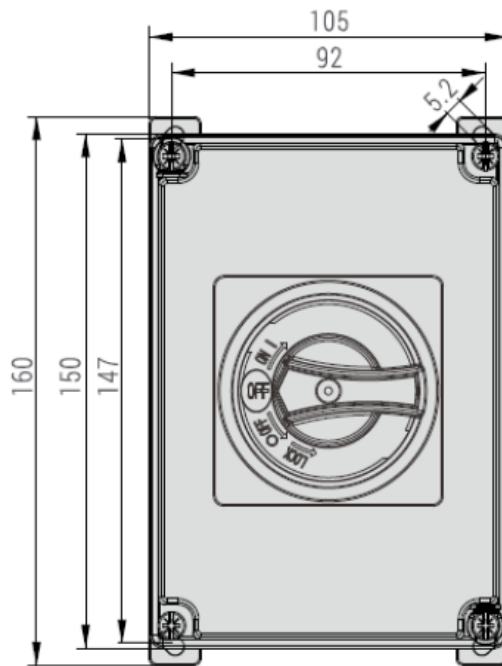

Fixing Centres:

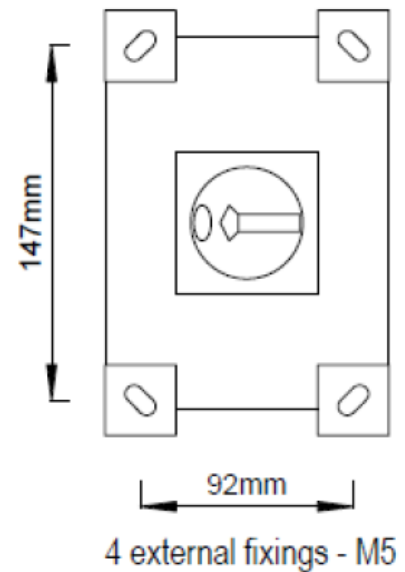

This isolator should not be operated when submerged.

IP67 definition:

6 - Completely protected against dust ingress.

7 – Temporary protection against immersion in water up to 1m depth. Water must not penetrate in harmful quantities in prescribed conditions.

Suitably IP rated glands must be used.