

Low Voltage Switchgear

Disconnect Switches





Innovation. Technology. Quality.

Switchgear from Sälzer: Solutions for the future!

Since 1956 Sälzer has specialised in the development, manufacture and sale of low voltage switchgear.

The large selection of types, switching programmes and mounting forms mean that practical reliable solutions can be achieved quickly. Whatever the switch, all individual parts are optimally co-ordinated, easy to assemble and combine.

Whether in switching and automation systems, mechanical engineering and construction, in the heating, climatic and ventilation industry, environmental technology or other areas: Sälzer switches provide safety!

Product support, training and service as well as a Certified Quality Management to DIN EN ISO 9001 are an essential part of our daily work. Our switches comply with national and international standards (IEC / cUL / GOST) and are suitable for world-wide application.

Special requirements?

Call us, we'll help you find an individual solution for your switching needs.

Our project engineers are here to understand the special requirements of your project and assist to develop a solution as a partner.

Should your requirements not be covered by our extensive standard product range we have our own Design and Development Department for special switches in order to flexibly, promptly and cost effectively meet your individual requirements.

Disconnect Switches

as of p.8

Safe switching and disconnecting

SMD – Sälzer Modular Design



Faster delivery by SMD!

The SMD (Sälzer Modular Design) is based on a modular product idea so that very high flexibility in product options is possible.

SMD modules are individually prefabricated and tested complete modules. By combining these basic elements, different switch configurations can be realised within short time spans. The switches required by you, the customer, are available for despatch following the assembly of the basic switch module to the mounting form and operator modules (SMD Service).

Within 24 hours, the solution matched to your requirements is ready for despatch – worldwide.

Table of Contents

	page
Info: New in this catalogue	6
Disconnect Switches	8
Product overview , mounting options	10
Setup of order code number	11
Main/Emergency-Off Switches	12
Front mounting Four hole mounting	12
Front mounting Single hole mounting	17
Base mounting Snap-on mounting for DIN Rail	19
Base mounting Snap-on mounting with door interlock	21
Base mounting Four hole mounting with door interlock	29
Enclosed switches with insulated enclosure	31
Enclosed switches with insulated enclosure for EMC/EMV application	37
Enclosed switches with mild steel enclosure	38
Enclosed switches with stainless steel enclosure	44
Main Switches	46
Front mounting Four hole mounting	46
Front mounting Single hole mounting	51
Base mounting Snap-on mounting for DIN Rail	53
Base mounting Snap-on mounting with door interlock	55
Base mounting Four hole mounting with door interlock	63
Enclosed switches with insulated enclosure	65
Enclosed switches with insulated enclosure for EMC/EMV application	71
Enclosed switches with mild steel enclosure	72
Enclosed switches with stainless steel enclosure	78

	page
ON-OFF Switches	80
Front mounting Four hole mounting	80
Front mounting Single hole mounting	84
Base mounting Snap-on mounting for DIN Rail	86
Base mounting Snap-on mounting with door interlock	88
Base mounting Four hole mounting with door interlock	96
Enclosed switches with insulated enclosure	98
Enclosed switches with insulated enclosure for EMC/EMV application	103
Enclosed switches with mild steel enclosure	104
Enclosed switches with stainless steel enclosure	107
Changeover Switches	109
Front mounting Four hole mounting	109
Front mounting Single hole mounting	112
Base mounting Snap-on mounting for DIN Rail	113
Base mounting Snap-on mounting with door interlock	115
Base mounting Four hole mounting with door interlock	120
Enclosed switches with insulated enclosure	122
Enclosed switches with insulated enclosure for EMC/EMV application	126
Enclosed switches with mild steel enclosure	127
Enclosed switches with stainless steel enclosure	130
Technical Information	132
Switching diagrams	132
Additional modules	141
Accessories	145
Operator variants	149
Utilization categories	151
Rated currents of three-phase motors	152
Degree of protection	153
Technical Data	154
Mounting form table	156
Contacts	158

New product line B200 – Types B240, B250 and B263

The new product line B200, is a solution for the increasing demands in many areas of connection technology.

With new robust and increased capacity (25 mm²), and finger protected (IP20), box terminals complete with self-retaining screws. Alternatively the existing, well established, H263 with 16 mm² terminal capacity will remain available until further notice.

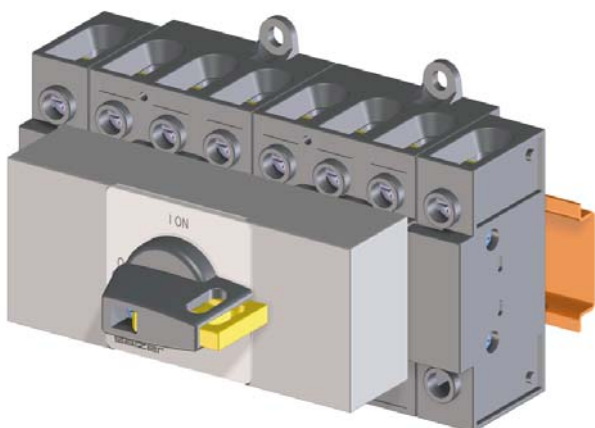

8-pole ON-OFF Switch

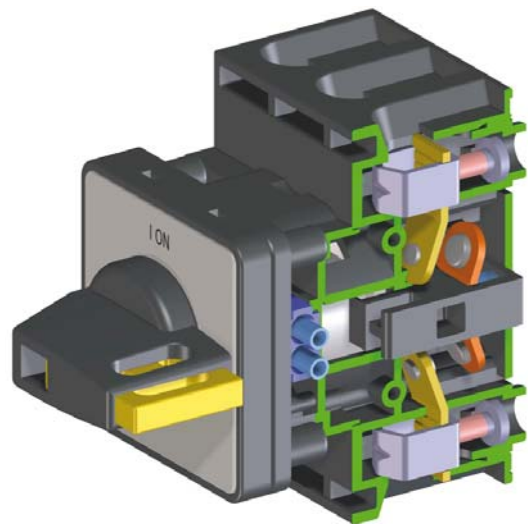

3-pole ON-OFF Switch (cross-sectional)

Within the product line B200 three types are currently available:

- **B240** = 40A operational current to AC-21A, 15 kW operational power to AC-23A with 380-400 V
- **B250** = 50A operational current to AC-21A, 18.5 kW operational power to AC-23A with 380-400 V
- **B263** = 63A operational current to AC-21A, 22 kW operational power to AC-23A with 380-400 V.

As well as both types being compactly designed and of identical mounting size, both provide additional safety by forced opening and positive closing of the contacts.

All mounting form modules and additional accessories for front and base mounting of the mounting size 200 are usable and are combinable with neutral contact module, auxiliary contact modules and N- and PE-terminals.

⇒ Further information on page 12.

Enclosed Switches with insulated enclosure for EMV/EMC application

Connection system for uninterrupted connection of shielded cables

In recent years, the EMV/EMC regulations have gained increasing importance. Sälzer Electric has developed an insulated enclosure complete with a connection system for the uninterrupted connection of shielded/screened cables and provides shielding of the entire system from electro-magnetic interference. This specific product is listed as the Sälzer EMV/EMC enclosure.

The insulated enclosure (175 × 115 × 100 mm H × W × D) is manufactured of polycarbonate with cover interlock in the ON position. In the enclosure is a shielding connection system that accepts the connection of four shielded/screened cables.

The following Disconnect Switches are available in this enclosure:



3-pole Main/Emergency-Off Switch with insulated enclosure for EMV/EMC application

- Types **H216, H220, H226** and **H233** as
 - ⇒ 2-, 3- and 4-pole Main/Emergency-Off Switches or Main Switches
 - ⇒ 6-pole Main/Emergency-Off Switches or Main Switches
 - ⇒ 3- and 4-pole ON-OFF Switches
 - ⇒ 6-pole ON-OFF Switches
 - ⇒ 2- and 3-pole Changeover Switches
- Types **B240, B250** and **B263** as
 - ⇒ 2-, 3- and 4-pole Main/Emergency-Off Switches or Main Switches
 - ⇒ 3- and 4-pole ON-OFF Switches.

⇒ Further information on pages 37, 71, 103 and 126.

Disconnect Switches



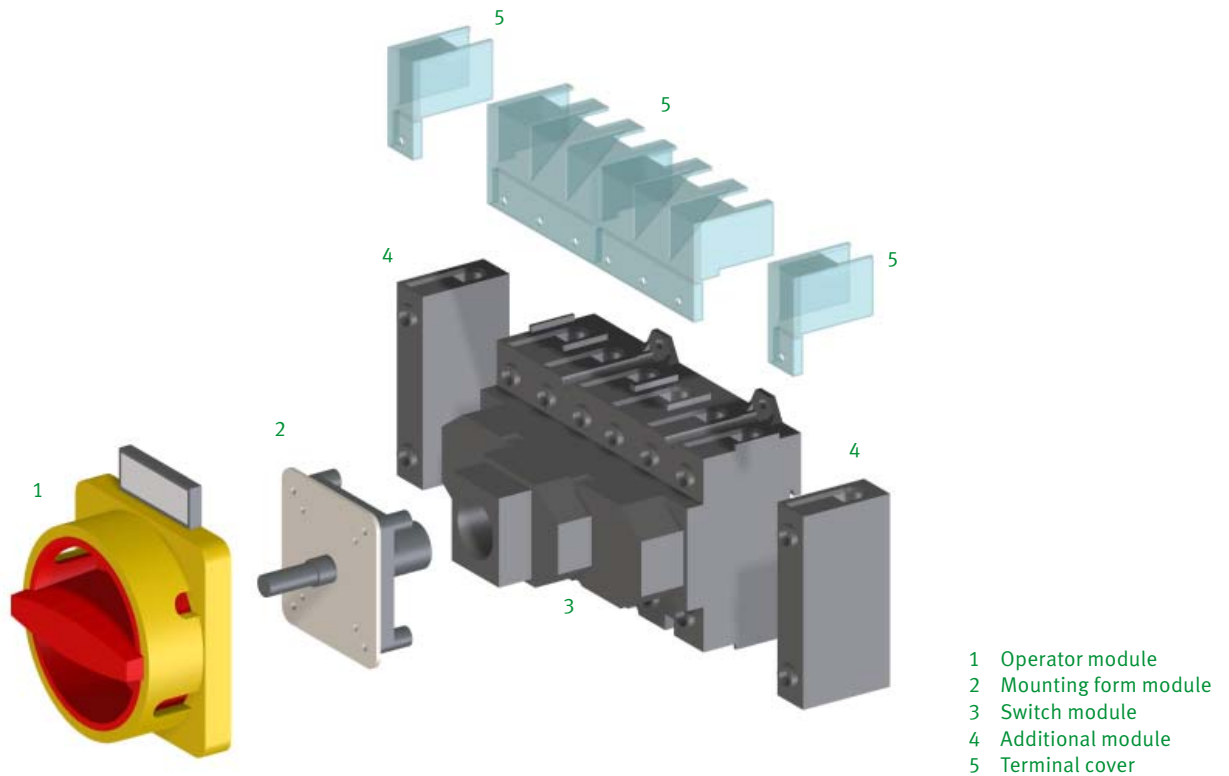

- 1 Operator module
- 2 Mounting form module
- 3 Switch module
- 4 Additional module
- 5 Terminal cover

Disconnect Switches

Safe Switching and Disconnecting

Disconnect Switches from Sälzer Electric are hand-operated switchgear for main circuits with 90° switching angle and are offered as ON-OFF Switches (2, 3, 4, 6 and 8 pole) or as Changeover Switches with centre OFF (2, 3 and 4 pole).

Design and Function

- 90° switching angle
- forced open contacts
- finger protected
(degree of protection up to IP20)
- short-circuit rating
- fulfills the load break requirements up to 690 V and 1000 V
- terminal screws in open position

Applications

Disconnect Switches offer ideal features for their use as:

- ON-OFF Switches
- Main Switches
- Emergency-Off Switches
- Maintenance Switches
- Safety Switches
- Distribution Switches
- Motor Switches

Conformity

Our products are designed, manufactured and tested according to the following standards:

- IEC 60947
- IEC 60204-1
- EN 60947
- EN 60204-1
- cUL 508
- GOST R500 30.3-99

Disconnect Switches

Product overview

Mounting options:



Front Mounting

- Four hole mounting
- Single hole mounting



Base Mounting

- Snap-on mounting
- Four hole mounting



Enclosed Switches

- Insulated enclosure
- Mild steel enclosure
- Stainless steel enclosure

With a broad range of mounting and operator options, Sälzer Electric can provide economical, versatile and reliable solutions!

All products are available
in different versions

Setup of order code number:

The 16 digit order code number for complete switches consists of the three ident numbers for type, switching programme and mounting form:



- the **type** specifies the physical size and power rating of the switch
- the **switching programme** specifies the switching arrangement and the switching angle
- the **mounting form** specifies the mounting, types of handle and optional extras.

In addition to the order code number, each complete switch is assigned a machine readable 13 digit EAN Code.

Ordering example:



Order code number: H216 - 71300 - 214V1

- **Type H216**
for a switch of the product line H200, operational current $I_e = 20 \text{ A}$
- **Switching programme 71300**
for a 3 pole Changeover Switch without auxiliary contacts
- **Mounting form 214V1**
for a front mounting switch with single hole mounting $\varnothing 22.5 \text{ mm}$
and padlockable V-handle (silver/black).

On the individual product pages you will find detailed all possible combinations for the Standard Switching Programmes, hence you will only require the order code number for the complete switch.

Additional switching programmes can be found from page 132 where the new order code number for the switching programme can be identified. Please note that the identification number of the switching programme must now be replaced by the new selection.

Disconnect Switches

Main/Emergency-Off Switches **Front mounting** Four hole mounting

Main/Emergency-Off Switches

- Front mounting switches with four hole mounting
- 3 up to 8 pole
- 20 A up to 315 A
- IP66 / IP55



Switching programme	Rated data (IEC 60947)			Mounting dimension (mm)	Padlock device N-handle yellow/red	Padlock device M-handle yellow/red	Padlockable handle V-handle yellow/red
	Operat. current I_e	Operational power (at 380–440 V)			 IP66	 IP66	 IP66
	AC-21A (A)	AC-23A (kW)	AC-3 (kW)		Order code number	Order code number	Order code number
41300 – 3 pole – without auxiliary contacts 	20	5.5	3.7	36 × 36	H216-41300-033N4	H216-41300-033M4	H216-41300-033V4
	20	5.5	3.7	48 × 48	H216-41300-036N4	H216-41300-036M4	H216-41300-036V4
	25	7.5	5.5	36 × 36	H220-41300-033N4	H220-41300-033M4	H220-41300-033V4
	25	7.5	5.5	48 × 48	H220-41300-036N4	H220-41300-036M4	H220-41300-036V4
	32	11	7.5	36 × 36	H226-41300-033N4	H226-41300-033M4	H226-41300-033V4
	32	11	7.5	48 × 48	H226-41300-036N4	H226-41300-036M4	H226-41300-036V4
	40	15	11	36 × 36	H233-41300-033N4	H233-41300-033M4	H233-41300-033V4
	40	15	11	36 × 36	B240-41300-033N4*	B240-41300-033M4*	B240-41300-033V4*
	40	15	11	48 × 48	H233-41300-036N4	H233-41300-036M4	H233-41300-036V4
	40	15	11	48 × 48	B240-41300-036N4*	B240-41300-036M4*	B240-41300-036V4*
	40	15	11	68 × 68	B240-41300-136N4	B240-41300-136M4	–
	50	18.5	15	36 × 36	B250-41300-033N4	B250-41300-033M4	B250-41300-033V4
	50	18.5	15	48 × 48	B250-41300-036N4	B250-41300-036M4	B250-41300-036V4
	50	18.5	15	68 × 68	B250-41300-136N4	B250-41300-136M4	–
	63	22	18.5	36 × 36	B263-41300-033N4	B263-41300-033M4	B263-41300-033V4
	63	22	18.5	48 × 48	B263-41300-036N4	B263-41300-036M4	B263-41300-036V4
	63	22	18.5	48 × 48	H406-41300-033N4*	H406-41300-033M4*	H406-41300-033V4*
	63	22	18.5	68 × 68	B263-41300-136N4	B263-41300-136M4	–
	63	22	18.5	68 × 68	H406-41300-036N4*	H406-41300-036M4*	–
	80	30	22	48 × 48	H408-41300-033N4	H408-41300-033M4	H408-41300-033V4
80	30	22	68 × 68	H408-41300-036N4	H408-41300-036M4	–	
100	37	30	48 × 48	H410-41300-033N4	H410-41300-033M4	H410-41300-033V4	
100	37	30	68 × 68	H410-41300-036N4	H410-41300-036M4	–	
125	45	37	48 × 48	H412-41300-033N4	H412-41300-033M4	H412-41300-033V4	
125	45	37	68 × 68	H412-41300-036N4	H412-41300-036M4	–	

Rated data (IEC 60947)			Mounting dimension (mm)	Padlock device H-handle yellow/red	
Operat. current I_e	Operational power (at 380–440 V)			 IP55	
AC-21A (A)	AC-23A (kW)	AC-3 (kW)		Order code number	
160	75	45	68 × 68	K616-41300-033H4	
315	132	55	104 × 104	K830-41300-033H4	



* larger terminal capacity, see page 154

Further switching programmes from page 132.

Disconnect Switches

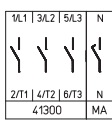

Main/Emergency-Off Switches Front mounting Four hole mounting

Switching programme	Rated data (IEC 60947)			Mounting dimension (mm)	Padlock device N-handle yellow/red	Padlock device M-handle yellow/red	Padlockable handle V-handle yellow/red
	Operat. current I_e	Operational power (at 380–440 V)			 IP66	 IP66	 IP66
	AC-21A (A)	AC-23A (kW)	AC-3 (kW)		Order code number	Order code number	Order code number
41400 – 4 pole – without auxiliary contacts – neutral contact early make/late break 	20	5.5	3.7	36 × 36	H216-41400-033N4	H216-41400-033M4	H216-41400-033V4
	20	5.5	3.7	48 × 48	H216-41400-036N4	H216-41400-036M4	H216-41400-036V4
	25	7.5	5.5	36 × 36	H220-41400-033N4	H220-41400-033M4	H220-41400-033V4
	25	7.5	5.5	48 × 48	H220-41400-036N4	H220-41400-036M4	H220-41400-036V4
	32	11	7.5	36 × 36	H226-41400-033N4	H226-41400-033M4	H226-41400-033V4
	32	11	7.5	48 × 48	H226-41400-036N4	H226-41400-036M4	H226-41400-036V4
	40	15	11	36 × 36	H233-41400-033N4	H233-41400-033M4	H233-41400-033V4
	40	15	11	36 × 36	B240-41400-033N4*	B240-41400-033M4*	B240-41400-033V4*
	40	15	11	48 × 48	H233-41400-036N4	H233-41400-036M4	H233-41400-036V4
	40	15	11	48 × 48	B240-41400-036N4*	B240-41400-036M4*	B240-41400-036V4*
	40	15	11	68 × 68	B240-41400-136N4	B240-41400-136M4	–
	50	18.5	15	36 × 36	B250-41400-033N4	B250-41400-033M4	B250-41400-033V4
	50	18.5	15	48 × 48	B250-41400-036N4	B250-41400-036M4	B250-41400-036V4
	50	18.5	15	68 × 68	B250-41400-136N4	B250-41400-136M4	–
	63	22	18.5	36 × 36	B263-41400-033N4	B263-41400-033M4	B263-41400-033V4
	63	22	18.5	48 × 48	B263-41400-036N4	B263-41400-036M4	B263-41400-036V4
	63	22	18.5	48 × 48	H406-41400-033N4*	H406-41400-033M4*	H406-41400-033V4*
	63	22	18.5	68 × 68	B263-41400-136N4	B263-41400-136M4	–
	63	22	18.5	68 × 68	H406-41400-036N4*	H406-41400-036M4*	–
	80	30	22	48 × 48	H408-41400-033N4	H408-41400-033M4	H408-41400-033V4
80	30	22	68 × 68	H408-41400-036N4	H408-41400-036M4	–	
100	37	30	48 × 48	H410-41400-033N4	H410-41400-033M4	H410-41400-033V4	
100	37	30	68 × 68	H410-41400-036N4	H410-41400-036M4	–	
125	45	37	48 × 48	H412-41400-033N4	H412-41400-033M4	H412-41400-033V4	
125	45	37	68 × 68	H412-41400-036N4	H412-41400-036M4	–	

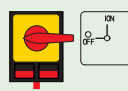

Rated data (IEC 60947)			Mounting dimension (mm)	Padlock device H-handle yellow/red	Order code number
Operat. current I_e	Operational power (at 380–440 V)			 IP55	
AC-21A (A)	AC-23A (kW)	AC-3 (kW)			
160	75	45	68 × 68	K616-41400-033H4	
315	132	55	104 × 104	K830-41400-033H4	

* larger terminal capacity, see page 154

Further switching programmes from page 132.

Disconnect Switches

Main/Emergency-Off Switches Front mounting Four hole mounting

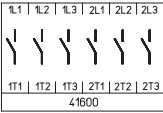
Switching programme	Rated data (IEC 60947)			Mounting dimension (mm)	Padlock device N-handle yellow/red	Padlock device M-handle yellow/red	Padlockable handle V-handle yellow/red
	Operat. current I_e	Operational power (at 380–440 V)			 IP66	 IP66	 IP66
		AC-21A (A)	AC-23A (kW)		AC-3 (kW)	Order code number	Order code number
41600 – 6 pole – without auxiliary contacts 	20	5.5	3.7	36 × 36	H216-41600-033N4	H216-41600-033M4	–
	20	5.5	3.7	48 × 48	H216-41600-036N4	H216-41600-036M4	H216-41600-036V4
	20	5.5	3.7	68 × 68	H216-41600-136N4	H216-41600-136M4	–
	25	7.5	5.5	36 × 36	H220-41600-033N4	H220-41600-033M4	–
	25	7.5	5.5	48 × 48	H220-41600-036N4	H220-41600-036M4	H220-41600-036V4
	25	7.5	7.5	68 × 68	H220-41600-136N4	H220-41600-136M4	–
	32	11	7.5	36 × 36	H226-41600-033N4	H226-41600-033M4	–
	32	11	7.5	48 × 48	H226-41600-036N4	H226-41600-036M4	H226-41600-036V4
	32	11	7.5	68 × 68	H226-41600-136N4	H226-41600-136M4	–
	40	15	11	36 × 36	H233-41600-033N4	H233-41600-033M4	–
	40	15	11	36 × 36	B240-41600-033N4*	B240-41600-033M4*	–
	40	15	11	48 × 48	H233-41600-036N4	H233-41600-036M4	H233-41600-036V4
	40	15	11	48 × 48	B240-41600-036N4*	B240-41600-036M4*	B240-41600-036V4
	40	15	11	68 × 68	H233-41600-136N4	H233-41600-136M4	–
	40	15	11	68 × 68	B240-41600-136N4*	B240-41600-136M4*	–
	50	18.5	15	36 × 36	B250-41600-033N4	B250-41600-033M4	–
	50	18.5	15	48 × 48	B250-41600-036N4	B250-41600-036M4	B250-41600-036V4
	50	18.5	15	68 × 68	B250-41600-136N4	B250-41600-136M4	–
	63	22	18.5	36 × 36	B263-41600-033N4	B263-41600-033M4	–
	63	22	18.5	48 × 48	B263-41600-036N4	B263-41600-036M4	B263-41600-036V4
	63	22	18.5	48 × 48	H406-41600-033N4*	H406-41600-033M4*	H406-41600-033V4*
	63	22	18.5	68 × 68	B263-41600-136N4	B263-41600-136M4	–
	63	22	18.5	68 × 68	H406-41600-036N4*	H406-41600-036M4*	–
	80	30	22	48 × 48	H408-41600-033N4	H408-41600-033M4	H408-41600-033V4
80	30	22	68 × 68	H408-41600-036N4	H408-41600-036M4	–	
100	37	30	48 × 48	H410-41600-033N4	H410-41600-033M4	H410-41600-033V4	
100	37	30	68 × 68	H410-41600-036N4	H410-41600-036M4	–	
125	45	37	48 × 48	H412-41600-033N4	H412-41600-033M4	H412-41600-033V4	
125	45	37	68 × 68	H412-41600-036N4	H412-41600-036M4	–	

Rated data (IEC 60947)			Mounting dimension (mm)	Padlock device H-handle yellow/red
Operat. current I_e	Operational power (at 380–440 V)			 IP55
	AC-21A (A)	AC-23A (kW)	AC-3 (kW)	Order code number
160	75	45	68 × 68	K616-41600-033H4
315	132	55	104 × 104	K830-41600-033H4



* larger terminal capacity, see page 154

Further switching programmes from page 132.

Disconnect Switches

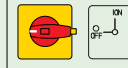
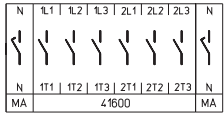

Main/Emergency-Off Switches Front mounting Four hole mounting

Switching programme	Rated data (IEC 60947)			Mounting dimension (mm)	Padlock device N-handle yellow/red	Padlock device M-handle yellow/red	Padlockable handle V-handle yellow/red
	Operat. current I_e	Operational power (at 380–440 V)			 IP66	 IP66	 IP66
	AC-21A (A)	AC-23A (kW)	AC-3 (kW)		Order code number	Order code number	Order code number
41800 – 8 pole – without auxiliary contacts – 2 neutral contacts early make/late break 	20	5.5	3.7	36 × 36	H216-41800-033N4	H216-41800-033M4	–
	20	5.5	3.7	48 × 48	H216-41800-036N4	H216-41800-036M4	H216-41800-036V4
	20	5.5	3.7	68 × 68	H216-41800-136N4	H216-41800-136M4	–
	25	7.5	5.5	36 × 36	H220-41800-033N4	H220-41800-033M4	–
	25	7.5	5.5	48 × 48	H220-41800-036N4	H220-41800-036M4	H220-41800-036V4
	25	7.5	5.5	68 × 68	H220-41800-136N4	H220-41800-136M4	–
	32	11	7.5	36 × 36	H226-41800-033N4	H226-41800-033M4	–
	32	11	7.5	48 × 48	H226-41800-036N4	H226-41800-036M4	H226-41800-036V4
	32	11	7.5	68 × 68	H226-41800-136N4	H226-41800-136M4	–
	40	15	11	36 × 36	H233-41800-033N4	H233-41800-033M4	–
	40	15	11	36 × 36	B240-41800-033N4*	B240-41800-033M4*	–
	40	15	11	48 × 48	H233-41800-036N4	H233-41800-036M4	H233-41800-036V4
	40	15	11	48 × 48	B240-41800-036N4*	B240-41800-036M4*	B240-41800-036V4*
	40	15	11	68 × 68	H233-41800-136N4	H233-41800-136M4	–
	40	15	11	68 × 68	B240-41800-136N4*	B240-41800-136M4*	–
	50	18.5	15	36 × 36	B250-41800-033N4	B250-41800-033M4	–
	50	18.5	15	48 × 48	B250-41800-036N4	B250-41800-036M4	B250-41800-036V4
	50	18.5	15	68 × 68	B250-41800-136N4	B250-41800-136M4	–
	63	22	18.5	36 × 36	B263-41800-033N4	B263-41800-033M4	–
	63	22	18.5	48 × 48	B263-41800-036N4	B263-41800-036M4	B263-41800-036V4
63	22	18.5	48 × 48	H406-41800-033N4*	H406-41800-033M4*	H406-41800-033V4*	
63	22	18.5	68 × 68	B263-41800-136N4	B263-41800-136M4	–	
63	22	18.5	68 × 68	H406-41800-036N4*	H406-41800-036M4*	–	
80	30	22	48 × 48	H408-41800-033N4	H408-41800-033M4	H408-41800-033V4	
80	30	22	68 × 68	H408-41800-036N4	H408-41800-036M4	–	
100	37	30	48 × 48	H410-41800-033N4	H410-41800-033M4	H410-41800-033V4	
100	37	30	68 × 68	H410-41800-036N4	H410-41800-036M4	–	
125	45	37	48 × 48	H412-41800-033N4	H412-41800-033M4	H412-41800-033V4	
125	45	37	68 × 68	H412-41800-036N4	H412-41800-036M4	–	

Rated data (IEC 60947)			Mounting dimension (mm)	Padlock device H-handle yellow/red
Operat. current I_e	Operational power (at 380–440 V)			 IP55
AC-21A (A)	AC-23A (kW)	AC-3 (kW)		Order code number
160	75	45	68 × 68	K616-41800-033H4
315	132	55	104 × 104	K830-41800-033H4

* larger terminal capacity, see page 154

Further switching programmes from page 132.

Disconnect Switches

Main/Emergency-Off Switches **Front mounting** Four hole mounting

Dimensions in mm:

Setup of order code number

Type	Switching progr.	Mtg. form
H216	41800	036N4
Order code no.	H216-41800-036N4	

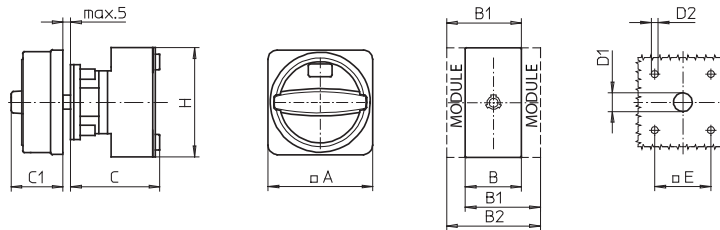

Switching programmes 3 and 4 pole

Types H216 / H220 / H226 / H233:

Mtg. form	A	B	B1	B2	C	C1	D1	D2	E	H
033M4	67	36	48	60	58	38	15	4.5	36	70
033N4	67	36	48	60	58	33	15	4.5	36	70
033V4	48	36	48	60	58	32	12	4.5	36	70
036M4	67	36	48	60	58	38	15	5	48	70
036N4	67	36	48	60	58	33	15	5	48	70
036V4	64	36	48	60	58	39	15	5	48	70

Types B240 / B250 / B263:

Mtg. form	A	B	B1	B2	C	C1	D1	D2	E	H
033M4	67	50	69	88	58	38	15	4.5	36	72
033N4	67	50	69	88	58	33	15	4.5	36	72
033V4	48	50	69	88	58	32	12	4.5	36	72
036M4	67	50	69	88	58	38	15	5	48	72
036N4	67	50	69	88	58	33	15	5	48	72
036V4	64	50	69	88	58	39	15	5	48	72
136M4	88	50	69	88	58	50	15	5.5	68	72
136N4	88	50	69	88	58	45	15	5.5	68	72

Types H406 / H408 / H410 / H412:

Mtg. form	A	B	B1	B2	C	C1	D1	D2	E	H
033M4	88	70	89	108	73	50	15	5	48	80
033N4	88	70	89	108	73	45	15	5	48	80
033V4	64	70	89	108	73	39	15	5	48	80
036M4	88	70	89	108	73	50	15	5.5	68	80
036N4	88	70	89	108	73	45	15	5.5	68	80

Switching programmes 6 and 8 pole

Types H216 / H220 / H226 / H233:

Mtg. form	A	B	B1	B2	C	C1	D1	D2	E	H
033M4	67	72	84	96	66	38	15	4.5	36	70
033N4	67	72	84	96	66	33	15	4.5	36	70
036M4	67	72	84	96	66	38	15	5	48	70
036N4	67	72	84	96	66	33	15	5	48	70
036V4	64	72	84	96	66	39	15	5	48	70
136M4	88	72	84	96	66	38	15	5.5	68	70
136N4	88	72	84	96	66	33	15	5.5	68	70

Types B240 / B250 / B263:

Mtg. form	A	B	B1	B2	C	C1	D1	D2	E	H
033M4	67	100	119	138	70	38	15	4.5	36	72
033N4	67	100	119	138	70	33	15	4.5	36	72
036M4	67	100	119	138	70	38	15	5	48	72
036N4	67	100	119	138	70	33	15	5	48	72
036V4	64	100	119	138	70	39	15	5	48	72
136M4	88	100	119	138	70	50	15	5.5	68	72
136N4	88	100	119	138	70	45	15	5.5	68	72

Types H406 / H408 / H410 / H412:

Mtg. form	A	B	B1	B2	C	C1	D1	D2	E	H
033M4	88	140	159	178	86	50	15	5	48	80
033N4	88	140	159	178	86	45	15	5	48	80
033V4	64	140	159	178	86	39	15	5	48	80
036M4	88	140	159	178	86	50	15	5.5	68	80
036N4	88	140	159	178	86	45	15	5.5	68	80

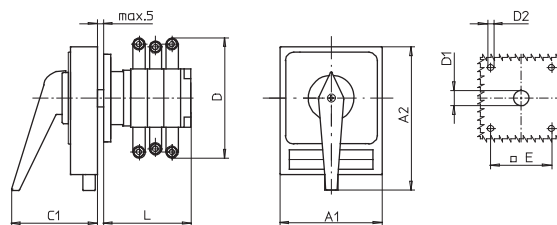

Types K616 / K830:

Type	Mtg. form	Switching progr.	A1	A2	C1	D*	D1	D2	E	L
K616	033H4	41300	98	142	83	150	20	5.5	68	104
K616	033H4	41400	98	142	83	150	20	5.5	68	104
K830	033H4	41300	130	178	93	210	20	5.5	104	125
K830	033H4	41400	130	178	93	210	20	5.5	104	125

Types K616 / K830:

Type	Mtg. form	Switching progr.	A1	A2	C1	D*	D1	D2	E	L
K616	033H4	41600	98	142	83	150	20	5.5	68	136
K616	033H4	41800	98	142	83	150	20	5.5	68	168
K830	033H4	41600	130	178	93	210	20	5.5	104	161
K830	033H4	41800	130	178	93	210	20	5.5	104	197



Further switching programmes and corresponding dimensions for types K on request.

* terminal lugs included

Main/Emergency-Off Switches

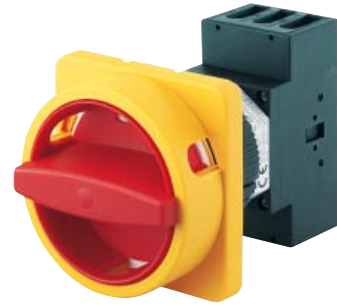
- Front mounting switches with single hole mounting
- 3 up to 8 pole
- 20 A up to 63 A
- IP66



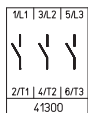
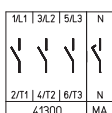

Switching programme	Rated data (IEC 60947)			Mounting dimension (mm)	Padlock device N-handle yellow/red	Padlock device M-handle yellow/red	Padlockable handle V-handle yellow/red
	Operat. current I_e	Operational power (at 380–440 V)			 IP66	 IP66	 IP66
	AC-21A (A)	AC-23A (kW)	AC-3 (kW)		Order code number	Order code number	Order code number
41300 – 3 pole – without auxiliary contacts 	20	5.5	3.7	∅ 22.5	H216-41300-206N4	H216-41300-206M4	H216-41300-206V4
	20	5.5	3.7	∅ 30.5	H216-41300-216N4	H216-41300-216M4	H216-41300-216V4
	25	7.5	5.5	∅ 22.5	H220-41300-206N4	H220-41300-206M4	H220-41300-206V4
	25	7.5	5.5	∅ 30.5	H220-41300-216N4	H220-41300-216M4	H220-41300-216V4
	32	11	7.5	∅ 22.5	H226-41300-206N4	H226-41300-206M4	H226-41300-206V4
	32	11	7.5	∅ 30.5	H226-41300-216N4	H226-41300-216M4	H226-41300-216V4
	40	15	11	∅ 22.5	H233-41300-206N4	H233-41300-206M4	H233-41300-206V4
	40	15	11	∅ 22.5	B240-41300-206N4*	B240-41300-206M4*	B240-41300-206V4*
	40	15	11	∅ 30.5	H233-41300-216N4	H233-41300-216M4	H233-41300-216V4
	40	15	11	∅ 30.5	B240-41300-216N4*	B240-41300-216M4*	B240-41300-216V4*
	50	18.5	15	∅ 22.5	B250-41300-206N4	B250-41300-206M4	B250-41300-206V4
	50	18.5	15	∅ 30.5	B250-41300-216N4	B250-41300-216M4	B250-41300-216V4
	63	22	18.5	∅ 22.5	B263-41300-206N4	B263-41300-206M4	B263-41300-206V4
	63	22	18.5	∅ 30.5	B263-41300-216N4	B263-41300-216M4	B263-41300-216V4
41400 – 4 pole – without auxiliary contacts – neutral contact early make/late break 	20	5.5	3.7	∅ 22.5	H216-41400-206N4	H216-41400-206M4	H216-41400-206V4
	20	5.5	3.7	∅ 30.5	H216-41400-216N4	H216-41400-216M4	H216-41400-216V4
	25	7.5	5.5	∅ 22.5	H220-41400-206N4	H220-41400-206M4	H220-41400-206V4
	25	7.5	5.5	∅ 30.5	H220-41400-216N4	H220-41400-216M4	H220-41400-216V4
	32	11	7.5	∅ 22.5	H226-41400-206N4	H226-41400-206M4	H226-41400-206V4
	32	11	7.5	∅ 30.5	H226-41400-216N4	H226-41400-216M4	H226-41400-216V4
	40	15	11	∅ 22.5	H233-41400-206N4	H233-41400-206M4	H233-41400-206V4
	40	15	11	∅ 22.5	B240-41400-206N4*	B240-41400-206M4*	B240-41400-206V4*
	40	15	11	∅ 30.5	H233-41400-216N4	H233-41400-216M4	H233-41400-216V4
	40	15	11	∅ 30.5	B240-41400-216N4*	B240-41400-216M4*	B240-41400-216V4*
	50	18.5	15	∅ 22.5	B250-41400-206N4	B250-41400-206M4	B250-41400-206V4
	50	18.5	15	∅ 30.5	B250-41400-216N4	B250-41400-216M4	B250-41400-216V4
	63	22	18.5	∅ 22.5	B263-41400-206N4	B263-41400-206M4	B263-41400-206V4
	63	22	18.5	∅ 30.5	B263-41400-216N4	B263-41400-216M4	B263-41400-216V4

* larger terminal capacity, see page 154

Further switching programmes from page 132.

Disconnect Switches

Main/Emergency-Off Switches **Front mounting** Single hole mounting

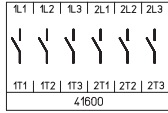
Switching programme	Rated data (IEC 60947)			Mounting dimension (mm)	Padlock device N-handle yellow/red	Padlock device M-handle yellow/red	Padlockable handle V-handle yellow/red
	Operat. current I_e	Operational power at (380–440 V)			 IP66	 IP66	 IP66
	AC-21A (A)	AC-23A (kW)	AC-3 (kW)		Order code number	Order code number	Order code number
41600 – 6 pole – without auxiliary contacts 	20	5.5	3.7	∅ 22.5	H216-41600-206N4	H216-41600-206M4	–
	20	5.5	3.7	∅ 30.5	H216-41600-216N4	H216-41600-216M4	H216-41600-216V4
	25	7.5	5.5	∅ 22.5	H220-41600-206N4	H220-41600-206M4	–
	25	7.5	5.5	∅ 30.5	H220-41600-216N4	H220-41600-216M4	H220-41600-216V4
	32	11	7.5	∅ 22.5	H226-41600-206N4	H226-41600-206M4	–
	32	11	7.5	∅ 30.5	H226-41600-216N4	H226-41600-216M4	H226-41600-216V4
	40	15	11	∅ 22.5	H233-41600-206N4	H233-41600-206M4	–
	40	15	11	∅ 30.5	H233-41600-216N4	H233-41600-216M4	H233-41600-216V4

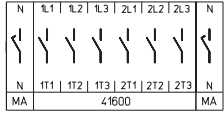
41800 – 8 pole – without auxiliary contacts – 2 neutral contacts early make/late break 	20	5.5	3.7	∅ 22.5	H216-41800-206N4	H216-41800-206M4	–
	20	5.5	3.7	∅ 30.5	H216-41800-216N4	H216-41800-216M4	H216-41800-216V4
	25	7.5	5.5	∅ 22.5	H220-41800-206N4	H220-41800-206M4	–
	25	7.5	5.5	∅ 30.5	H220-41800-216N4	H220-41800-216M4	H220-41800-216V4
	32	11	7.5	∅ 22.5	H226-41800-206N4	H226-41800-206M4	–
	32	11	7.5	∅ 30.5	H226-41800-216N4	H226-41800-216M4	H226-41800-216V4
	40	15	11	∅ 22.5	H233-41800-206N4	H233-41800-206M4	–
	40	15	11	∅ 30.5	H233-41800-216N4	H233-41800-216M4	H233-41800-216V4

Further switching programmes from page 132.

Dimensions in mm:

Setup of order code number		
Type	Switching progr.	Mtg. form
H226	41300	206N4
Order code no.	H226-41300-206N4	

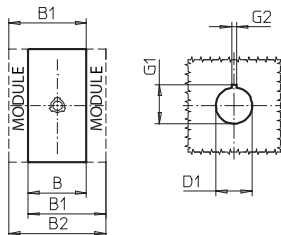
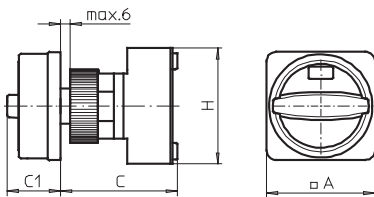

Switching programmes 3 and 4 pole

Types H216 / H220 / H226 / H233:

Mtg. form	A	B	B1	B2	C	C1	D1	G1	G2	H
206M4	67	36	48	60	75	38	22.5	24.2	3.2	70
206N4	67	36	48	60	75	33	22.5	24.2	3.2	70
206V4	48	36	48	60	75	32	22.5	24.2	3.2	70
216M4	67	36	48	60	75	38	30.5	33	4.8	70
216N4	67	36	48	60	75	33	30.5	33	4.8	70
216V4	64	36	48	60	75	39	30.5	33	4.8	70

Types B240 / B250 / B263:

Mtg. form	A	B	B1	B2	C	C1	D1	G1	G2	H
206M4	67	50	69	88	75	38	22.5	24.2	3.2	72
206N4	67	50	69	88	75	33	22.5	24.2	3.2	72
206V4	48	50	69	88	75	32	22.5	24.2	3.2	72
216M4	67	50	69	88	75	38	30.5	33	4.8	72
216N4	67	50	69	88	75	33	30.5	33	4.8	72
216V4	64	50	69	88	75	39	30.5	33	4.8	72

Switching programmes 6 and 8 pole



Types H216 / H220 / H226 / H233:

Mtg. form	A	B	B1	B2	C	C1	D1	G1	G2	H
206M4	67	72	84	96	83	38	22.5	24.2	3.2	70
206N4	67	72	84	96	83	33	22.5	24.2	3.2	70
216M4	67	72	84	96	83	38	30.5	33	4.8	70
216N4	67	72	84	96	83	33	30.5	33	4.8	70
216V4	64	72	84	96	83	39	30.5	33	4.8	70

Main/Emergency-Off Switches

- Base mounting switches with snap-on mounting
- for DIN rail
- 3 up to 8 pole
- 20 A up to 125 A
- IP30

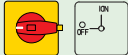

Switching programme	Rated data (IEC 60947)			Escutcheon dimension for 45 mm aperture in Panel/Distribution boards (H × W) (mm)	Padlockable handle V-handle yellow/red  IP30	Order code number
	Operat. current I _e (A)	Operational power (at 380–440 V) (kW)	AC-3 (kW)			
41300 – 3 pole – without auxiliary contacts 	20	5.5	3.7	45 × 48	H216-41300-026V4	
	20	5.5	3.7	45 × 60	H216-41300-126V4	
	25	7.5	5.5	45 × 48	H220-41300-026V4	
	25	7.5	5.5	45 × 60	H220-41300-126V4	
	32	11	7.5	45 × 48	H226-41300-026V4	
	32	11	7.5	45 × 60	H226-41300-126V4	
	40	15	11	45 × 48	H233-41300-026V4	
	40	15	11	45 × 52.5	B240-41300-026V4*	
	40	15	11	45 × 60	H233-41300-126V4	
	50	18.5	15	45 × 52.5	B250-41300-026V4	
	63	22	18.5	45 × 52.5	B263-41300-026V4	
	63	22	18.5	45 × 72	H406-41300-126V4*	
	80	30	22	45 × 72	H408-41300-126V4	
	100	37	30	45 × 72	H410-41300-126V4	
125	45	37	45 × 72	H412-41300-126V4		
41400 – 4 pole – without auxiliary contacts – neutral contact early make/late break 	20	5.5	3.7	45 × 48	H216-41400-026V4	
	20	5.5	3.7	45 × 60	H216-41400-126V4	
	25	7.5	5.5	45 × 48	H220-41400-026V4	
	25	7.5	5.5	45 × 60	H220-41400-126V4	
	32	11	7.5	45 × 48	H226-41400-026V4	
	32	11	7.5	45 × 60	H226-41400-126V4	
	40	15	11	45 × 48	H233-41400-026V4	
	40	15	11	45 × 52.5	B240-41400-026V4*	
	40	15	11	45 × 60	H233-41400-126V4	
	50	18.5	15	45 × 52.5	B250-41400-026V4	
	63	22	18.5	45 × 52.5	B263-41400-026V4	
	63	22	18.5	45 × 72	H406-41400-126V4*	
	80	30	22	45 × 72	H408-41400-126V4	
	100	37	30	45 × 72	H410-41400-126V4	
125	45	37	45 × 72	H412-41400-126V4		

* larger terminal capacity, see page 154

Further switching programmes from page 132.

Disconnect Switches

Main/Emergency-Off Switches **Base mounting** Snap-on mounting for DIN rail

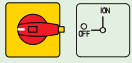
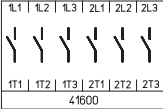

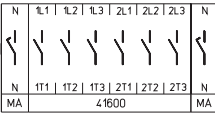
Switching programme	Rated data (IEC 60947)			Escutcheon dimension for 45 mm aperture in Panel/Distribution boards (H × W) (mm)	Padlockable handle V-handle yellow/red  IP30	Order code number
	Operat. current I _e	Operational power (at 380–440 V)				
	AC-21A (A)	AC-23A (kW)	AC-3 (kW)			
41600 – 6 pole – without auxiliary contacts 	20	5.5	3.7	45 × 76	H216-41600-026V4	
	25	7.5	5.5	45 × 76	H220-41600-026V4	
	32	11	7.5	45 × 76	H226-41600-026V4	
	40	15	11	45 × 76	H233-41600-026V4	
	40	15	11	45 × 105	B240-41600-026V4*	
	50	18.5	15	45 × 105	B250-41600-026V4	
	63	22	18.5	45 × 105	B263-41600-026V4	
	63	22	18.5	45 × 72	H406-41600-126V4*	
	80	30	22	45 × 72	H408-41600-126V4	
	100	37	30	45 × 72	H410-41600-126V4	
	125	45	37	45 × 72	H412-41600-126V4	

41800 – 8 pole – without auxiliary contacts – 2 neutral contacts early make/late break 	20	5.5	3.7	45 × 76	H216-41800-026V4	
	25	7.5	5.5	45 × 76	H220-41800-026V4	
	32	11	7.5	45 × 76	H226-41800-026V4	
	40	15	11	45 × 76	H233-41800-026V4	
	40	15	11	45 × 105	B240-41800-026V4*	
	50	18.5	15	45 × 105	B250-41800-026V4	
	63	22	18.5	45 × 105	B263-41800-026V4	
	63	22	18.5	45 × 72	H406-41800-126V4*	
	80	30	22	45 × 72	H408-41800-126V4	
	100	37	30	45 × 72	H410-41800-126V4	
	125	45	37	45 × 72	H412-41800-126V4	

* larger terminal capacity, see page 154
Further switching programmes from page 132.

Dimensions in mm:

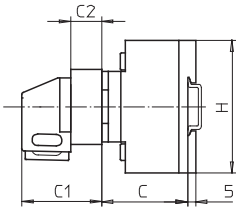
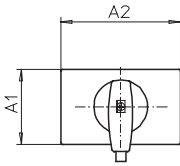
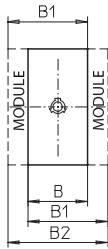
Setup of order code number		
Type	Switching progr.	Mtg. form
H216	41300	026V4
Order code no. H216-41300-026V4		

Switching programmes 3 and 4 pole

Types H216 / H220 / H226 / H233:

Mtg. form	A1	A2	B	B1	B2	C	C1	C2	H
026V4	45	48	36	48	60	38	45	18.5	70
126V4	45	60	36	48	60	38	45	18.5	70

Types B240 / B250 / B263:

Mtg. form	A1	A2	B	B1	B2	C	C1	C2	H
026V4	45	52.5	50	69	88	38	45	18.5	72

Types H406 / H408 / H410 / H412:

Mtg. form	A1	A2	B	B1	B2	C	C1	C2	H
126V4	45	72	70	89	108	55	48	16	80

Switching programmes 6 and 8 pole

Types H216 / H220 / H226 / H233:

Mtg. form	A1	A2	B	B1	B2	C	C1	C2	H
026V4	45	76	72	84	96	40	51.5	25.5	70

Types B240 / B250 / B263:

Mtg. form	A1	A2	B	B1	B2	C	C1	C2	H
026V4	45	105	100	119	138	40	51.5	25.5	72

Types H406 / H408 / H410 / H412:

Mtg. form	A1	A2	B	B1	B2	C	C1	C2	H
126V4	45	72	140	159	178	67	48	16	80

Main/Emergency-Off Switches

- Base mounting switches with snap-on mounting
- Door interlock
- 3 up to 8 pole
- 20 A up to 125 A
- **IP66**
- with modular or metal shaft extension
- single or four hole front mounting



Base mounting switches with snap-on mounting and door interlock are offered with two different extensions:

1. Switches with **modular shaft extensions** can be extended with additional modules (modular shaft extensions see picture) which can be fixed to achieve different required mounting depths – dimension C. The modules are detailed on page 145.

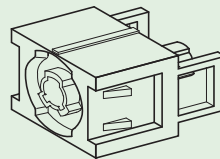
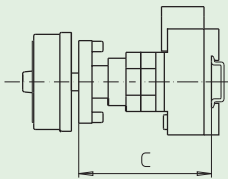

AVC2/AVC4
Modular shaft extension

2. For switches with **metal shaft extension** the metal shaft is not included in the scope of delivery and has to be ordered separately. Data for mounting dimension C and for the different types of metal shafts can be found on page 146.

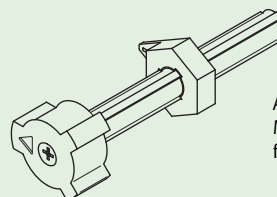
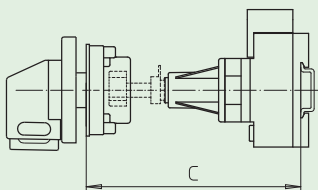

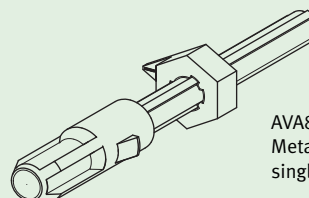
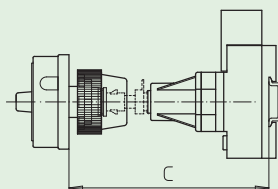

AVB8
Metal shaft extension for
four hole front mounting



AVA8
Metal shaft extension for
single hole front mounting

Disconnect Switches

Main/Emergency-Off Switches **Base mounting** Snap-on mounting with door interlock

Switching programme	Rated data (IEC 60947)			Mounting dimension (front) (mm)	Padlock device N-handle yellow/red	Padlock device M-handle yellow/red	Padlockable handle V-handle yellow/red
	Operat. current I_e	Operational power (at 380–440 V)					
	AC-21A (A)	AC-23A (kW)	AC-3 (kW)		IP66	IP66	IP66
					Order code number	Order code number	Order code number

41300
– 3 pole
– without auxiliary contacts



Modular shaft extension:

➔ Modular shaft extensions see page 145!

20	25	32	40	50	63	80	100	125	36 x 36	48 x 48	36 x 36	48 x 48	36 x 36	48 x 48	36 x 36	48 x 48	36 x 36	48 x 48	36 x 36	48 x 48
20	25	32	40	50	63	80	100	125	36 x 36	48 x 48	H216-41300-234N4	H216-41300-238N4	H220-41300-234N4	H220-41300-238N4	H226-41300-234N4	H226-41300-238N4	H233-41300-234N4	H233-41300-238N4	B240-41300-234N4*	B240-41300-238N4*
											H216-41300-234M4	H216-41300-238M4	H220-41300-234M4	H220-41300-238M4	H226-41300-234M4	H226-41300-238M4	H233-41300-234M4	H233-41300-238M4	B240-41300-234M4*	B240-41300-238M4*
											H216-41300-234V4	H216-41300-238V4	H220-41300-234V4	H220-41300-238V4	H226-41300-234V4	H226-41300-238V4	H233-41300-234V4	H233-41300-238V4	B240-41300-234V4*	B240-41300-238V4*



Metal shaft extension:

➔ Metal shaft is not included. Please order separately, see page 146!

20	25	32	40	50	63	80	100	125	36 x 36	48 x 48	36 x 36	48 x 48	36 x 36	48 x 48	36 x 36	48 x 48	36 x 36	48 x 48	36 x 36	48 x 48
20	25	32	40	50	63	80	100	125	36 x 36	48 x 48	H216-41300-483N4	H216-41300-484N4	H220-41300-483N4	H220-41300-484N4	H226-41300-483N4	H226-41300-484N4	H233-41300-483N4	H233-41300-484N4	B240-41300-483N4*	B240-41300-484N4*
											H216-41300-483M4	H216-41300-484M4	H220-41300-483M4	H220-41300-484M4	H226-41300-483M4	H226-41300-484M4	H233-41300-483M4	H233-41300-484M4	B240-41300-483M4*	B240-41300-484M4*
											H216-41300-483V4	H216-41300-484V4	H220-41300-483V4	H220-41300-484V4	H226-41300-483V4	H226-41300-484V4	H233-41300-483V4	H233-41300-484V4	B240-41300-483V4*	B240-41300-484V4*

* larger terminal capacity, see page 154

Further switching programmes from page 132.

Switching programme	Rated data (IEC 60947)			Mounting dimension (front) (mm)	Padlock device N-handle yellow/red	Padlock device M-handle yellow/red	Padlockable handle V-handle yellow/red
	Operat. current I_e	Operational power (at 380–440 V)			 IP66	 IP66	 IP66
	AC-21A (A)	AC-23A (kW)	AC-3 (kW)		Order code number	Order code number	Order code number

41400

- 4 pole
- without auxiliary contacts
- neutral contact
- early make/late break

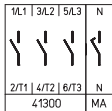

Modular shaft extension:

→ Modular shaft extensions see page 145!

20	25	32	40	50	63	80	100	125	36 × 36	48 × 48	36 × 36	48 × 48	36 × 36	48 × 48	36 × 36	48 × 48	36 × 36	48 × 48
									H216-41400-234N4	H216-41400-238N4	H216-41400-234M4	H216-41400-238M4	H216-41400-234V4	H216-41400-238V4				
									H220-41400-234N4	H220-41400-238N4	H220-41400-234M4	H220-41400-238M4	H220-41400-234V4	H220-41400-238V4				
									H226-41400-234N4	H226-41400-238N4	H226-41400-234M4	H226-41400-238M4	H226-41400-234V4	H226-41400-238V4				
									H233-41400-234N4	H233-41400-238N4	H233-41400-234M4	H233-41400-238M4	H233-41400-234V4	H233-41400-238V4				
									B240-41400-234N4*	B240-41400-238N4*	B240-41400-234M4*	B240-41400-238M4*	B240-41400-234V4*	B240-41400-238V4*				
									H250-41400-234N4	H250-41400-238N4	H250-41400-234M4	H250-41400-238M4	H250-41400-234V4	H250-41400-238V4				
									B263-41400-234N4	B263-41400-238N4	B263-41400-234M4	B263-41400-238M4	B263-41400-234V4	B263-41400-238V4				
									H406-41400-234N4*	H406-41400-238N4*	H406-41400-234M4*	H406-41400-238M4*	H406-41400-234V4*	H406-41400-238V4*				
									H408-41400-234N4	H408-41400-238N4	H408-41400-234M4	H408-41400-238M4	H408-41400-234V4	H408-41400-238V4				
									H410-41400-234N4	H410-41400-238N4	H410-41400-234M4	H410-41400-238M4	H410-41400-234V4	H410-41400-238V4				
									H412-41400-234N4	H412-41400-238N4	H412-41400-234M4	H412-41400-238M4	H412-41400-234V4	H412-41400-238V4				

Metal shaft extension:

→ Metal shaft is not included. Please order separately, see page 146!



20	25	32	40	50	63	80	100	125	36 × 36	48 × 48	∅ 22.5	36 × 36	48 × 48	∅ 22.5	36 × 36	48 × 48	∅ 22.5	36 × 36	48 × 48	∅ 22.5	
									H216-41400-483N4	H216-41400-484N4	H216-41400-281N4	H216-41400-483M4	H216-41400-484M4	H216-41400-281M4	H216-41400-483V4	H216-41400-484V4	H216-41400-281V4				
									H220-41400-483N4	H220-41400-484N4	H220-41400-281N4	H220-41400-483M4	H220-41400-484M4	H220-41400-281M4	H220-41400-483V4	H220-41400-484V4	H220-41400-281V4				
									H226-41400-483N4	H226-41400-484N4	H226-41400-281N4	H226-41400-483M4	H226-41400-484M4	H226-41400-281M4	H226-41400-483V4	H226-41400-484V4	H226-41400-281V4				
									H233-41400-483N4	H233-41400-484N4	H233-41400-281N4	H233-41400-483M4	H233-41400-484M4	H233-41400-281M4	H233-41400-483V4	H233-41400-484V4	H233-41400-281V4				
									B240-41400-483N4*	B240-41400-484N4*	B240-41400-281N4*	B240-41400-483M4*	B240-41400-484M4*	B240-41400-281M4*	B240-41400-483V4*	B240-41400-484V4*	B240-41400-281V4*				
									H250-41400-483N4	H250-41400-484N4	H250-41400-281N4	H250-41400-483M4	H250-41400-484M4	H250-41400-281M4	H250-41400-483V4	H250-41400-484V4	H250-41400-281V4				
									B263-41400-483N4	B263-41400-484N4	B263-41400-281N4	B263-41400-483M4	B263-41400-484M4	B263-41400-281M4	B263-41400-483V4	B263-41400-484V4	B263-41400-281V4				
									H406-41400-483N4*	H406-41400-484N4*	H406-41400-281N4*	H406-41400-483M4*	H406-41400-484M4*	H406-41400-281M4*	H406-41400-483V4*	H406-41400-484V4*	H406-41400-281V4*				
									H408-41400-483N4	H408-41400-484N4	H408-41400-281N4	H408-41400-483M4	H408-41400-484M4	H408-41400-281M4	H408-41400-483V4	H408-41400-484V4	H408-41400-281V4				
									H410-41400-483N4	H410-41400-484N4	H410-41400-281N4	H410-41400-483M4	H410-41400-484M4	H410-41400-281M4	H410-41400-483V4	H410-41400-484V4	H410-41400-281V4				
									H412-41400-483N4	H412-41400-484N4	H412-41400-281N4	H412-41400-483M4	H412-41400-484M4	H412-41400-281M4	H412-41400-483V4	H412-41400-484V4	H412-41400-281V4				

* larger terminal capacity, see page 154

Further switching programmes from page 132.

Disconnect Switches

Main/Emergency-Off Switches **Base mounting** Snap-on mounting with door interlock

Switching programme	Rated data (IEC 60947)			Mounting dimension (front) (mm)	Padlock device N-handle yellow/red	Padlock device M-handle yellow/red	Padlockable handle V-handle yellow/red
	Operat. current I_e	Operational power (at 380–440 V)			 IP66	 IP66	 IP66
	AC-21A (A)	AC-23A (kW)	AC-3 (kW)		Order code number	Order code number	Order code number

41600
– 6 pole
– without auxiliary contacts

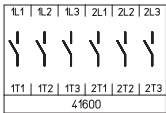

Modular shaft extension:

➔ Modular shaft extensions see page 145!

20	5.5	3.7	36 x 36	H216-41600-234N4	H216-41600-234M4	–
20	5.5	3.7	48 x 48	H216-41600-238N4	H216-41600-238M4	H216-41600-238V4
25	7.5	5.5	36 x 36	H220-41600-234N4	H220-41600-234M4	–
25	7.5	5.5	48 x 48	H220-41600-238N4	H220-41600-238M4	H220-41600-238V4
32	11	7.5	36 x 36	H226-41600-234N4	H226-41600-234M4	–
32	11	7.5	48 x 48	H226-41600-238N4	H226-41600-238M4	H226-41600-238V4
40	15	11	36 x 36	H233-41600-234N4	H233-41600-234M4	–
40	15	11	36 x 36	B240-41600-234N4*	B240-41600-234M4*	–
40	15	11	48 x 48	H233-41600-238N4	H233-41600-238M4	H233-41600-238V4
40	15	11	48 x 48	B240-41600-238N4*	B240-41600-238M4*	B240-41600-238V4*
50	18.5	15	36 x 36	B250-41600-234N4	B250-41600-234M4	–
50	18.5	15	48 x 48	B250-41600-238N4	B250-41600-238M4	B250-41600-238V4
63	22	18.5	36 x 36	B263-41600-234N4	B263-41600-234M4	–
63	22	18.5	48 x 48	B263-41600-238N4	B263-41600-238M4	B263-41600-238V4
63	22	18.5	48 x 48	H406-41600-234N4*	H406-41600-234M4*	H406-41600-234V4*
80	30	22	48 x 48	H408-41600-234N4	H408-41600-234M4	H408-41600-234V4
100	37	30	48 x 48	H410-41600-234N4	H410-41600-234M4	H410-41600-234V4
125	45	37	48 x 48	H412-41600-234N4	H412-41600-234M4	H412-41600-234V4



Metal shaft extension:

➔ Metal shaft is not included. Please order separately, see page 146!

20	5.5	3.7	36 x 36	H216-41600-483N4	H216-41600-483M4	–
20	5.5	3.7	48 x 48	H216-41600-484N4	H216-41600-484M4	H216-41600-484V4
20	5.5	3.7	∅ 22.5	H216-41600-281N4	H216-41600-281M4	–
25	7.5	5.5	36 x 36	H220-41600-483N4	H220-41600-483M4	–
25	7.5	5.5	48 x 48	H220-41600-484N4	H220-41600-484M4	H220-41600-484V4
25	7.5	5.5	∅ 22.5	H220-41600-281N4	H220-41600-281M4	–
32	11	7.5	36 x 36	H226-41600-483N4	H226-41600-483M4	–
32	11	7.5	48 x 48	H226-41600-484N4	H226-41600-484M4	H226-41600-484V4
32	11	7.5	∅ 22.5	H226-41600-281N4	H226-41600-281M4	–
40	15	11	36 x 36	H233-41600-483N4	H233-41600-483M4	–
40	15	11	36 x 36	B240-41600-483N4*	B240-41600-483M4*	–
40	15	11	48 x 48	H233-41600-484N4	H233-41600-484M4	H233-41600-484V4
40	15	11	48 x 48	B240-41600-484N4*	B240-41600-484M4*	B240-41600-484V4*
40	15	11	∅ 22.5	H233-41600-281N4	H233-41600-281M4	–
40	15	11	∅ 22.5	B240-41600-281N4*	B240-41600-281M4*	–
50	18.5	15	36 x 36	B250-41600-483N4	B250-41600-483M4	–
50	18.5	15	48 x 48	B250-41600-484N4	B250-41600-484M4	B250-41600-484V4
50	18.5	15	∅ 22.5	B250-41600-281N4	B250-41600-281M4	–
63	22	18.5	36 x 36	B263-41600-483N4	B263-41600-483M4	–
63	22	18.5	48 x 48	B263-41600-484N4	B263-41600-484M4	B263-41600-484V4
63	22	18.5	48 x 48	H406-41600-483N4*	H406-41600-483M4*	H406-41600-483V4*
63	22	18.5	∅ 22.5	B263-41600-281N4	B263-41600-281M4	–
63	22	18.5	∅ 22.5	H406-41600-281N4*	H406-41600-281M4*	H406-41600-281V4
80	30	22	48 x 48	H408-41600-483N4	H408-41600-483M4	H408-41600-483V4
80	30	22	∅ 22.5	H408-41600-281N4	H408-41600-281M4	H408-41600-281V4
100	37	30	48 x 48	H410-41600-483N4	H410-41600-483M4	H410-41600-483V4
100	37	30	∅ 22.5	H410-41600-281N4	H410-41600-281M4	H410-41600-281V4
125	45	37	48 x 48	H412-41600-483N4	H412-41600-483M4	H412-41600-483V4
125	45	37	∅ 22.5	H412-41600-281N4	H412-41600-281M4	H412-41600-281V4

* larger terminal capacity, see page 154

Further switching programmes from page 132.

Switching programme	Rated data (IEC 60947)			Mounting dimension (front) (mm)	Padlock device N-handle yellow/red	Padlock device M-handle yellow/red	Padlockable handle V-handle yellow/red
	Operat. current I_e	Operational power (at 380–440 V)			 IP66	 IP66	 IP66
	AC-21A (A)	AC-23A (kW)	AC-3 (kW)		Order code number	Order code number	Order code number

41800

- 8 pole
- without auxiliary contacts
- 2 neutral contacts early make/late break

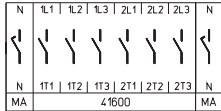

Modular shaft extension:

➔ Modular shaft extensions see page 145!

20	5.5	3.7	36 x 36	H216-41800-234N4	H216-41800-234M4	-
20	5.5	3.7	48 x 48	H216-41800-238N4	H216-41800-238M4	H216-41800-238V4
25	7.5	5.5	36 x 36	H220-41800-234N4	H220-41800-234M4	-
25	7.5	5.5	48 x 48	H220-41800-238N4	H220-41800-238M4	H220-41800-238V4
32	11	7.5	36 x 36	H226-41800-234N4	H226-41800-234M4	-
32	11	7.5	48 x 48	H226-41800-238N4	H226-41800-238M4	H226-41800-238V4
40	15	11	36 x 36	H233-41800-234N4	H233-41800-234M4	-
40	15	11	36 x 36	B240-41800-234N4*	B240-41800-234M4*	-
40	15	11	48 x 48	H233-41800-238N4	H233-41800-238M4	H233-41800-238V4
40	15	11	48 x 48	B240-41800-238N4*	B240-41800-238M4*	B240-41800-238V4*
50	18.5	15	36 x 36	B250-41800-234N4	B250-41800-234M4	-
50	18.5	15	48 x 48	B250-41800-238N4	B250-41800-238M4	B250-41800-238V4
63	22	18.5	36 x 36	B263-41800-234N4	B263-41800-234M4	-
63	22	18.5	48 x 48	B263-41800-238N4	B263-41800-238M4	B263-41800-238V4
63	22	18.5	48 x 48	H406-41800-234N4*	H406-41800-234M4*	H406-41800-234V4*
80	30	22	48 x 48	H408-41800-234N4	H408-41800-234M4	H408-41800-234V4
100	37	30	48 x 48	H410-41800-234N4	H410-41800-234M4	H410-41800-234V4
125	45	37	48 x 48	H412-41800-234N4	H412-41800-234M4	H412-41800-234V4

Metal shaft extension:

➔ Metal shaft is not included. Please order separately, see page 146!

20	5.5	3.7	36 x 36	H216-41800-483N4	H216-41800-483M4	-
20	5.5	3.7	48 x 48	H216-41800-484N4	H216-41800-484M4	H216-41800-484V4
20	5.5	3.7	Ø 22.5	H216-41800-281N4	H216-41800-281M4	-
25	7.5	5.5	36 x 36	H220-41800-483N4	H220-41800-483M4	-
25	7.5	5.5	48 x 48	H220-41800-484N4	H220-41800-484M4	H220-41800-484V4
25	7.5	5.5	Ø 22.5	H220-41800-281N4	H220-41800-281M4	-
32	11	7.5	36 x 36	H226-41800-483N4	H226-41800-483M4	-
32	11	7.5	48 x 48	H226-41800-484N4	H226-41800-484M4	H226-41800-484V4
32	11	7.5	Ø 22.5	H226-41800-281N4	H226-41800-281M4	-
40	15	11	36 x 36	H233-41800-483N4	H233-41800-483M4	-
40	15	11	36 x 36	B240-41800-483N4*	B240-41800-483M4*	-
40	15	11	48 x 48	H233-41800-484N4	H233-41800-484M4	H233-41800-484V4
40	15	11	48 x 48	B240-41800-484N4*	B240-41800-484M4*	B240-41800-484V4*
40	15	11	Ø 22.5	H233-41800-281N4	H233-41800-281M4	-
40	15	11	Ø 22.5	B240-41800-281N4*	B240-41800-281M4*	-
50	18.5	15	36 x 36	B250-41800-483N4	B250-41800-483M4	-
50	18.5	15	48 x 48	B250-41800-484N4	B250-41800-484M4	B250-41800-484V4
50	18.5	15	Ø 22.5	B250-41800-281N4	B250-41800-281M4	-
63	22	18.5	36 x 36	B263-41800-483N4	B263-41800-483M4	-
63	22	18.5	48 x 48	B263-41800-484N4	B263-41800-484M4	B263-41800-484V4
63	22	18.5	48 x 48	H406-41800-483N4*	H406-41800-483M4*	H406-41800-483V4*
63	22	18.5	Ø 22.5	B263-41800-281N4	B263-41800-281M4	-
63	22	18.5	Ø 22.5	H406-41800-281N4*	H406-41800-281M4*	H406-41800-281V4
80	30	22	48 x 48	H408-41800-483N4	H408-41800-483M4	H408-41800-483V4
80	30	22	Ø 22.5	H408-41800-281N4	H408-41800-281M4	H408-41800-281V4
100	37	30	48 x 48	H410-41800-483N4	H410-41800-483M4	H410-41800-483V4
100	37	30	Ø 22.5	H410-41800-281N4	H410-41800-281M4	H410-41800-281V4
125	45	37	48 x 48	H412-41800-483N4	H412-41800-483M4	H412-41800-483V4
125	45	37	Ø 22.5	H412-41800-281N4	H412-41800-281M4	H412-41800-281V4

* larger terminal capacity, see page 154

Further switching programmes from page 132.

Disconnect Switches

Main/Emergency-Off Switches **Base mounting** Snap-on mounting with door interlock

Dimensions in mm:

Door interlock with **modular shaft extension**: Four hole front mounting

Setup of order code number		
Type	Switching progr.	Mtg. form
H233	41400	234N4
Order code no. H233-41400-234N4		

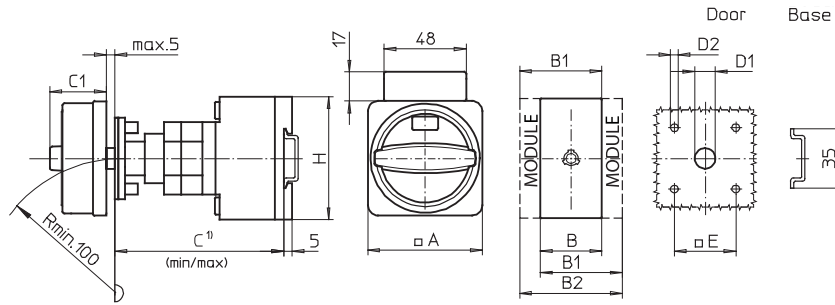

¹⁾ Internal depth: inside of door to top of DIN rail, dimensions with shaft extension see page 145.

Switching programmes 3 and 4 pole

Types H216 / H220 / H226 / H233:

Mtg. form	A	B	B1	B2	C _{min}	C _{max}	C1	D1	D2	E	H
234M4	67	36	48	60	92	107	38	15	4.5	36	70
234N4	67	36	48	60	92	107	33	15	4.5	36	70
234V4	48	36	48	60	92	107	32	12	4.5	36	70
238M4	67	36	48	60	92	107	38	15	5	48	70
238N4	67	36	48	60	92	107	33	15	5	48	70
238V4	64	36	48	60	92	107	39	15	5	48	70

Switching programmes 6 and 8 pole

Types H216 / H220 / H226 / H233:

Mtg. form	A	B	B1	B2	C _{min}	C _{max}	C1	D1	D2	E	H
234M4	67	72	84	96	100	115	38	15	4.5	36	70
234N4	67	72	84	96	100	115	33	15	4.5	36	70
238M4	67	72	84	96	100	115	38	15	5	48	70
238N4	67	72	84	96	100	115	33	15	5	48	70
238V4	64	72	84	96	100	115	39	15	5	48	70

Types B240 / B250 / B263:

Mtg. form	A	B	B1	B2	C _{min}	C _{max}	C1	D1	D2	E	H
234M4	67	50	69	88	92	107	38	15	4.5	36	72
234N4	67	50	69	88	92	107	33	15	4.5	36	72
234V4	48	50	69	88	92	107	32	12	4.5	36	72
238M4	67	50	69	88	92	107	38	15	5	48	72
238N4	67	50	69	88	92	107	33	15	5	48	72
238V4	64	50	69	88	92	107	39	15	5	48	72

Types B240 / B250 / B263:

Mtg. form	A	B	B1	B2	C _{min}	C _{max}	C1	D1	D2	E	H
234M4	67	100	119	138	104	119	38	15	4.5	36	72
234N4	67	100	119	138	104	119	33	15	4.5	36	72
238M4	67	100	119	138	104	119	38	15	5	48	72
238N4	67	100	119	138	104	119	33	15	5	48	72
238V4	64	100	119	138	104	119	39	15	5	48	72

Types H406 / H408 / H410 / H412:

Mtg. form	A	B	B1	B2	C _{min}	C _{max}	C1	D1	D2	E	H
234M4	88	70	89	108	102	117	50	15	5	48	80
234N4	88	70	89	108	102	117	45	15	5	48	80
234V4	64	70	89	108	102	117	40	15	5	48	80

Types H406 / H408 / H410 / H412:

Mtg. form	A	B	B1	B2	C _{min}	C _{max}	C1	D1	D2	E	H
234M4	88	140	159	178	115	130	50	15	5	48	80
234N4	88	140	159	178	115	130	45	15	5	48	80
234V4	64	140	159	178	115	130	40	15	5	48	80

Dimensions in mm:

Door interlock with **metal shaft extension**: Four hole front mounting

Setup of order code number		
Type	Switching progr.	Mtg. form
H406	41800	483N4
Order code no. H406-41800-483N4		

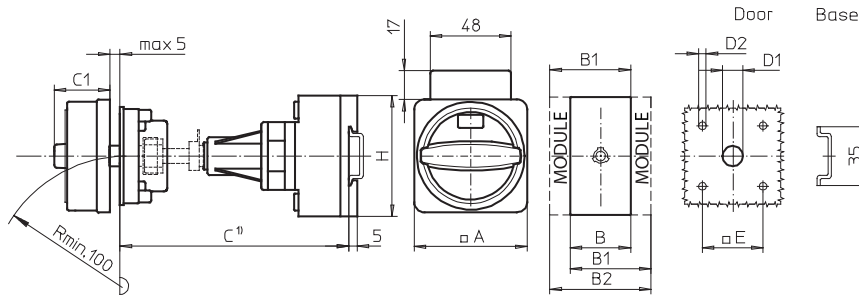

¹⁾ Internal depth: inside of door to top of DIN rail, dimensions see page 146.

Switching programmes 3 and 4 pole

Types H216 / H220 / H226 / H233:

Mtg. form	A	B	B1	B2	C1	D1	D2	E	H
483M4	67	36	48	60	38	15	4.5	36	70
483N4	67	36	48	60	33	15	4.5	36	70
483V4	48	36	48	60	32	15	4.5	36	70
484M4	67	36	48	60	38	15	5	48	70
484N4	67	36	48	60	33	15	5	48	70
484V4	64	36	48	60	39	15	5	48	70

Types B240 / B250 / B263:

Mtg. form	A	B	B1	B2	C1	D1	D2	E	H
483M4	67	50	69	88	38	15	4.5	36	72
483N4	67	50	69	88	33	15	4.5	36	72
483V4	48	50	69	88	32	15	4.5	36	72
484M4	67	50	69	88	38	15	5	48	72
484N4	67	50	69	88	33	15	5	48	72
484V4	64	50	69	88	39	15	5	48	72

Types H406 / H408 / H410 / H412:

Mtg. form	A	B	B1	B2	C1	D1	D2	E	H
483M4	88	70	89	108	50	15	5	48	80
483N4	88	70	89	108	45	15	5	48	80
483V4	64	70	89	108	40	15	5	48	80

Switching programmes 6 and 8 pole

Types H216 / H220 / H226 / H233:

Mtg. form	A	B	B1	B2	C1	D1	D2	E	H
483M4	67	72	84	96	38	15	4.5	36	70
483N4	67	72	84	96	33	15	4.5	36	70
484M4	67	72	84	96	38	15	5	48	70
484N4	67	72	84	96	33	15	5	48	70
484V4	64	72	84	96	39	15	5	48	70

Types B240 / B250 / B263:

Mtg. form	A	B	B1	B2	C1	D1	D2	E	H
483M4	67	100	119	138	38	15	4.5	36	72
483N4	67	100	119	138	33	15	4.5	36	72
484M4	67	100	119	138	38	15	5	48	72
484N4	67	100	119	138	33	15	5	48	72
484V4	64	100	119	138	39	15	5	48	72

Types H406 / H408 / H410 / H412:

Mtg. form	A	B	B1	B2	C1	D1	D2	E	H
483M4	88	140	159	178	50	15	5	48	80
483N4	88	140	159	178	45	15	5	48	80
483V4	64	140	159	178	40	15	5	48	80

Disconnect Switches

Main/Emergency-Off Switches **Base mounting** Snap-on mounting with door interlock

Dimensions in mm:

Door interlock with **metal shaft extension**: Single hole front mounting

Setup of order code number		
Type	Switching progr.	Mtg. form
H233	41400	281N4
Order code no. H233-41400-281N4		

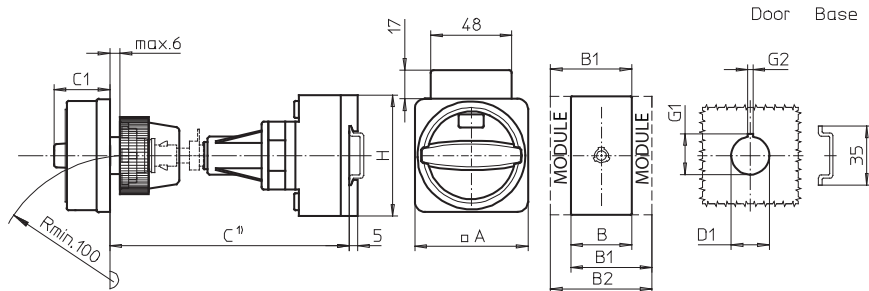

¹⁾ Internal depth: outside of door to top of DIN rail, dimensions see page 146.

Switching programmes 3 and 4 pole

Types H216 / H220 / H226 / H233:

Mtg. form	A	B	B1	B2	C1	D1	G1	G2	H
281M4	67	36	48	60	38	22.5	24.2	3.2	70
281N4	67	36	48	60	33	22.5	24.2	3.2	70
281V4	48	36	48	60	32	22.5	24.2	3.2	70

Types B240 / B250 / B263:

Mtg. form	A	B	B1	B2	C1	D1	G1	G2	H
281M4	67	50	69	88	38	22.5	24.2	3.2	72
281N4	67	50	69	88	33	22.5	24.2	3.2	72
281V4	48	50	69	88	32	22.5	24.2	3.2	72

Types H406 / H408 / H410 / H412:

Mtg. form	A	B	B1	B2	C1	D1	G1	G2	H
281M4	67	70	89	108	38	22.5	24.2	3.2	80
281N4	67	70	89	108	33	22.5	24.2	3.2	80
281V4	64	70	89	108	39	22.5	24.2	3.2	80

Switching programmes 6 and 8 pole

Types H216 / H220 / H226 / H233:

Mtg. form	A	B	B1	B2	C1	D1	G1	G2	H
281M4	67	72	84	96	38	22.5	24.2	3.2	70
281N4	67	72	84	96	33	22.5	24.2	3.2	70

Types B240 / B250 / B263:

Mtg. form	A	B	B1	B2	C1	D1	G1	G2	H
281M4	67	100	119	138	38	22.5	24.2	3.2	72
281N4	67	100	119	138	33	22.5	24.2	3.2	72



Types H406 / H408 / H410 / H412:

Mtg. form	A	B	B1	B2	C1	D1	G1	G2	H
281M4	67	140	159	178	38	22.5	24.2	3.2	80
281N4	67	140	159	178	33	22.5	24.2	3.2	80
281V4	64	140	159	178	39	22.5	24.2	3.2	80

Main/Emergency-Off Switches

- Base mounting switches with four hole mounting
- Door interlock
- 3 up to 8 pole
- 160 A up to 315 A
- IP55



Switching programme	Rated data (IEC 60947)			Mounting dimension (base/front) (mm)	Padlock device N-handle yellow/red	Padlock device M-handle yellow/red	Padlock device H-handle yellow/red
	Operat. current I_e	Operational power (at 380–440 V)			 OFF-ON IP55	 OFF-ON IP55	 OFF-ON IP55
	AC-21A (A)	AC-23A (kW)	AC-3 (kW)		Order code number	Order code number	Order code number
41300 – 3 pole – without auxiliary contacts	160	75	45	68 × 68 / 68 × 68	K616-41300-034N4	K616-41300-034M4	K616-41300-034H4
	315	132	55	104 × 104 / 104 × 104	–	–	K830-41300-034H4



41400 – 4 pole – without auxiliary contacts – neutral contact early make/late break	160	75	45	68 × 68 / 68 × 68	K616-41400-034N4	K616-41400-034M4	K616-41400-034H4
	315	132	55	104 × 104 / 104 × 104	–	–	K830-41400-034H4

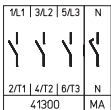

41600 – 6 pole – without auxiliary contacts	160	75	45	68 × 68 / 68 × 68	K616-41600-034N4	K616-41600-034M4	K616-41600-034H4
	315	132	55	104 × 104 / 104 × 104	–	–	K830-41600-034H4

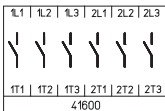

41800 – 8 pole – without auxiliary contacts – 2 neutral contacts early make/late break	160	75	45	68 × 68 / 68 × 68	K616-41800-034N4	K616-41800-034M4	K616-41800-034H4
	315	132	55	104 × 104 / 104 × 104	–	–	K830-41800-034H4

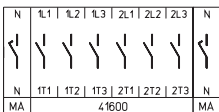

Disconnect Switches

Main/Emergency-Off Switches **Base mounting** Four hole mounting with door interlock

Dimensions in mm:

Setup of order code number		
Type	Switching progr.	Mtg. form
K616	41300	034N4
Order code no.	K616-41300-034N4	

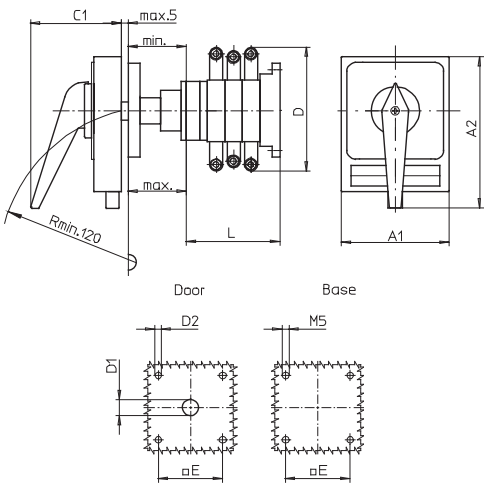
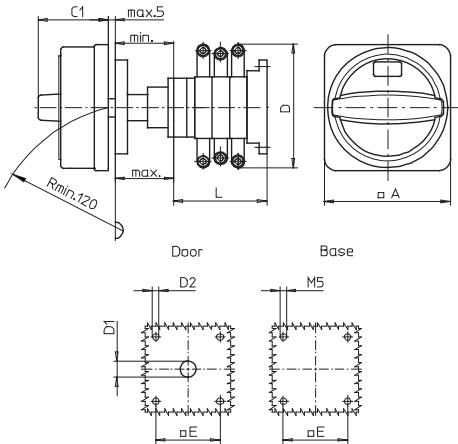

Type K616:

Mtg. form	Switching progr.	A	C1	D*	D1	D2	E	min	max	L
034M4	41300	88	50	150	15	5.5	68	48	60	104
034M4	41400	88	50	150	15	5.5	68	48	60	104
034M4	41600	88	50	150	15	5.5	68	48	60	136
034M4	41800	88	50	150	15	5.5	68	48	60	168
034N4	41300	88	45	150	15	5.5	68	48	60	104
034N4	41400	88	45	150	15	5.5	68	48	60	104
034N4	41600	88	45	150	15	5.5	68	48	60	136
034N4	41800	88	45	150	15	5.5	68	48	60	168

Type K616:

Mtg. form	Switching progr.	A1	A2	C1	D*	D1	D2	E	min	max	L
034H4	41300	98	142	83	150	15	5.5	68	48	60	104
034H4	41400	98	142	83	150	15	5.5	68	48	60	104
034H4	41600	98	142	83	150	15	5.5	68	48	60	136
034H4	41800	98	142	83	150	15	5.5	68	48	60	168

Type K830:

Mtg. form	Switching progr.	A1	A2	C1	D*	D1	D2	E	min	max	L
034H4	41300	130	176	93	210	20	5.5	104	75	102	125
034H4	41400	130	176	93	210	20	5.5	104	75	102	125
034H4	41600	130	176	93	210	20	5.5	104	75	102	161
034H4	41800	130	176	93	210	20	5.5	104	75	102	197

* terminal lugs included

Further switching programmes and corresponding dimensions for types K on request.

Main/Emergency-Off Switches

- Enclosed switches with insulated enclosure (polycarbonate)
- Cover interlock in ON position
- 3 up to 8 pole
- 20 A up to 315 A
- IP66



Switching programme	Rated data (IEC 60947)			Enclosure dimension (H × W × D) (mm)	Padlock device N-handle yellow/red	Padlock device M-handle yellow/red	Padlockable handle V-handle yellow/red
	Operat. current I _e (A)	Operational power (at 380–440 V) (kW)			 IP66	 IP66	 IP66
	AC-21A (A)	AC-23A (kW)	AC-3 (kW)		Order code number	Order code number	Order code number
41300 – 3 pole – without auxiliary contacts 	20	5.5	3.7	125 × 100 × 85	H216-41300-700N4	H216-41300-700M4	H216-41300-700V4
	20	5.5	3.7	175 × 115 × 100	H216-41300-710N4	H216-41300-710M4	H216-41300-710V4
	20	5.5	3.7	250 × 160 × 120	H216-41300-730N4	H216-41300-730M4	H216-41300-730V4
	25	7.5	5.5	125 × 100 × 85	H220-41300-700N4	H220-41300-700M4	H220-41300-700V4
	25	7.5	5.5	175 × 115 × 100	H220-41300-710N4	H220-41300-710M4	H220-41300-710V4
	25	7.5	5.5	250 × 160 × 120	H220-41300-730N4	H220-41300-730M4	H220-41300-730V4
	32	11	7.5	125 × 100 × 85	H226-41300-700N4	H226-41300-700M4	H226-41300-700V4
	32	11	7.5	175 × 115 × 100	H226-41300-710N4	H226-41300-710M4	H226-41300-710V4
	32	11	7.5	250 × 160 × 120	H226-41300-730N4	H226-41300-730M4	H226-41300-730V4
	40	15	11	175 × 115 × 100	H233-41300-710N4	H233-41300-710M4	H233-41300-710V4
	40	15	11	175 × 115 × 100	B240-41300-710N4*¹	B240-41300-710M4*¹	B240-41300-710V4*¹
	40	15	11	250 × 160 × 120	H233-41300-730N4	H233-41300-730M4	H233-41300-730V4
	40	15	11	250 × 160 × 120	B240-41300-730N4*	B240-41300-730M4*	B240-41300-730V4*
	50	18.5	15	175 × 115 × 100	B250-41300-710N4¹	B250-41300-710M4¹	B250-41300-710V4¹
	50	18.5	15	250 × 160 × 120	B250-41300-730N4	B250-41300-730M4	B250-41300-730V4
	63	22	18.5	175 × 115 × 100	B263-41300-710N4¹	B263-41300-710M4¹	B263-41300-710V4¹
	63	22	18.5	250 × 160 × 120	B263-41300-730N4	B263-41300-730M4	B263-41300-730V4
	63	22	18.5	250 × 160 × 120	H406-41300-730N4*	H406-41300-730M4*	–
	63	22	18.5	280 × 190 × 130	H406-41300-770N4	H406-41300-770M4	H406-41300-770V4
	63	22	18.5	320 × 220 × 180	H406-41300-477N4	H406-41300-477M4	–
	80	30	22	250 × 160 × 120	H408-41300-730N4	H408-41300-730M4	–
	80	30	22	280 × 190 × 130	H408-41300-770N4	H408-41300-770M4	H408-41300-770V4
	80	30	22	320 × 220 × 180	H408-41300-477N4	H408-41300-477M4	–
	100	37	30	250 × 160 × 120	H410-41300-730N4	H410-41300-730M4	–
100	37	30	280 × 190 × 130	H410-41300-770N4	H410-41300-770M4	H410-41300-770V4	
100	37	30	320 × 220 × 180	H410-41300-477N4	H410-41300-477M4	–	
125	45	37	320 × 220 × 180	H412-41300-477N4	H412-41300-477M4	–	

* larger terminal capacity, see page 154

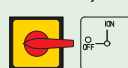

¹ Terminal capacity max. 16 mm² on N-terminal and/or PE-terminal

Further switching programmes as of page 132.

Rated data (IEC 60947)			Enclosure dimension (H × W × D) (mm)	Padlock device H-handle yellow/red
Operat. current I _e (A)	Operational power (at 380–440 V) (kW)			 IP66
AC-21A (A)	AC-23A (kW)	AC-3 (kW)		Order code number
160	75	45	440 × 320 × 180	K616-41300-077H4
160	75	45	440 × 320 × 255	K616-41300-177H4
315	132	55	640 × 320 × 255	K830-41300-077H4
315	132	55	640 × 320 × 330	K830-41300-177H4

Disconnect Switches

Main/Emergency-Off Switches Enclosed Switches – Insulated Enclosure

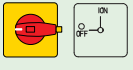
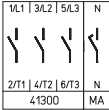
Switching programme	Rated data (IEC 60947)			Enclosure dimension (H × W × D) (mm)	Padlock device N-handle yellow/red	Padlock device M-handle yellow/red	Padlockable handle V-handle yellow/red
	Operat. current I _e (A)	Operational power (at 380–440 V) AC-23A (kW)	AC-3 (kW)				
					IP66	IP66	IP66
	AC-21A (A)	AC-23A (kW)	AC-3 (kW)		Order code number	Order code number	Order code number
41400 – 4 pole – without auxiliary contacts – neutral contact – early make/late break 	20	5.5	3.7	125 × 100 × 85	H216-41400-700N4	H216-41400-700M4	H216-41400-700V4
	20	5.5	3.7	175 × 115 × 100	H216-41400-710N4	H216-41400-710M4	H216-41400-710V4
	20	5.5	3.7	250 × 160 × 120	H216-41400-730N4	H216-41400-730M4	H216-41400-730V4
	25	7.5	5.5	125 × 100 × 85	H220-41400-700N4	H220-41400-700M4	H220-41400-700V4
	25	7.5	5.5	175 × 115 × 100	H220-41400-710N4	H220-41400-710M4	H220-41400-710V4
	25	7.5	5.5	250 × 160 × 120	H220-41400-730N4	H220-41400-730M4	H220-41400-730V4
	32	11	7.5	125 × 100 × 85	H226-41400-700N4	H226-41400-700M4	H226-41400-700V4
	32	11	7.5	175 × 115 × 100	H226-41400-710N4	H226-41400-710M4	H226-41400-710V4
	32	11	7.5	250 × 160 × 120	H226-41400-730N4	H226-41400-730M4	H226-41400-730V4
	40	15	11	175 × 115 × 100	H233-41400-710N4	H233-41400-710M4	H233-41400-710V4
	40	15	11	175 × 115 × 100	B240-41400-710N4*¹	B240-41400-710M4*¹	B240-41400-710V4*¹
	40	15	11	250 × 160 × 120	H233-41400-730N4	H233-41400-730M4	H233-41400-730V4
	40	15	11	250 × 160 × 120	B240-41400-730N4*	B240-41400-730M4*	B240-41400-730V4*
	50	18.5	15	175 × 115 × 100	B250-41400-710N4¹	B250-41400-710M4¹	B250-41400-710V4¹
	50	18.5	15	250 × 160 × 120	B250-41400-730N4	B250-41400-730M4	B250-41400-730V4
	63	22	18.5	175 × 115 × 100	B263-41400-710N4¹	B263-41400-710M4¹	B263-41400-710V4¹
	63	22	18.5	250 × 160 × 120	B263-41400-730N4	B263-41400-730M4	B263-41400-730V4
	63	22	18.5	250 × 160 × 120	H406-41400-730N4*	H406-41400-730M4*	–
	63	22	18.5	280 × 190 × 130	H406-41400-770N4	H406-41400-770M4	H406-41400-770V4
	63	22	18.5	320 × 220 × 180	H406-41400-477N4	H406-41400-477M4	–
	80	30	22	250 × 160 × 120	H408-41400-730N4	H408-41400-730M4	–
	80	30	22	280 × 190 × 130	H408-41400-770N4	H408-41400-770M4	H408-41400-770V4
	80	30	22	320 × 220 × 180	H408-41400-477N4	H408-41400-477M4	–
	100	37	30	250 × 160 × 120	H410-41400-730N4	H410-41400-730M4	–
	100	37	30	280 × 190 × 130	H410-41400-770N4	H410-41400-770M4	H410-41400-770V4
	100	37	30	320 × 220 × 180	H410-41400-477N4	H410-41400-477M4	–
125	45	37	320 × 220 × 180	H412-41400-477N4	H412-41400-477M4	–	

Rated data (IEC 60947)			Enclosure dimension (H × W × D) (mm)	Padlock device H-handle yellow/red
Operat. current I _e (A)	Operational power (at 380–440 V) AC-23A (kW)	AC-3 (kW)		
			IP66	
AC-21A (A)	AC-23A (kW)	AC-3 (kW)		Order code number
160	75	45	440 × 320 × 180	K616-41400-077H4
160	75	45	440 × 320 × 255	K616-41400-177H4
315	132	55	640 × 320 × 255	K830-41400-077H4
315	132	55	640 × 320 × 330	K830-41400-177H4

* larger terminal capacity, see page 154

¹ Terminal capacity max. 16 mm² on N-terminal and/or PE-terminal

Further switching programmes from page 132.

Disconnect Switches

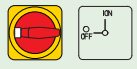
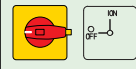
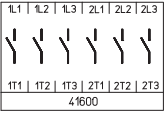

Main/Emergency-Off Switches Enclosed Switches – Insulated Enclosure

Switching programme	Rated data (IEC 60947)			Enclosure dimension (H × W × D) (mm)	Padlock device N-handle yellow/red	Padlock device M-handle yellow/red	Padlockable handle V-handle yellow/red
	Operat. current I_e (A)	Operational power (at 380–440 V) AC-23A (kW)	AC-3 (kW)		 IP66	 IP66	 IP66
					Order code number	Order code number	Order code number
41600 – 6 pole – without auxiliary contacts 	20	5.5	3.7	175 × 115 × 100	H216-41600-720N4	H216-41600-720M4	H216-41600-720V4
	20	5.5	3.7	250 × 160 × 120	H216-41600-733N4	H216-41600-733M4	H216-41600-733V4
	25	7.5	5.5	175 × 115 × 100	H220-41600-720N4	H220-41600-720M4	H220-41600-720V4
	25	7.5	5.5	250 × 160 × 120	H220-41600-733N4	H220-41600-733M4	H220-41600-733V4
	32	11	7.5	175 × 115 × 100	H226-41600-720N4	H226-41600-720M4	H226-41600-720V4
	32	11	7.5	250 × 160 × 120	H226-41600-733N4	H226-41600-733M4	H226-41600-733V4
	40	15	11	175 × 115 × 100	H233-41600-720N4	H233-41600-720M4	H233-41600-720V4
	40	15	11	250 × 160 × 120	H233-41600-733N4	H233-41600-733M4	H233-41600-733V4
	40	15	11	320 × 220 × 180	B240-41600-977N4	B240-41600-977M4	–
	50	18.5	15	320 × 220 × 180	B250-41600-977N4	B250-41600-977M4	–
	63	22	18.5	320 × 220 × 180	B263-41600-977N4	B263-41600-977M4	–
	63	22	18.5	320 × 220 × 180	H406-41600-977N4*	H406-41600-977M4*	–
	63	22	18.5	440 × 320 × 180	H406-41600-577N4	H406-41600-577M4	–
	80	30	22	320 × 220 × 180	H408-41600-977N4	H408-41600-977M4	–
	80	30	22	440 × 320 × 180	H408-41600-577N4	H408-41600-577M4	–
	100	37	30	320 × 220 × 180	H410-41600-977N4	H410-41600-977M4	–
	100	37	30	440 × 320 × 180	H410-41600-577N4	H410-41600-577M4	–
125	45	37	320 × 220 × 180	H412-41600-577N4	H412-41600-977M4	–	
125	45	37	440 × 320 × 180	H412-41600-577N4	H412-41600-577M4	–	



Rated data (IEC 60947)			Enclosure dimension (H × W × D) (mm)	Padlock device H-handle yellow/red
Operat. current I_e (A)	Operational power (at 380–440 V) AC-23A (kW)	AC-3 (kW)		 IP66
				Order code number
160	75	45	440 × 320 × 255	K616-41600-177H4
315	132	55	640 × 320 × 330	K830-41600-177H4

* larger terminal capacity, see page 154

Further switching programmes from page 132.

Disconnect Switches

Main/Emergency-Off Switches Enclosed Switches – Insulated Enclosure

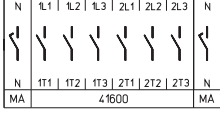
Switching programme	Rated data (IEC 60947)			Enclosure dimension (H × W × D) (mm)	Padlock device N-handle yellow/red	Padlock device M-handle yellow/red	Padlockable handle V-handle yellow/red
	Operat. current I _e (A)	Operational power (at 380–440 V) (kW)			 IP66	 IP66	 IP66
		AC-21A	AC-23A		AC-3	Order code number	Order code number
41800 – 8 pole – without auxiliary contacts – 2 neutral contacts – early make/late break 	20	5.5	3.7	250 × 160 × 120	H216-41800-733N4	H216-41800-733M4	H216-41800-733V4
	20	5.5	3.7	280 × 190 × 130	H216-41800-770N4	H216-41800-770M4	H216-41800-770V4
	25	7.5	5.5	250 × 160 × 120	H220-41800-733N4	H220-41800-733M4	H220-41800-733V4
	25	7.5	5.5	280 × 190 × 130	H220-41800-770N4	H220-41800-770M4	H220-41800-770V4
	32	11	7.5	250 × 160 × 120	H226-41800-733N4	H226-41800-733M4	H226-41800-733V4
	32	11	7.5	280 × 190 × 130	H226-41800-770N4	H226-41800-770M4	H226-41800-770V4
	40	15	11	250 × 160 × 120	H233-41800-733N4	H233-41800-733M4	H233-41800-733V4
	40	15	11	280 × 190 × 130	H233-41800-770N4	H233-41800-770M4	H233-41800-770V4
	40	15	11	280 × 190 × 130	B240-41800-770N4*¹	B240-41800-770M4*¹	B240-41800-770V4*¹
	40	15	11	320 × 220 × 180	B240-41800-977N4	B240-41800-977M4	–
	50	18.5	15	280 × 190 × 130	B250-41800-770N4¹	B250-41800-770M4¹	B250-41800-770V4¹
	50	18.5	15	320 × 220 × 180	B250-41800-977N4	B250-41800-977M4	–
	63	22	18.5	280 × 190 × 130	B263-41800-770N4¹	B263-41800-770M4¹	B263-41800-770V4¹
	63	22	18.5	320 × 220 × 180	B263-41800-977N4	B263-41800-977M4	–
	63	22	18.5	320 × 220 × 180	H406-41800-977N4*	H406-41800-977M4*	–
	63	22	18.5	440 × 320 × 180	H406-41800-577N4	H406-41800-577M4	–
	80	30	22	320 × 220 × 180	H408-41800-977N4	H408-41800-977M4	–
	80	30	22	440 × 320 × 180	H408-41800-577N4	H408-41800-577M4	–
	100	37	30	320 × 220 × 180	H410-41800-977N4	H410-41800-977M4	–
	100	37	30	440 × 320 × 180	H410-41800-577N4	H410-41800-577M4	–
125	45	37	320 × 220 × 180	H412-41800-977N4	H412-41800-977M4	–	
125	45	37	440 × 320 × 180	H412-41800-577N4	H412-41800-577M4	–	

Rated data (IEC 60947)			Enclosure dimension (H × W × D) (mm)	Padlock device H-handle yellow/red
Operat. current I _e (A)	Operational power (at 380–440 V) (kW)			 IP66
	AC-21A	AC-23A	AC-3	Order code number
160	75	45	440 × 320 × 255	K616-41800-177H4
315	132	55	640 × 320 × 330	K830-41800-177H4

* larger terminal capacity, see page 154

¹ Terminal capacity max. 16 mm² on N-terminal and/or PE-terminal

Further switching programmes from page 132.

Dimensions in mm:

Setup of order code number

Type	Switching progr.	Mtg. form
H216	41400	700M4
Order code no.	H216-41400-700M4	

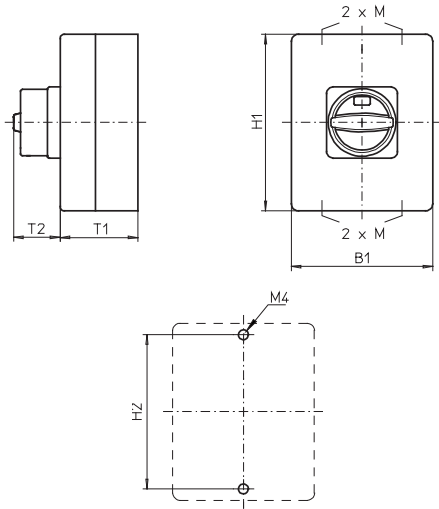

Insulated enclosures **125 × 100 × 85 mm**
and **175 × 115 × 100 mm**:

Types H216 / H220 / H226 / H233 / B240 / B250 / B263:

Mtg. form	H1	B1	T1	T2	2×M	H2
700M4	125	100	85	38	20/25	115
700N4	125	100	85	33	20/25	115
700V4	125	100	85	32	20/25	115
710M4	175	115	100	38	20/25	165
710N4	175	115	100	33	20/25	165
710V4	175	115	100	39	20/25	165
720M4	175	115	100	38	20/25	165
720N4	175	115	100	33	20/25	165
720V4	175	115	100	39	20/25	165

Insulated enclosure **250 × 160 × 120 mm**:

Types H216 / H220 / H226 / H233:

Mtg. form	H1	B1	T1	T2	2×M	H2
730M4	250	160	120	38	32/40	235
730N4	250	160	120	33	32/40	235
730V4	250	160	120	39	32/40	235
733M4	250	160	120	38	32/40	235
733N4	250	160	120	33	32/40	235
733V4	250	160	120	39	32/40	235

Types B240 / B250 / B263:

Mtg. form	H1	B1	T1	T2	2×M	H2
730M4	250	160	120	50	32/40	235
730N4	250	160	120	45	32/40	235
730V4	250	160	120	39	32/40	235

Types H406 / H408 / H410 / H412:

Mtg. form	H1	B1	T1	T2	2×M	H2
730M4	250	160	120	50	32/40	235
730N4	250	160	120	45	32/40	235

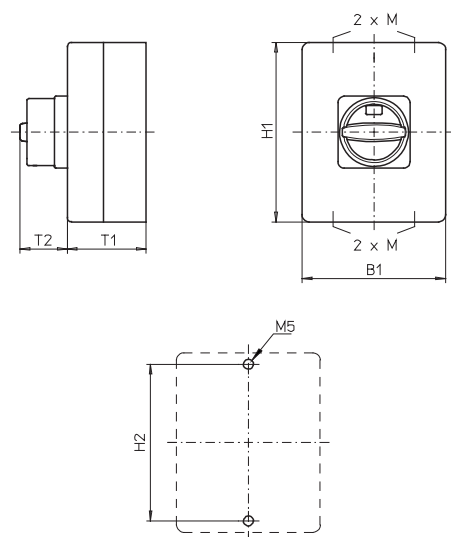

Disconnect Switches

Main/Emergency-Off Switches Enclosed Switches – Insulated Enclosure

Dimensions in mm:

Setup of order code number

Type	Switching progr.	Mtg. form
H406	41300	770M4
Order code no.	H406-41300-770M4	

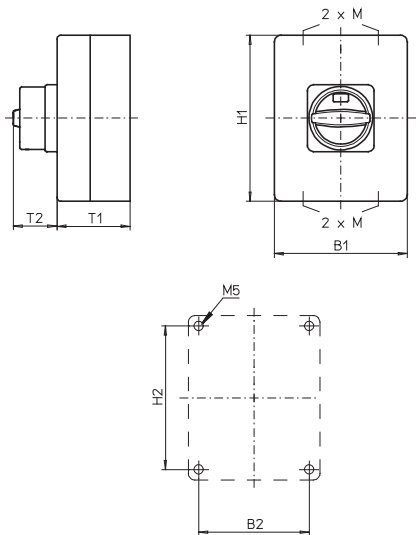

Insulated enclosures **280 × 190 × 130 mm**
and **320 × 220 × 180 mm**:

Types H216 / H220 / H226 / H233 / B240 / B250 / B263 /
H406 / H408 / H410 / H412:

Mtg. form	H1	B1	T1	T2	2×M	H2	B2
770M4	280	190	130	50	40×1.5	254	164
770N4	280	190	130	45	40×1.5	254	164
770V4	280	190	130	39	40×1.5	254	164
477M4	320	220	180	50	50 ¹	293	193
477N4	320	220	180	45	50 ¹	293	193
977M4	320	220	180	50	– ²	293	193
977N4	320	220	180	45	– ²	293	193

¹ Gland plates with knockouts

² Blank gland plates

Insulated enclosures **440 × 320 × 180 mm /**
440 × 320 × 255 mm / 640 × 320 × 255 mm /
640 × 320 × 330 mm:

Types H406 / H408 / H410 / H412:

Mtg. form	H1	B1	T1	T2	H2	B2
577M4	440	320	180	50	480	293
577N4	440	320	180	45	480	293

Type K616:

Mtg. form	H1	B1	T1	T2	H2	B2
077H4	440	320	180	83	480	293
177H4	440	320	255	83	480	293

Type K830:

Mtg. form	H1	B1	T1	T2	H2	B2
077H4	640	320	255	93	680	293
177H4	640	320	330	93	680	293

Further switching programmes and corresponding dimensions for types K on request.

Blank gland plates

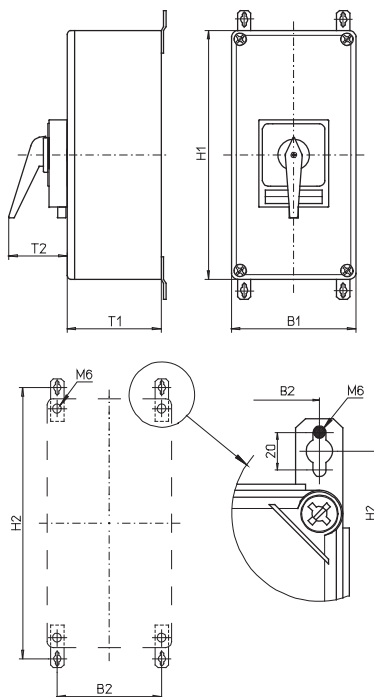

Mounting brackets are included.

Main/Emergency-Off Switches

- Enclosed switches with insulated enclosure (polycarbonate)
- EMV/EMC application, connection system for the uninterrupted connection of shielded/screened cables consisting of shroud and 4 shroud clamps \varnothing 12–16 mm
- Cover interlock in ON position
- 3 up to 6 pole
- 20 A up to 63 A
- IP66



Switching programme	Rated data (IEC 60947)			Enclosure dimension (H x W x D) (mm)	Padlock device N-handle yellow/red	Padlock device M-handle yellow/red	Padlockable handle V-handle yellow/red
	Operat. current I _e	Operational power (at 380–440 V)					
	AC-21A (A)	AC-23A (kW)	AC-3 (kW)		IP66	IP66	IP66
					Order code number	Order code number	Order code number
41300 – 3 pole – without auxiliary contacts 	20	5.5	3.7	175 x 115 x 100	H216-41300-715N4	H216-41300-715M4	H216-41300-715V4
	25	7.5	5.5	175 x 115 x 100	H220-41300-715N4	H220-41300-715M4	H220-41300-715V4
	32	11	7.5	175 x 115 x 100	H226-41300-715N4	H226-41300-715M4	H226-41300-715V4
	40	15	11	175 x 115 x 100	H233-41300-715N4	H233-41300-715M4	H233-41300-715V4
	40	15	11	175 x 115 x 100	B240-41300-715N4*	B240-41300-715M4*	B240-41300-715V4*
	50	18.5	15	175 x 115 x 100	B250-41300-715N4	B250-41300-715M4	B250-41300-715V4
	63	22	18.5	175 x 115 x 100	B263-41300-715N4	B263-41300-715M4	B263-41300-715V4
41400 – 4 pole – without auxiliary contacts – neutral contact early make/late break 	20	5.5	3.7	175 x 115 x 100	H216-41400-715N4	H216-41400-715M4	H216-41400-715V4
	25	7.5	5.5	175 x 115 x 100	H220-41400-715N4	H220-41400-715M4	H220-41400-715V4
	32	11	7.5	175 x 115 x 100	H226-41400-715N4	H226-41400-715M4	H226-41400-715V4
	40	15	11	175 x 115 x 100	H233-41400-715N4	H233-41400-715M4	H233-41400-715V4
	40	15	11	175 x 115 x 100	B240-41400-715N4*	B240-41400-715M4*	B240-41400-715V4*
	50	18.5	15	175 x 115 x 100	B250-41400-715N4	B250-41400-715M4	B250-41400-715V4
	63	22	18.5	175 x 115 x 100	B263-41400-715N4	B263-41400-715M4	B263-41400-715V4
41600 – 6 pole – without auxiliary contacts 	20	5.5	3.7	175 x 115 x 100	H216-41600-725N4	H216-41600-725M4	H216-41600-725V4
	25	7.5	5.5	175 x 115 x 100	H220-41600-725N4	H220-41600-725M4	H220-41600-725V4
	32	11	7.5	175 x 115 x 100	H226-41600-725N4	H226-41600-725M4	H226-41600-725V4
	40	15	11	175 x 115 x 100	H233-41600-725N4	H233-41600-725M4	H233-41600-725V4

* larger terminal capacity, see page 154
Further switching programmes from page 132.

Dimensions in mm:

Types H216 / H220 / H226 / H233 / B240 / B250 / B263:

Mtg. form	H1	B1	T1	T2	2xM	H2
715M4	175	115	100	38	20/25	165
715N4	175	115	100	33	20/25	165
715V4	175	115	100	39	20/25	165
725M4	175	115	100	38	20/25	165
725N4	175	115	100	33	20/25	165
725V4	175	115	100	39	20/25	165



Disconnect Switches

Main/Emergency-Off Switches Enclosed Switches – Mild Steel Enclosure

Main/Emergency-Off Switches

- Enclosed switches with mild steel enclosure (powder coated – RAL 7035)
- Cover interlock in ON position
- 3 up to 8 pole
- 20 A up to 315 A
- IP66



Switching programme	Rated data (IEC 60947)			Enclosure dimension (H × W × D) (mm)	Padlock device N-handle yellow/red	Padlock device M-handle yellow/red	Padlockable handle V-handle yellow/red
	Operat. current I _e (A)	Operational power (at 380–440 V) (kW)			 IP66	 IP66	 IP66
	AC-21A (A)	AC-23A (kW)	AC-3 (kW)		Order code number	Order code number	Order code number
41300 – 3 pole – without auxiliary contacts 	20	5.5	3.7	150 × 150 × 120	H216-41300-087N4	H216-41300-087M4	H216-41300-087V4
	20	5.5	3.7	200 × 150 × 120	H216-41300-187N4	H216-41300-187M4	H216-41300-187V4
	25	7.5	5.5	150 × 150 × 120	H220-41300-087N4	H220-41300-087M4	H220-41300-087V4
	25	7.5	5.5	200 × 150 × 120	H220-41300-187N4	H220-41300-187M4	H220-41300-187V4
	32	11	7.5	150 × 150 × 120	H226-41300-087N4	H226-41300-087M4	H226-41300-087V4
	32	11	7.5	200 × 150 × 120	H226-41300-187N4	H226-41300-187M4	H226-41300-187V4
	40	15	11	200 × 150 × 120	H233-41300-187N4	H233-41300-187M4	H233-41300-187V4
	40	15	11	200 × 150 × 120	B240-41300-087N4*	B240-41300-087M4*	B240-41300-087V4*
	50	18.5	15	200 × 150 × 120	B250-41300-087N4	B250-41300-087M4	B250-41300-087V4
	63	22	18.5	200 × 150 × 120	B263-41300-087N4	B263-41300-087M4	B263-41300-087V4
	63	22	18.5	200 × 150 × 120	H406-41300-987N4*	H406-41300-987M4*	–
	63	22	18.5	300 × 250 × 150	H406-41300-187N4	H406-41300-187M4	–
	63	22	18.5	400 × 300 × 155	H406-41300-182N4¹	H406-41300-182M4¹	–
	80	30	22	200 × 150 × 120	H408-41300-987N4	H408-41300-987M4	–
	80	30	22	300 × 250 × 150	H408-41300-187N4	H408-41300-187M4	–
	80	30	22	400 × 300 × 155	H408-41300-182N4¹	H408-41300-182M4¹	–
100	37	30	300 × 250 × 150	H410-41300-187N4	H410-41300-187M4	–	
100	37	30	400 × 300 × 155	H410-41300-182N4¹	H410-41300-182M4¹	–	
125	45	37	300 × 250 × 150	H412-41300-187N4	H412-41300-187M4	–	
125	45	37	400 × 300 × 155	H412-41300-182N4¹	H412-41300-182M4¹	–	

Rated data (IEC 60947)			Enclosure dimension (H × W × D) (mm)	Padlock device H-handle yellow/red	
Operat. current I _e (A)	Operational power (at 380–440 V) (kW)			 IP66	Order code number
160	75	45	500 × 400 × 300	K616-41300-187H4¹	
315	132	55	600 × 400 × 300	K830-41300-187H4¹	
315	132	55	800 × 400 × 300	K830-41300-287H4¹	

* larger terminal capacity, see page 154



¹ hinged door

Further switching programmes from page 132.

Disconnect Switches

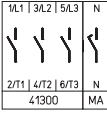

Main/Emergency-Off Switches Enclosed Switches – Mild Steel Enclosure

Switching programme	Rated data (IEC 60947)			Enclosure dimension (H × W × D) (mm)	Padlock device N-handle yellow/red	Padlock device M-handle yellow/red	Padlockable handle V-handle yellow/red
	Operat. current I _e	Operational power (at 380–440 V)			 IP66	 IP66	 IP66
	AC-21A (A)	AC-23A (kW)	AC-3 (kW)		Order code number	Order code number	Order code number
41400 – 4 pole – without auxiliary contacts – neutral contact – early make/late break 	20	5.5	3.7	150 × 150 × 120	H216-41400-087N4	H216-41400-087M4	H216-41400-087V4
	20	5.5	3.7	200 × 150 × 120	H216-41400-187N4	H216-41400-187M4	H216-41400-187V4
	25	7.5	5.5	150 × 150 × 120	H220-41400-087N4	H220-41400-087M4	H220-41400-087V4
	25	7.5	5.5	200 × 150 × 120	H220-41400-187N4	H220-41400-187M4	H220-41400-187V4
	32	11	7.5	150 × 150 × 120	H226-41400-087N4	H226-41400-087M4	H226-41400-087V4
	32	11	7.5	200 × 150 × 120	H226-41400-187N4	H226-41400-187M4	H226-41400-187V4
	40	15	11	200 × 150 × 120	H233-41400-187N4	H233-41400-187M4	H233-41400-187V4
	40	15	11	200 × 150 × 120	B240-41400-087N4*	B240-41400-087M4*	B240-41400-087V4*
	50	18.5	15	200 × 150 × 120	B250-41400-087N4	B250-41400-087M4	B250-41400-087V4
	63	22	18.5	200 × 150 × 120	B263-41400-087N4	B263-41400-087M4	B263-41400-087V4
	63	22	18.5	200 × 150 × 120	H406-41400-987N4*	H406-41400-987M4*	–
	63	22	18.5	300 × 250 × 150	H406-41400-187N4	H406-41400-187M4	–
	63	22	18.5	400 × 300 × 155	H406-41400-182N4¹	H406-41400-182M4¹	–
	80	30	22	200 × 150 × 120	H408-41400-987N4	H408-41400-987M4	–
	80	30	22	300 × 250 × 150	H408-41400-187N4	H408-41400-187M4	–
80	30	22	400 × 300 × 155	H408-41400-182N4¹	H408-41400-182M4¹	–	
100	37	30	300 × 250 × 150	H410-41400-187N4	H410-41400-187M4	–	
100	37	30	400 × 300 × 155	H410-41400-182N4¹	H410-41400-182M4¹	–	
125	45	37	300 × 250 × 150	H412-41400-187N4	H412-41400-187M4	–	
125	45	37	400 × 300 × 155	H412-41400-182N4¹	H412-41400-182M4¹	–	

Rated data (IEC 60947)			Enclosure dimension (H × W × D) (mm)	Padlock device H-handle yellow/red	
Operat. current I _e	Operational power (at 380–440 V)			 IP66	
AC-21A (A)	AC-23A (kW)	AC-3 (kW)		Order code number	
160	75	45	500 × 400 × 300	K616-41400-187H4¹	
315	132	55	600 × 400 × 300	K830-41400-187H4¹	
315	132	55	800 × 400 × 300	K830-41400-287H4¹	



* larger terminal capacity, see page 154

¹ hinged door

Further switching programmes from page 132.

Disconnect Switches

Main/Emergency-Off Switches Enclosed Switches – Mild Steel Enclosure

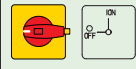
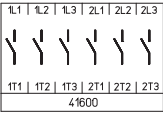
Switching programme	Rated data (IEC 60947)			Enclosure dimension (H × W × D) (mm)	Padlock device N-handle yellow/red	Padlock device M-handle yellow/red	Padlockable handle V-handle yellow/red
	Operat. current I _e	Operational power (at 380–440 V)			 IP66	 IP66	 IP66
	AC-21A (A)	AC-23A (kW)	AC-3 (kW)		Order code number	Order code number	Order code number
41600 – 6 pole – without auxiliary contacts 	20	5.5	3.7	200 × 150 × 120	H216-41600-187N4	H216-41600-187M4	H216-41600-187V4
	25	7.5	5.5	200 × 150 × 120	H220-41600-187N4	H220-41600-187M4	H220-41600-187V4
	32	11	7.5	200 × 150 × 120	H226-41600-187N4	H226-41600-187M4	H226-41600-187V4
	40	15	11	200 × 150 × 120	H233-41600-187N4	H233-41600-187M4	H233-41600-187V4
	40	15	11	300 × 250 × 150	B240-41600-187N4	B240-41600-187M4	–
	50	18.5	15	300 × 250 × 150	B250-41600-187N4	B250-41600-187M4	–
	63	22	18.5	300 × 250 × 150	B263-41600-187N4	B263-41600-187M4	–
	63	22	18.5	300 × 250 × 150	H406-41600-187N4*	H406-41600-187M4*	–
	63	22	18.5	400 × 300 × 155	H406-41600-182N4¹	H406-41600-182M4¹	–
	80	30	22	300 × 250 × 150	H408-41600-187N4	H408-41600-187M4	–
	80	30	22	400 × 300 × 155	H408-41600-182N4¹	H408-41600-182M4¹	–
	100	37	30	300 × 250 × 150	H410-41600-187N4	H410-41600-187M4	–
	100	37	30	400 × 300 × 155	H410-41600-182N4¹	H410-41600-182M4¹	–
	125	45	37	300 × 250 × 150	H412-41600-187N4	H412-41600-187M4	–
	125	45	37	400 × 300 × 155	H412-41600-182N4¹	H412-41600-182M4¹	–

Rated data (IEC 60947)			Enclosure dimension (H × W × D) (mm)	Padlock device H-handle yellow/red
Operat. current I _e	Operational power (at 380–440 V)			 IP66
AC-21A (A)	AC-23A (kW)	AC-3 (kW)		Order code number
160	75	45	500 × 400 × 300	K616-41600-187H4¹
315	132	55	600 × 400 × 300	K830-41600-187H4¹
315	132	55	800 × 400 × 300	K830-41600-287H4¹

* larger terminal capacity, see page 154

¹ hinged door

Further switching programmes from page 132.

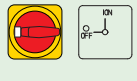
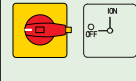
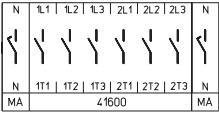
Switching programme	Rated data (IEC 60947)			Enclosure dimension (H × W × D) (mm)	Padlock device N-handle yellow/red	Padlock device M-handle yellow/red	Padlockable handle V-handle yellow/red
	Operat. current I _e	Operational power (at 380–440 V)			 IP66	 IP66	 IP66
	AC-21A (A)	AC-23A (kW)	AC-3 (kW)		Order code number	Order code number	Order code number
41800 – 8 pole – without auxiliary contacts – 2 neutral contacts early make/late break 	20	5.5	3.7	200 × 150 × 120	H216-41800-187N4	H216-41800-187M4	H216-41800-187V4
	25	7.5	5.5	200 × 150 × 120	H220-41800-187N4	H220-41800-187M4	H220-41800-187V4
	32	11	7.5	200 × 150 × 120	H226-41800-187N4	H226-41800-187M4	H226-41800-187V4
	40	15	11	200 × 150 × 120	H233-41800-187N4	H233-41800-187M4	H233-41800-187V4
	40	15	11	300 × 250 × 150	B240-41800-187N4	B240-41800-187M4	–
	50	18.5	15	300 × 250 × 150	B250-41800-187N4	B250-41800-187M4	–
	63	22	18.5	300 × 250 × 150	B263-41800-187N4	B263-41800-187M4	–
	63	22	18.5	300 × 250 × 150	H406-41800-187N4*	H406-41800-187M4*	–
	63	22	18.5	400 × 300 × 155	H406-41800-182N4¹	H406-41800-182M4¹	–
	80	30	22	300 × 250 × 150	H408-41800-187N4	H408-41800-187M4	–
	80	30	22	400 × 300 × 155	H408-41800-182N4¹	H408-41800-182M4¹	–
	100	37	30	300 × 250 × 150	H410-41800-187N4	H410-41800-187M4	–
	100	37	30	400 × 300 × 155	H410-41800-182N4¹	H410-41800-182M4¹	–
	125	45	37	300 × 250 × 150	H412-41800-187N4	H412-41800-187M4	–
	125	45	37	400 × 300 × 155	H412-41800-182N4¹	H412-41800-182M4¹	–

Rated data (IEC 60947)			Enclosure dimension (H × W × D) (mm)	Padlock device H-handle yellow/red
Operat. current I _e	Operational power (at 380–440 V)			 IP66
AC-21A (A)	AC-23A (kW)	AC-3 (kW)		Order code number
160	75	45	500 × 400 × 300	K616-41800-187H4¹
315	132	55	600 × 400 × 300	K830-41800-187H4¹
315	132	55	800 × 400 × 300	K830-41800-287H4¹

* larger terminal capacity, see page 154

¹ hinged door

Further switching programmes from page 132.

Disconnect Switches

Main/Emergency-Off Switches Enclosed Switches – Mild Steel Enclosure

Dimensions in mm:

Setup of order code number

Type	Switching progr.	Mtg. form
H216	41400	087M4
Order code no.	H216-41400-087M4	

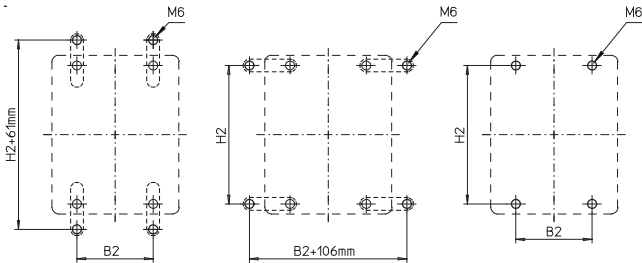
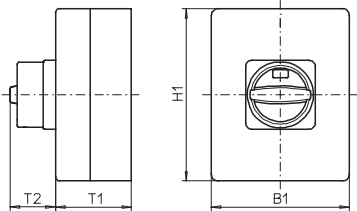

Please order mounting brackets separately, see page 148.

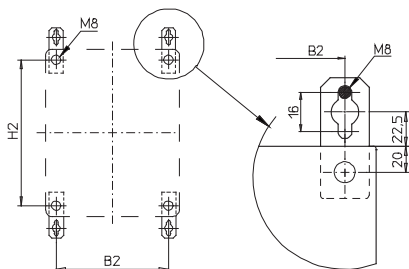
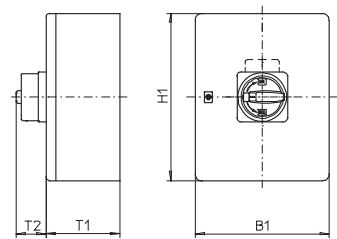

Please order mounting brackets separately, see page 148.

Mild steel enclosures **150 × 150 × 120 mm / 200 × 150 × 120 mm / 300 × 250 × 150 mm:**

Types H216 / H220 / H226 / H233:

Mtg. form	H1	B1	T1	T2	H2	B2
087M4	150	150	120	38	132	85
087N4	150	150	120	33	132	85
087V4	150	150	120	39	132	85
187M4	200	150	120	38	182	85
187N4	200	150	120	33	182	85
187V4	200	150	120	39	182	85

Types B240 / B250 / B263:

Mtg. form	H1	B1	T1	T2	H2	B2
087M4	200	150	120	38	182	85
087N4	200	150	120	33	182	85
087V4	200	150	120	39	182	85
187M4	300	250	150	50	282	185
187N4	300	250	150	45	282	185

Types H406 / H408 / H410 / H412:

Mtg. form	H1	B1	T1	T2	H2	B2
187M4	300	250	150	50	282	185
187N4	300	250	150	45	282	185
987M4	200	150	120	50	182	85
987N4	200	150	120	45	182	85

Mild steel enclosures **400 × 300 × 155 mm:**

Types H406 / H408 / H410 / H412:

Mtg. form	H1	B1	T1	T2	H2	B2
182M4	400	300	155	50	360	260
182N4	400	300	155	45	360	260

Gland plate at the bottom

Dimensions in mm:

Setup of order code number

Type	Switching progr.	Mtg. form
K616	41300	187H4
Order code no.	K616-41300-187H4	

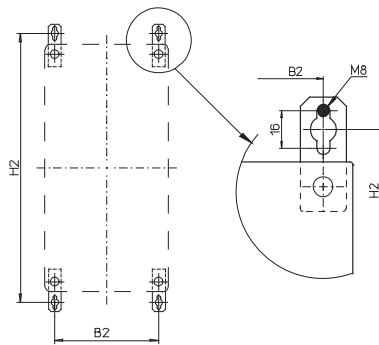
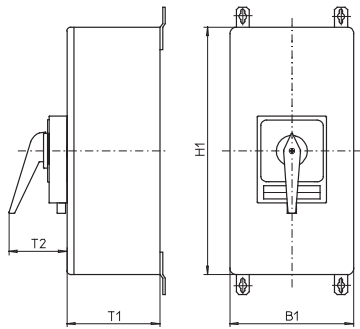

Mounting brackets are included.

Mild steel enclosures **500 × 400 × 300 mm / 600 × 400 × 300 mm / 800 × 400 × 300 mm:**

Type K616:

Mtg. form	H1	B1	T1	T2	H2	B2
187H4	500	400	300	83	545	360

Type K830:

Mtg. form	H1	B1	T1	T2	H2	B2
187H4	600	400	300	93	645	360
287H4	800	400	300	93	845	360

Further switching programmes and corresponding dimensions for types K on request.

Gland plate at the bottom



Disconnect Switches

Main/Emergency-Off Switches Enclosed Switches – Stainless Steel Enclosure

Main/Emergency-Off Switches

- Enclosed switches with stainless steel enclosure (brushed)
- Cover interlock in ON position
- 3 up to 8 pole
- 20 A up to 125 A
- IP66

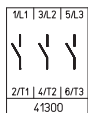
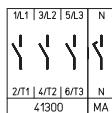

Switching programme	Rated data (IEC 60947)			Enclosure dimension (H × W × D) (mm)	Padlock device N-handle yellow/red	Padlock device M-handle yellow/red	Padlockable handle V-handle yellow/red
	Operat. current I _e (A)	Operational power (at 380–440 V) (kW)			 IP66	 IP66	 IP66
	AC-21A (A)	AC-23A (kW)	AC-3 (kW)		Order code number	Order code number	Order code number
41300 – 3 pole – without auxiliary contacts 	20	5.5	3.7	150 × 150 × 120	H216-41300-097N4	H216-41300-097M4	H216-41300-097V4
	20	5.5	3.7	200 × 150 × 120	H216-41300-197N4	H216-41300-197M4	H216-41300-197V4
	25	7.5	5.5	150 × 150 × 120	H220-41300-097N4	H220-41300-097M4	H220-41300-097V4
	25	7.5	5.5	200 × 150 × 120	H220-41300-197N4	H220-41300-197M4	H220-41300-197V4
	32	11	7.5	150 × 150 × 120	H226-41300-097N4	H226-41300-097M4	H226-41300-097V4
	32	11	7.5	200 × 150 × 120	H226-41300-197N4	H226-41300-197M4	H226-41300-197V4
	40	15	11	200 × 150 × 120	H233-41300-197N4	H233-41300-197M4	H233-41300-197V4
	40	15	11	200 × 150 × 120	B240-41300-097N4*	B240-41300-097M4*	B240-41300-097V4*
	50	18.5	15	200 × 150 × 120	B250-41300-097N4	B250-41300-097M4	B250-41300-097V4
	63	22	18.5	200 × 150 × 120	B263-41300-097N4	B263-41300-097M4	B263-41300-097V4
	63	22	18.5	200 × 150 × 120	H406-41300-997N4*	H406-41300-997M4*	–
	63	22	18.5	300 × 250 × 150	H406-41300-197N4	H406-41300-197M4	–
	80	30	22	200 × 150 × 120	H408-41300-997N4	H408-41300-997M4	–
	80	30	22	300 × 250 × 150	H408-41300-197N4	H408-41300-197M4	–
100	37	30	300 × 250 × 150	H410-41300-197N4	H410-41300-197M4	–	
125	45	37	300 × 250 × 150	H412-41300-197N4	H412-41300-197M4	–	
41400 – 4 pole – without auxiliary contacts – neutral contact early make/late break 	20	5.5	3.7	150 × 150 × 120	H216-41400-097N4	H216-41400-097M4	H216-41400-097V4
	20	5.5	3.7	200 × 150 × 120	H216-41400-197N4	H216-41400-197M4	H216-41400-197V4
	25	7.5	5.5	150 × 150 × 120	H220-41400-097N4	H220-41400-097M4	H220-41400-097V4
	25	7.5	5.5	200 × 150 × 120	H220-41400-197N4	H220-41400-197M4	H220-41400-197V4
	32	11	7.5	150 × 150 × 120	H226-41400-097N4	H226-41400-097M4	H226-41400-097V4
	32	11	7.5	200 × 150 × 120	H226-41400-197N4	H226-41400-197M4	H226-41400-197V4
	40	15	11	200 × 150 × 120	H233-41400-197N4	H233-41400-197M4	H233-41400-197V4
	40	15	11	200 × 150 × 120	B240-41400-097N4*	B240-41400-097M4*	B240-41400-097V4*
	50	18.5	15	200 × 150 × 120	B250-41400-097N4	B250-41400-097M4	B250-41400-097V4
	63	22	18.5	200 × 150 × 120	B263-41400-097N4	B263-41400-097M4	B263-41400-097V4
	63	22	18.5	200 × 150 × 120	H406-41400-997N4*	H406-41400-997M4*	–
	63	22	18.5	300 × 250 × 150	H406-41400-197N4	H406-41400-197M4	–
	80	30	22	200 × 150 × 120	H408-41400-997N4	H408-41400-997M4	–
	80	30	22	300 × 250 × 150	H408-41400-197N4	H408-41400-197M4	–
100	37	30	300 × 250 × 150	H410-41400-197N4	H410-41400-197M4	–	
125	45	37	300 × 250 × 150	H412-41400-197N4	H412-41400-197M4	–	

* larger terminal capacity, see page 154

Further switching programmes from page 132.

Disconnect Switches



Main/Emergency-Off Switches Enclosed Switches – Stainless Steel Enclosure

Switching programme	Rated data (IEC 60947)			Enclosure dimension (H × W × D) (mm)	Padlock device N-handle yellow/red	Padlock device M-handle yellow/red	Padlockable handle V-handle yellow/red
	Operat. current I _e	Operational power (at 380–440 V)			IP66	IP66	IP66
	AC-21A (A)	AC-23A (kW)	AC-3 (kW)		Order code number	Order code number	Order code number
41600 – 6 pole – without auxiliary contacts 	20	5.5	3.7	200 × 150 × 120	H216-41600-197N4	H216-41600-197M4	H216-41600-197V4
	25	7.5	5.5	200 × 150 × 120	H220-41600-197N4	H220-41600-197M4	H220-41600-197V4
	32	11	7.5	200 × 150 × 120	H226-41600-197N4	H226-41600-197M4	H226-41600-197V4
	40	15	11	200 × 150 × 120	H233-41600-197N4	H233-41600-197M4	H233-41600-197V4
	40	15	11	300 × 250 × 150	B240-41600-197N4	B240-41600-197M4	–
	50	18.5	15	300 × 250 × 150	B250-41600-197N4	B250-41600-197M4	–
	63	22	18.5	300 × 250 × 150	B263-41600-197N4	B263-41600-197M4	–
	63	22	18.5	300 × 250 × 150	H406-41600-197N4*	H406-41600-197M4*	–
	80	30	22	300 × 250 × 150	H408-41600-197N4	H408-41600-197M4	–
	100	37	30	300 × 250 × 150	H410-41600-197N4	H410-41600-197M4	–
125	45	37	300 × 250 × 150	H412-41600-197N4	H412-41600-197M4	–	
41800 – 8 pole – without auxiliary contacts – 2 neutral contacts early make/late break 	20	5.5	3.7	200 × 150 × 120	H216-41800-197N4	H216-41800-197M4	H216-41800-197V4
	25	7.5	5.5	200 × 150 × 120	H220-41800-197N4	H220-41800-197M4	H220-41800-197V4
	32	11	7.5	200 × 150 × 120	H226-41800-197N4	H226-41800-197M4	H226-41800-197V4
	40	15	11	200 × 150 × 120	H233-41800-197N4	H233-41800-197M4	H233-41800-197V4
	40	15	11	300 × 250 × 150	B240-41800-197N4	B240-41800-197M4	–
	50	18.5	15	300 × 250 × 150	B250-41800-197N4	B250-41800-197M4	–
	63	22	18.5	300 × 250 × 150	B263-41800-197N4	B263-41800-197M4	–
	63	22	18.5	300 × 250 × 150	H406-41800-197N4*	H406-41800-197M4*	–
	80	30	22	300 × 250 × 150	H408-41800-197N4	H408-41800-197M4	–
	100	37	30	300 × 250 × 150	H410-41800-197N4	H410-41800-197M4	–
125	45	37	300 × 250 × 150	H412-41800-197N4	H412-41800-197M4	–	

* larger terminal capacity, see page 154

Further switching programmes from page 132.

Dimensions in mm:

Setup of order code number

Type	Switching progr.	Mtg. form
B263	41800	197V4
Order code no.	B263-41800-197V4	

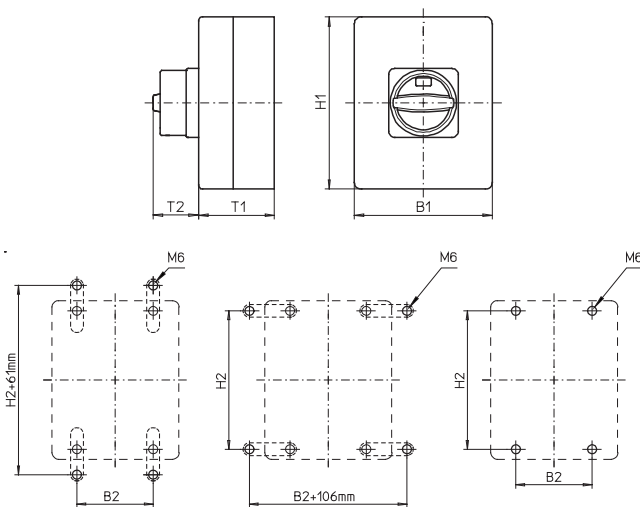

Please order mounting brackets separately, see page 148.

Types H216 / H220 / H226 / H233:

Mtg. form	H1	B1	T1	T2	H2	B2
097M4	150	150	120	38	132	85
097N4	150	150	120	33	132	85
097V4	150	150	120	39	132	85
197M4	200	150	120	38	182	85
197N4	200	150	120	33	182	85
197V4	200	150	120	39	182	85

Types B240 / B250 / B263:

Mtg. form	H1	B1	T1	T2	H2	B2
097M4	200	150	120	38	182	85
097N4	200	150	120	33	182	85
097V4	200	150	120	39	182	85
197M4	300	250	150	50	282	185
197N4	300	250	150	45	282	185

Types H406 / H408 / H410 / H412:

Mtg. form	H1	B1	T1	T2	H2	B2
197M4	300	250	150	50	282	185
197N4	300	250	150	45	282	185
997M4	200	150	120	50	182	85
997N4	200	150	120	45	182	85



Disconnect Switches

Main Switches Front mounting Four hole mounting

Main Switches

- Front mounting switches with four hole mounting
- 3 up to 8 pole
- 20 A up to 315 A
- IP66 / IP55

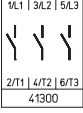

Switching programme	Rated data (IEC 60947)			Mounting dimension (mm)	Padlock device N-handle black	Padlock device M-handle black	Padlockable handle V-handle silver/black
	Operat. current I_e	Operational power (at 380–440 V)			 OFF-ON	 ON	 ON
	AC-21A (A)	AC-23A (kW)	AC-3 (kW)		IP66	IP66	IP66
					Order code number	Order code number	Order code number
41300 – 3 pole – without auxiliary contacts 	20	5.5	3.7	36 × 36	H216-41300-033N1	H216-41300-033M1	H216-41300-033V1
	20	5.5	3.7	48 × 48	H216-41300-036N1	H216-41300-036M1	H216-41300-036V1
	25	7.5	5.5	36 × 36	H220-41300-033N1	H220-41300-033M1	H220-41300-033V1
	25	7.5	5.5	48 × 48	H220-41300-036N1	H220-41300-036M1	H220-41300-036V1
	32	11	7.5	36 × 36	H226-41300-033N1	H226-41300-033M1	H226-41300-033V1
	32	11	7.5	48 × 48	H226-41300-036N1	H226-41300-036M1	H226-41300-036V1
	40	15	11	36 × 36	H233-41300-033N1	H233-41300-033M1	H233-41300-033V1
	40	15	11	36 × 36	B240-41300-033N1*	B240-41300-033M1*	B240-41300-033V1*
	40	15	11	48 × 48	H233-41300-036N1	H233-41300-036M1	H233-41300-036V1
	40	15	11	48 × 48	B240-41300-036N1*	B240-41300-036M1*	B240-41300-036V1*
	40	15	11	68 × 68	B240-41300-136N1	B240-41300-136M1	–
	50	18.5	15	36 × 36	B250-41300-033N1	B250-41300-033M1	B250-41300-033V1
	50	18.5	15	48 × 48	B250-41300-036N1	B250-41300-036M1	B250-41300-036V1
	50	18.5	15	68 × 68	B250-41300-136N1	B250-41300-136M1	–
	63	22	18.5	36 × 36	B263-41300-033N1	B263-41300-033M1	B263-41300-033V1
	63	22	18.5	48 × 48	B263-41300-036N1	B263-41300-036M1	B263-41300-036V1
	63	22	18.5	48 × 48	H406-41300-033N1*	H406-41300-033M1*	H406-41300-033V1*
	63	22	18.5	68 × 68	B263-41300-136N1	B263-41300-136M1	–
	63	22	18.5	68 × 68	H406-41300-036N1*	H406-41300-036M1*	–
	80	30	22	48 × 48	H408-41300-033N1	H408-41300-033M1	H408-41300-033V1
80	30	22	68 × 68	H408-41300-036N1	H408-41300-036M1	–	
100	37	30	48 × 48	H410-41300-033N1	H410-41300-033M1	H410-41300-033V1	
100	37	30	68 × 68	H410-41300-036N1	H410-41300-036M1	–	
125	45	37	48 × 48	H412-41300-033N1	H412-41300-033M1	H412-41300-033V1	
125	45	37	68 × 68	H412-41300-036N1	H412-41300-036M1	–	

Rated data (IEC 60947)			Mounting dimension (mm)	Padlock device H-handle silver/black
Operat. current I_e	Operational power (at 380–440 V)			 ON
AC-21A (A)	AC-23A (kW)	AC-3 (kW)		IP55
				Order code number
160	75	45	68 × 68	K616-41300-033H1
315	132	55	104 × 104	K830-41300-033H1







* larger terminal capacity, see page 154



Further switching programmes from page 132.

Disconnect Switches

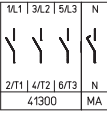

Main Switches Front mounting Four hole mounting

Switching programme	Rated data (IEC 60947)			Mounting dimension (mm)	Padlock device N-handle black	Padlock device M-handle black	Padlockable handle V-handle silver/black
	Operat. current I_e AC-21A (A)	Operational power (at 380–440 V) AC-23A (kW)	AC-3 (kW)		 	 	 
					IP66	IP66	IP66
				Order code number	Order code number	Order code number	
41400 – 4 pole – without auxiliary contacts – neutral contact early make/late break 	20	5.5	3.7	36 × 36	H216-41400-033N1	H216-41400-033M1	H216-41400-033V1
	20	5.5	3.7	48 × 48	H216-41400-036N1	H216-41400-036M1	H216-41400-036V1
	25	7.5	5.5	36 × 36	H220-41400-033N1	H220-41400-033M1	H220-41400-033V1
	25	7.5	5.5	48 × 48	H220-41400-036N1	H220-41400-036M1	H220-41400-036V1
	32	11	7.5	36 × 36	H226-41400-033N1	H226-41400-033M1	H226-41400-033V1
	32	11	7.5	48 × 48	H226-41400-036N1	H226-41400-036M1	H226-41400-036V1
	40	15	11	36 × 36	H233-41400-033N1	H233-41400-033M1	H233-41400-033V1
	40	15	11	36 × 36	B240-41400-033N1*	B240-41400-033M1*	B240-41400-033V1*
	40	15	11	48 × 48	H233-41400-036N1	H233-41400-036M1	H233-41400-036V1
	40	15	11	48 × 48	B240-41400-036N1*	B240-41400-036M1*	B240-41400-036V1*
	40	15	11	68 × 68	B240-41400-136N1	B240-41400-136M1	–
	50	18.5	15	36 × 36	B250-41400-033N1	B250-41400-033M1	B250-41400-033V1
	50	18.5	15	48 × 48	B250-41400-036N1	B250-41400-036M1	B250-41400-036V1
	50	18.5	15	68 × 68	B250-41400-136N1	B250-41400-136M1	–
	63	22	18.5	36 × 36	B263-41400-033N1	B263-41400-033M1	B263-41400-033V1
	63	22	18.5	48 × 48	B263-41400-036N1	B263-41400-036M1	B263-41400-036V1
	63	22	18.5	48 × 48	H406-41400-033N1*	H406-41400-033M1*	H406-41400-033V1*
	63	22	18.5	68 × 68	B263-41400-136N1	B263-41400-136M1	–
	63	22	18.5	68 × 68	H406-41400-036N1*	H406-41400-036M1*	–
	80	30	22	48 × 48	H408-41400-033N1	H408-41400-033M1	H408-41400-033V1
80	30	22	68 × 68	H408-41400-036N1	H408-41400-036M1	–	
100	37	30	48 × 48	H410-41400-033N1	H410-41400-033M1	H410-41400-033V1	
100	37	30	68 × 68	H410-41400-036N1	H410-41400-036M1	–	
125	45	37	48 × 48	H412-41400-033N1	H412-41400-033M1	H412-41400-033V1	
125	45	37	68 × 68	H412-41400-036N1	H412-41400-036M1	–	



Rated data (IEC 60947)			Mounting dimension (mm)	Padlock device H-handle silver/black
Operat. current I_e AC-21A (A)	Operational power (at 380–440 V) AC-23A (kW)	AC-3 (kW)		 
			IP55	
			Order code number	
160	75	45	68 × 68	K616-41400-033H1
315	132	55	104 × 104	K830-41400-033H1

* larger terminal capacity, see page 154

Further switching programmes from page 132.

Disconnect Switches

Main Switches Front mounting Four hole mounting

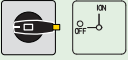
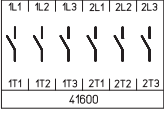
Switching programme	Rated data (IEC 60947)			Mounting dimension (mm)	Padlock device N-handle black	Padlock device M-handle black	Padlockable handle V-handle silver/black
	Operat. current I_e	Operational power (at 380–440 V)					
		AC-21A (A)	AC-23A (kW)		AC-3 (kW)	IP66	IP66
				Order code number	Order code number	Order code number	
41600 – 6 pole – without auxiliary contacts 	20	5.5	3.7	36 × 36	H216-41600-033N1	H216-41600-033M1	–
	20	5.5	3.7	48 × 48	H216-41600-036N1	H216-41600-036M1	H216-41600-036V1
	20	5.5	3.7	68 × 68	H216-41600-136N1	H216-41600-136M1	–
	25	7.5	5.5	36 × 36	H220-41600-033N1	H220-41600-033M1	–
	25	7.5	5.5	48 × 48	H220-41600-036N1	H220-41600-036M1	H220-41600-036V1
	25	7.5	7.5	68 × 68	H220-41600-136N1	H220-41600-136M1	–
	32	11	7.5	36 × 36	H226-41600-033N1	H226-41600-033M1	–
	32	11	7.5	48 × 48	H226-41600-036N1	H226-41600-036M1	H226-41600-036V1
	32	11	7.5	68 × 68	H226-41600-136N1	H226-41600-136M1	–
	40	15	11	36 × 36	H233-41600-033N1	H233-41600-033M1	–
	40	15	11	36 × 36	B240-41600-033N1*	B240-41600-033M1*	–
	40	15	11	48 × 48	H233-41600-036N1	H233-41600-036M1	H233-41600-036V1
	40	15	11	48 × 48	B240-41600-036N1*	B240-41600-036M1*	B240-41600-036V1
	40	15	11	68 × 68	H233-41600-136N1	H233-41600-136M1	–
	40	15	11	68 × 68	B240-41600-136N1*	B240-41600-136M1*	–
	50	18.5	15	36 × 36	B250-41600-033N1	B250-41600-033M1	–
	50	18.5	15	48 × 48	B250-41600-036N1	B250-41600-036M1	B250-41600-036V1
	50	18.5	15	68 × 68	B250-41600-136N1	B250-41600-136M1	–
	63	22	18.5	36 × 36	B263-41600-033N1	B263-41600-033M1	–
	63	22	18.5	48 × 48	B263-41600-036N1	B263-41600-036M1	B263-41600-036V1
	63	22	18.5	48 × 48	H406-41600-033N1*	H406-41600-033M1*	H406-41600-033V1*
	63	22	18.5	68 × 68	B263-41600-136N1	B263-41600-136M1	–
	63	22	18.5	68 × 68	H406-41600-036N1*	H406-41600-036M1*	–
	80	30	22	48 × 48	H408-41600-033N1	H408-41600-033M1	H408-41600-033V1
80	30	22	68 × 68	H408-41600-036N1	H408-41600-036M1	–	
100	37	30	48 × 48	H410-41600-033N1	H410-41600-033M1	H410-41600-033V1	
100	37	30	68 × 68	H410-41600-036N1	H410-41600-036M1	–	
125	45	37	48 × 48	H412-41600-033N1	H412-41600-033M1	H412-41600-033V1	
125	45	37	68 × 68	H412-41600-036N1	H412-41600-036M1	–	

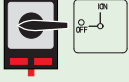
Rated data (IEC 60947)			Mounting dimension (mm)	Padlock device H-handle silver/black
Operat. current I_e	Operational power (at 380–440 V)			
AC-21A (A)	AC-23A (kW)	AC-3 (kW)		IP55
			Order code number	
160	75	45	68 × 68	K616-41600-033H1
315	132	55	104 × 104	K830-41600-033H1

* larger terminal capacity, see page 154

Further switching programmes from page 132.

Disconnect Switches



Main Switches Front mounting Four hole mounting

Switching programme	Rated data (IEC 60947)			Mounting dimension (mm)	Padlock device N-handle black	Padlock device M-handle black	Padlockable handle V-handle silver/black	
	Operat. current I_e				IP66		IP66	IP66
	Operational power (at 380–440 V)							
	AC-21A (A)	AC-23A (kW)	AC-3 (kW)		Order code number	Order code number	Order code number	
41800 – 8 pole – without auxiliary contacts – 2 neutral contacts early make/late break 	20	5.5	3.7	36 × 36	H216-41800-033N1	H216-41800-033M1	–	
	20	5.5	3.7	48 × 48	H216-41800-036N1	H216-41800-036M1	H216-41800-036V1	
	20	5.5	3.7	68 × 68	H216-41800-136N1	H216-41800-136M1	–	
	25	7.5	5.5	36 × 36	H220-41800-033N1	H220-41800-033M1	–	
	25	7.5	5.5	48 × 48	H220-41800-036N1	H220-41800-036M1	H220-41800-036V1	
	25	7.5	5.5	68 × 68	H220-41800-136N1	H220-41800-136M1	–	
	32	11	7.5	36 × 36	H226-41800-033N1	H226-41800-033M1	–	
	32	11	7.5	48 × 48	H226-41800-036N1	H226-41800-036M1	H226-41800-036V1	
	32	11	7.5	68 × 68	H226-41800-136N1	H226-41800-136M1	–	
	40	15	11	36 × 36	H233-41800-033N1	H233-41800-033M1	–	
	40	15	11	36 × 36	B240-41800-033N1*	B240-41800-033M1*	–	
	40	15	11	48 × 48	H233-41800-036N1	H233-41800-036M1	H233-41800-036V1	
	40	15	11	48 × 48	B240-41800-036N1*	B240-41800-036M1*	B240-41800-036V1*	
	40	15	11	68 × 68	H233-41800-136N1	H233-41800-136M1	–	
	40	15	11	68 × 68	B240-41800-136N1*	B240-41800-136M1*	–	
	50	18.5	15	36 × 36	B250-41800-033N1	B250-41800-033M1	–	
	50	18.5	15	48 × 48	B250-41800-036N1	B250-41800-036M1	B250-41800-036V1	
	50	18.5	15	68 × 68	B250-41800-136N1	B250-41800-136M1	–	
	63	22	18.5	36 × 36	B263-41800-033N1	B263-41800-033M1	–	
	63	22	18.5	48 × 48	B263-41800-036N1	B263-41800-036M1	B263-41800-036V1	
63	22	18.5	48 × 48	H406-41800-033N1*	H406-41800-033M1*	H406-41800-033V1*		
63	22	18.5	68 × 68	B263-41800-136N1	B263-41800-136M1	–		
63	22	18.5	68 × 68	H406-41800-036N1*	H406-41800-036M1*	–		
80	30	22	48 × 48	H408-41800-033N1	H408-41800-033M1	H408-41800-033V1		
80	30	22	68 × 68	H408-41800-036N1	H408-41800-036M1	–		
100	37	30	48 × 48	H410-41800-033N1	H410-41800-033M1	H410-41800-033V1		
100	37	30	68 × 68	H410-41800-036N1	H410-41800-036M1	–		
125	45	37	48 × 48	H412-41800-033N1	H412-41800-033M1	H412-41800-033V1		
125	45	37	68 × 68	H412-41800-036N1	H412-41800-036M1	–		

Rated data (IEC 60947)			Mounting dimension (mm)	Padlock device H-handle silver/black	
Operat. current I_e				IP55	
Operational power (at 380–440 V)					
	AC-21A (A)	AC-23A (kW)	AC-3 (kW)	Order code number	
	160	75	45	68 × 68	K616-41800-033H1
	315	132	55	104 × 104	K830-41800-033H1

* larger terminal capacity, see page 154

Further switching programmes from page 132.

Disconnect Switches

Main Switches Front mounting Four hole mounting

Dimensions in mm:

Setup of order code number		
Type	Switching progr.	Mtg. form
H216	41800	036N1
Order code no.	H216-41800-036N1	

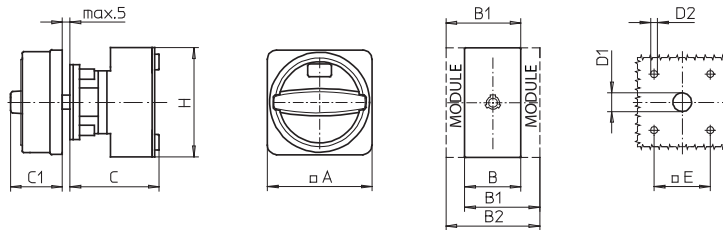

Switching programmes 3 and 4 pole

Types H216 / H220 / H226 / H233:

Mtg. form	A	B	B1	B2	C	C1	D1	D2	E	H
033M1	67	36	48	60	58	38	15	4.5	36	70
033N1	67	36	48	60	58	33	15	4.5	36	70
033V1	48	36	48	60	58	32	12	4.5	36	70
036M1	67	36	48	60	58	38	15	5	48	70
036N1	67	36	48	60	58	33	15	5	48	70
036V1	64	36	48	60	58	39	15	5	48	70

Types B240 / B250 / B263:

Mtg. form	A	B	B1	B2	C	C1	D1	D2	E	H
033M1	67	50	69	88	58	38	15	4.5	36	72
033N1	67	50	69	88	58	33	15	4.5	36	72
033V1	48	50	69	88	58	32	12	4.5	36	72
036M1	67	50	69	88	58	38	15	5	48	72
036N1	67	50	69	88	58	33	15	5	48	72
036V1	64	50	69	88	58	39	15	5	48	72
136M1	88	50	69	88	58	50	15	5.5	68	72
136N1	88	50	69	88	58	45	15	5.5	68	72

Types H406 / H408 / H410 / H412:

Mtg. form	A	B	B1	B2	C	C1	D1	D2	E	H
033M1	88	70	89	108	73	50	15	5	48	80
033N1	88	70	89	108	73	45	15	5	48	80
033V1	64	70	89	108	73	39	15	5	48	80
036M1	88	70	89	108	73	50	15	5.5	68	80
036N1	88	70	89	108	73	45	15	5.5	68	80

Switching programmes 6 and 8 pole

Types H216 / H220 / H226 / H233:

Mtg. form	A	B	B1	B2	C	C1	D1	D2	E	H
033M1	67	72	84	96	66	38	15	4.5	36	70
033N1	67	72	84	96	66	33	15	4.5	36	70
036M1	67	72	84	96	66	38	15	5	48	70
036N1	67	72	84	96	66	33	15	5	48	70
036V1	64	72	84	96	66	39	15	5	48	70
136M1	88	72	84	96	66	38	15	5.5	68	70
136N1	88	72	84	96	66	33	15	5.5	68	70

Types B240 / B250 / B263:

Mtg. form	A	B	B1	B2	C	C1	D1	D2	E	H
033M1	67	100	119	138	70	38	15	4.5	36	72
033N1	67	100	119	138	70	33	15	4.5	36	72
036M1	67	100	119	138	70	38	15	5	48	72
036N1	67	100	119	138	70	33	15	5	48	72
036V1	64	100	119	138	70	39	15	5	48	72
136M1	88	100	119	138	70	50	15	5.5	68	72
136N1	88	100	119	138	70	45	15	5.5	68	72

Types H406 / H408 / H410 / H412:

Mtg. form	A	B	B1	B2	C	C1	D1	D2	E	H
033M1	88	140	159	178	86	50	15	5	48	80
033N1	88	140	159	178	86	45	15	5	48	80
033V1	64	140	159	178	86	39	15	5	48	80
036M1	88	140	159	178	86	50	15	5.5	68	80
036N1	88	140	159	178	86	45	15	5.5	68	80

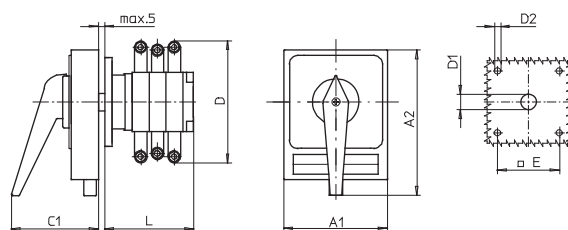

Types K616 / K830:

Type	Mtg. form	Switching progr.	A1	A2	C1	D*	D1	D2	E	L
K616	033H1	41300	98	142	83	150	20	5.5	68	104
K616	033H1	41400	98	142	83	150	20	5.5	68	104
K830	033H1	41300	130	178	93	210	20	5.5	104	125
K830	033H1	41400	130	178	93	210	20	5.5	104	125

Types K616 / K830:

Type	Mtg. form	Switching progr.	A1	A2	C1	D*	D1	D2	E	L
K616	033H1	41600	98	142	83	150	20	5.5	68	136
K616	033H1	41800	98	142	83	150	20	5.5	68	168
K830	033H1	41600	130	178	93	210	20	5.5	104	161
K830	033H1	41800	130	178	93	210	20	5.5	104	197



Further switching programmes and corresponding dimensions for types K on request.

* terminal lugs included

Main Switches

- Front mounting switches with single hole mounting
- 3 up to 8 pole
- 20 A up to 63 A
- IP66



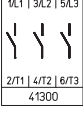
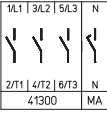

Switching programme	Rated data (IEC 60947)			Mounting dimension (mm)	Padlock device N-handle black	Padlock device M-handle black	Padlockable handle V-handle silver/black
	Operat. current I_e	Operational power (at 380–440 V)			 OFF-ON	 OFF-ON	 OFF-ON
	AC-21A (A)	AC-23A (kW)	AC-3 (kW)		IP66	IP66	IP66
					Order code number	Order code number	Order code number
41300 – 3 pole – without auxiliary contacts 	20	5.5	3.7	∅ 22.5	H216-41300-206N1	H216-41300-206M1	H216-41300-206V1
	20	5.5	3.7	∅ 30.5	H216-41300-216N1	H216-41300-216M1	H216-41300-216V1
	25	7.5	5.5	∅ 22.5	H220-41300-206N1	H220-41300-206M1	H220-41300-206V1
	25	7.5	5.5	∅ 30.5	H220-41300-216N1	H220-41300-216M1	H220-41300-216V1
	32	11	7.5	∅ 22.5	H226-41300-206N1	H226-41300-206M1	H226-41300-206V1
	32	11	7.5	∅ 30.5	H226-41300-216N1	H226-41300-216M1	H226-41300-216V1
	40	15	11	∅ 22.5	H233-41300-206N1	H233-41300-206M1	H233-41300-206V1
	40	15	11	∅ 22.5	B240-41300-206N1*	B240-41300-206M1*	B240-41300-206V1*
	40	15	11	∅ 30.5	H233-41300-216N1	H233-41300-216M1	H233-41300-216V1
	40	15	11	∅ 30.5	B240-41300-216N1*	B240-41300-216M1*	B240-41300-216V1*
	50	18.5	15	∅ 22.5	B250-41300-206N1	B250-41300-206M1	B250-41300-206V1
	50	18.5	15	∅ 30.5	B250-41300-216N1	B250-41300-216M1	B250-41300-216V1
	63	22	18.5	∅ 22.5	B263-41300-206N1	B263-41300-206M1	B263-41300-206V1
	63	22	18.5	∅ 30.5	B263-41300-216N1	B263-41300-216M1	B263-41300-216V1
41400 – 4 pole – without auxiliary contacts – neutral contact early make/late break 	20	5.5	3.7	∅ 22.5	H216-41400-206N1	H216-41400-206M1	H216-41400-206V1
	20	5.5	3.7	∅ 30.5	H216-41400-216N1	H216-41400-216M1	H216-41400-216V1
	25	7.5	5.5	∅ 22.5	H220-41400-206N1	H220-41400-206M1	H220-41400-206V1
	25	7.5	5.5	∅ 30.5	H220-41400-216N1	H220-41400-216M1	H220-41400-216V1
	32	11	7.5	∅ 22.5	H226-41400-206N1	H226-41400-206M1	H226-41400-206V1
	32	11	7.5	∅ 30.5	H226-41400-216N1	H226-41400-216M1	H226-41400-216V1
	40	15	11	∅ 22.5	H233-41400-206N1	H233-41400-206M1	H233-41400-206V1
	40	15	11	∅ 22.5	B240-41400-206N1*	B240-41400-206M1*	B240-41400-206V1*
	40	15	11	∅ 30.5	H233-41400-216N1	H233-41400-216M1	H233-41400-216V1
	40	15	11	∅ 30.5	B240-41400-216N1*	B240-41400-216M1*	B240-41400-216V1*
	50	18.5	15	∅ 22.5	B250-41400-206N1	B250-41400-206M1	B250-41400-206V1
	50	18.5	15	∅ 30.5	B250-41400-216N1	B250-41400-216M1	B250-41400-216V1
	63	22	18.5	∅ 22.5	B263-41400-206N1	B263-41400-206M1	B263-41400-206V1
	63	22	18.5	∅ 30.5	B263-41400-216N1	B263-41400-216M1	B263-41400-216V1

* larger terminal capacity, see page 154

Further switching programmes from page 132.

Disconnect Switches

Main Switches Front mounting Single hole mounting

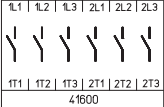
Switching programme	Rated data (IEC 60947)			Mounting dimension (mm)	Padlock device N-handle black	Padlock device M-handle black	Padlockable handle V-handle silver/black
	Operat. current I_e (A)	Operational power current (at 380–440 V)					
		AC-21A	AC-23A		AC-3	IP66	IP66
41600 – 6 pole – without auxiliary contacts 	20	5.5	3.7	∅ 22.5	H216-41600-206N1	H216-41600-206M1	–
	20	5.5	3.7	∅ 30.5	H216-41600-216N1	H216-41600-216M1	H216-41600-216V1
	25	7.5	5.5	∅ 22.5	H220-41600-206N1	H220-41600-206M1	–
	25	7.5	5.5	∅ 30.5	H220-41600-216N1	H220-41600-216M1	H220-41600-216V1
	32	11	7.5	∅ 22.5	H226-41600-206N1	H226-41600-206M1	–
	32	11	7.5	∅ 30.5	H226-41600-216N1	H226-41600-216M1	H226-41600-216V1
	40	15	11	∅ 22.5	H233-41600-206N1	H233-41600-206M1	–
	40	15	11	∅ 30.5	H233-41600-216N1	H233-41600-216M1	H233-41600-216V1

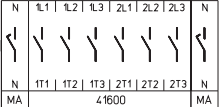
41800 – 8 pole – without auxiliary contacts – 2 neutral contacts early make/late break 	20	5.5	3.7	∅ 22.5	H216-41800-206N1	H216-41800-206M1	–
	20	5.5	3.7	∅ 30.5	H216-41800-216N1	H216-41800-216M1	H216-41800-216V1
	25	7.5	5.5	∅ 22.5	H220-41800-206N1	H220-41800-206M1	–
	25	7.5	5.5	∅ 30.5	H220-41800-216N1	H220-41800-216M1	H220-41800-216V1
	32	11	7.5	∅ 22.5	H226-41800-206N1	H226-41800-206M1	–
	32	11	7.5	∅ 30.5	H226-41800-216N1	H226-41800-216M1	H226-41800-216V1
	40	15	11	∅ 22.5	H233-41800-206N1	H233-41800-206M1	–
	40	15	11	∅ 30.5	H233-41800-216N1	H233-41800-216M1	H233-41800-216V1

Further switching programmes from page 132.

Dimensions in mm:

Setup of order code number		
Type	Switching progr.	Mtg. form
H226	41300	206N1
Order code no.	H226-41300-206N1	

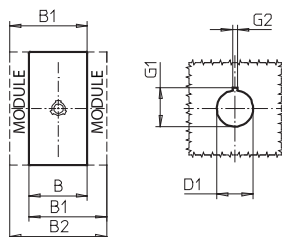
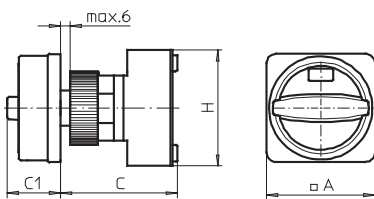

Switching programmes 3 and 4 pole

Types H216 / H220 / H226 / H233:

Mtg. form	A	B	B1	B2	C	C1	D1	G1	G2	H
206M1	67	36	48	60	75	38	22.5	24.2	3.2	70
206N1	67	36	48	60	75	33	22.5	24.2	3.2	70
206V1	48	36	48	60	75	32	22.5	24.2	3.2	70
216M1	67	36	48	60	75	38	30.5	33	4.8	70
216N1	67	36	48	60	75	33	30.5	33	4.8	70
216V1	64	36	48	60	75	39	30.5	33	4.8	70

Types B240 / B250 / B263:

Mtg. form	A	B	B1	B2	C	C1	D1	G1	G2	H
206M1	67	50	69	88	75	38	22.5	24.2	3.2	72
206N1	67	50	69	88	75	33	22.5	24.2	3.2	72
206V1	48	50	69	88	75	32	22.5	24.2	3.2	72
216M1	67	50	69	88	75	38	30.5	33	4.8	72
216N1	67	50	69	88	75	33	30.5	33	4.8	72
216V1	64	50	69	88	75	39	30.5	33	4.8	72

Switching programmes 6 and 8 pole



Types H216 / H220 / H226 / H233:

Mtg. form	A	B	B1	B2	C	C1	D1	G1	G2	H
206M1	67	72	84	96	83	38	22.5	24.2	3.2	70
206N1	67	72	84	96	83	33	22.5	24.2	3.2	70
216M1	67	72	84	96	83	38	30.5	33	4.8	70
216N1	67	72	84	96	83	33	30.5	33	4.8	70
216V1	64	72	84	96	83	39	30.5	33	4.8	70

Main Switches

- Base mounting switches with snap-on mounting
- for DIN rail
- 3 up to 8 pole
- 20 A up to 125 A
- IP30

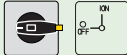

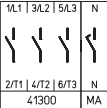
Switching programme	Rated data (IEC 60947)			Escutcheon dimension for 45 mm aperture in Panel/Distribution boards (H × W) (mm)	Padlockable handle V-handle grey/black  IP30	Order code number
	Operat. current I _e (A)	Operational power (at 380–440 V) (kW)				
41300 – 3 pole – without auxiliary contacts 	20	5.5	3.7	45 × 48		H216-41300-026V1
	20	5.5	3.7	45 × 60		H216-41300-126V1
	25	7.5	5.5	45 × 48		H220-41300-026V1
	25	7.5	5.5	45 × 60		H220-41300-126V1
	32	11	7.5	45 × 48		H226-41300-026V1
	32	11	7.5	45 × 60		H226-41300-126V1
	40	15	11	45 × 48		H233-41300-026V1
	40	15	11	45 × 52.5		B240-41300-026V1*
	40	15	11	45 × 60		H233-41300-126V1
	50	18.5	15	45 × 52.5		B250-41300-026V1
	63	22	18.5	45 × 52.5		B263-41300-026V1
	63	22	18.5	45 × 72		H406-41300-126V1*
	80	30	22	45 × 72		H408-41300-126V1
	100	37	30	45 × 72		H410-41300-126V1
125	45	37	45 × 72		H412-41300-126V1	
41400 – 4 pole – without auxiliary contacts – neutral contact – early make/late break 	20	5.5	3.7	45 × 48		H216-41400-026V1
	20	5.5	3.7	45 × 60		H216-41400-126V1
	25	7.5	5.5	45 × 48		H220-41400-026V1
	25	7.5	5.5	45 × 60		H220-41400-126V1
	32	11	7.5	45 × 48		H226-41400-026V1
	32	11	7.5	45 × 60		H226-41400-126V1
	40	15	11	45 × 48		H233-41400-026V1
	40	15	11	45 × 52.5		B240-41400-026V1*
	40	15	11	45 × 60		H233-41400-126V1
	50	18.5	15	45 × 52.5		B250-41400-026V1
	63	22	18.5	45 × 52.5		B263-41400-026V1
	63	22	18.5	45 × 72		H406-41400-126V1*
	80	30	22	45 × 72		H408-41400-126V1
	100	37	30	45 × 72		H410-41400-126V1
125	45	37	45 × 72		H412-41400-126V1	

* larger terminal capacity, see page 154

Further switching programmes from page 132.

Disconnect Switches

Main Switches **Base mounting** Snap-on mounting for DIN rail

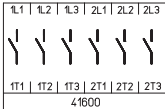
Switching programme	Rated data (IEC 60947)			Escutcheon dimension for 45 mm aperture in Panel/Distribution boards (H × W) (mm)	Padlockable handle V-handle grey/black IP30	Order code number
	Operat. current I _e	Operational power (at 380–440 V)				
	AC-21A (A)	AC-23A (kW)	AC-3 (kW)			
41600 – 6 pole – without auxiliary contacts 	20	5.5	3.7	45 × 76	H216-41600-026V1	
	25	7.5	5.5	45 × 76	H220-41600-026V1	
	32	11	7.5	45 × 76	H226-41600-026V1	
	40	15	11	45 × 76	H233-41600-026V1	
	40	15	11	45 × 105	B240-41600-026V1*	
	50	18.5	15	45 × 105	B250-41600-026V1	
	63	22	18.5	45 × 105	B263-41600-026V1	
	63	22	18.5	45 × 72	H406-41600-126V1*	
	80	30	22	45 × 72	H408-41600-126V1	
	100	37	30	45 × 72	H410-41600-126V1	
	125	45	37	45 × 72	H412-41600-126V1	

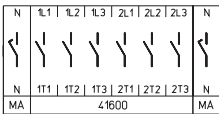
41800 – 8 pole – without auxiliary contacts – 2 neutral contacts early make/late break 	20	5.5	3.7	45 × 76	H216-41800-026V1	
	25	7.5	5.5	45 × 76	H220-41800-026V1	
	32	11	7.5	45 × 76	H226-41800-026V1	
	40	15	11	45 × 76	H233-41800-026V1	
	40	15	11	45 × 105	B240-41800-026V1*	
	50	18.5	15	45 × 105	B250-41800-026V1	
	63	22	18.5	45 × 105	B263-41800-026V1	
	63	22	18.5	45 × 72	H406-41800-126V1*	
	80	30	22	45 × 72	H408-41800-126V1	
	100	37	30	45 × 72	H410-41800-126V1	
	125	45	37	45 × 72	H412-41800-126V1	

* larger terminal capacity, see page 154
Further switching programmes from page 132.

Dimensions in mm:

Setup of order code number		
Type	Switching progr.	Mtg. form
H216	41300	026V1
Order code no.	H216-41300-026V1	

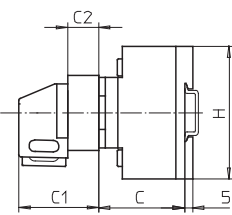
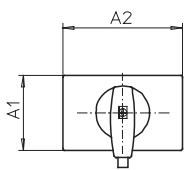
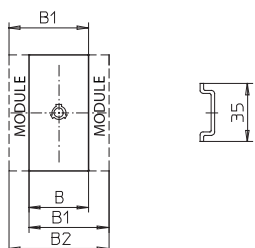
Switching programmes 3 and 4 pole

Types H216 / H220 / H226 / H233:

Mtg. form	A1	A2	B	B1	B2	C	C1	C2	H
026V1	45	48	36	48	60	38	45	18.5	70
126V1	45	60	36	48	60	38	45	18.5	70

Types B240 / B250 / B263:

Mtg. form	A1	A2	B	B1	B2	C	C1	C2	H
026V1	45	52.5	50	69	88	38	45	18.5	72

Types H406 / H408 / H410 / H412:

Mtg. form	A1	A2	B	B1	B2	C	C1	C2	H
126V1	45	72	70	89	108	55	48	16	80

Switching programmes 6 and 8 pole

Types H216 / H220 / H226 / H233:

Mtg. form	A1	A2	B	B1	B2	C	C1	C2	H
026V1	45	76	72	84	96	40	51.5	25.5	70

Types B240 / B250 / B263:

Mtg. form	A1	A2	B	B1	B2	C	C1	C2	H
026V1	45	105	100	119	138	40	51.5	25.5	72

Types H406 / H408 / H410 / H412:

Mtg. form	A1	A2	B	B1	B2	C	C1	C2	H
126V1	45	72	140	159	178	67	48	16	80

Main Switches

- Base mounting switches with snap-on mounting
- Door interlock
- 3 up to 8 pole
- 20 A up to 125 A
- **IP66**
- with modular or metal shaft extension
- single or four hole front mounting



Base mounting switches with snap-on mounting and door interlock are offered with two different extensions:

1. Switches with **modular shaft extensions** can be extended with additional modules (modular shaft extensions see picture) which can be fixed to achieve different required mounting depths – dimension C. The modules therefore are detailed on page 145.

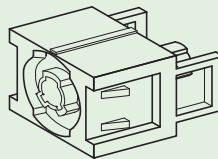
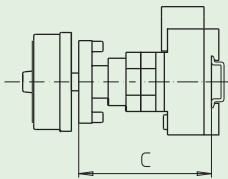

AVC2/AVC4
Modular shaft extension

2. For switches with **metal shaft extension** the metal shaft is not included in the scope of delivery and has to be ordered separately. Data for mounting dimension C and for the different types of metal shafts can be found on page 146.

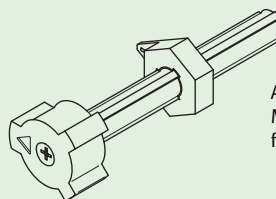
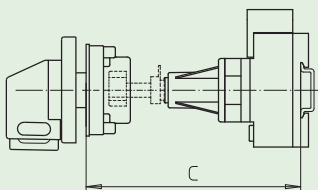

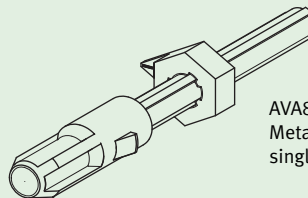
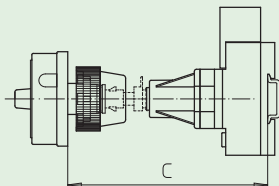

AVB8
Metal shaft extension for
four hole front mounting



AVA8
Metal shaft extension for
single hole front mounting

Disconnect Switches

Main Switches **Base mounting** Snap-on mounting with door interlock

Switching programme	Rated data (IEC 60947)			Mounting dimension (front) (mm)	Padlock device N-handle black	Padlock device M-handle black	Padlockable handle V-handle silver/black
	Operat. current I_e	Operational power (at 380–440 V)					
	AC-21A (A)	AC-23A (kW)	AC-3 (kW)		IP66	IP66	IP66
					Order code number	Order code number	Order code number

41300
– 3 pole
– without auxiliary contacts



Modular shaft extension:

➔ Modular shaft extensions see page 145!

20	25	32	40	50	63	80	100	125	36 × 36	48 × 48	36 × 36	48 × 48	36 × 36	48 × 48	36 × 36	48 × 48	36 × 36	48 × 48
20	5.5	3.7	36 × 36	H216-41300-234N1	H216-41300-234M1	H216-41300-234V1												
20	5.5	3.7	48 × 48	H216-41300-238N1	H216-41300-238M1	H216-41300-238V1												
25	7.5	5.5	36 × 36	H220-41300-234N1	H220-41300-234M1	H220-41300-234V1												
25	7.5	5.5	48 × 48	H220-41300-238N1	H220-41300-238M1	H220-41300-238V1												
32	11	7.5	36 × 36	H226-41300-234N1	H226-41300-234M1	H226-41300-234V1												
32	11	7.5	48 × 48	H226-41300-238N1	H226-41300-238M1	H226-41300-238V1												
40	15	11	36 × 36	H233-41300-234N1	H233-41300-234M1	H233-41300-234V1												
40	15	11	36 × 36	B240-41300-234N1*	B240-41300-234M1*	B240-41300-234V1*												
40	15	11	48 × 48	H233-41300-238N1	H233-41300-238M1	H233-41300-238V1												
40	15	11	48 × 48	B240-41300-238N1*	B240-41300-238M1*	B240-41300-238V1*												
50	18.5	15	36 × 36	B250-41300-234N1	B250-41300-234M1	B250-41300-234V1												
50	18.5	15	48 × 48	B250-41300-238N1	B250-41300-238M1	B250-41300-238V1												
63	22	18.5	36 × 36	B263-41300-234N1	B263-41300-234M1	B263-41300-234V1												
63	22	18.5	48 × 48	B263-41300-238N1	B263-41300-238M1	B263-41300-238V1												
63	22	18.5	48 × 48	H406-41300-234N1*	H406-41300-234M1*	H406-41300-234V1*												
80	30	22	48 × 48	H408-41300-234N1	H408-41300-234M1	H408-41300-234V1												
100	37	30	48 × 48	H410-41300-234N1	H410-41300-234M1	H410-41300-234V1												
125	45	37	48 × 48	H412-41300-234N1	H412-41300-234M1	H412-41300-234V1												

Metal shaft extension:

➔ Metal shaft is not included. Please order separately, see page 146!

20	25	32	40	50	63	80	100	125	36 × 36	48 × 48	∅ 22.5	36 × 36	48 × 48	∅ 22.5	36 × 36	48 × 48	∅ 22.5	36 × 36	48 × 48	∅ 22.5
20	5.5	3.7	36 × 36	H216-41300-483N1	H216-41300-483M1	H216-41300-483V1														
20	5.5	3.7	48 × 48	H216-41300-484N1	H216-41300-484M1	H216-41300-484V1														
20	5.5	3.7	∅ 22.5	H216-41300-281N1	H216-41300-281M1	H216-41300-281V1														
25	7.5	5.5	36 × 36	H220-41300-483N1	H220-41300-483M1	H220-41300-483V1														
25	7.5	5.5	48 × 48	H220-41300-484N1	H220-41300-484M1	H220-41300-484V1														
25	7.5	5.5	∅ 22.5	H220-41300-281N1	H220-41300-281M1	H220-41300-281V1														
32	11	7.5	36 × 36	H226-41300-483N1	H226-41300-483M1	H226-41300-483V1														
32	11	7.5	48 × 48	H226-41300-484N1	H226-41300-484M1	H226-41300-484V1														
32	11	7.5	∅ 22.5	H226-41300-281N1	H226-41300-281M1	H226-41300-281V1														
40	15	11	36 × 36	H233-41300-483N1	H233-41300-483M1	H233-41300-483V1														
40	15	11	36 × 36	B240-41300-483N1*	B240-41300-483M1*	B240-41300-483V1*														
40	15	11	48 × 48	H233-41300-484N1	H233-41300-484M1	H233-41300-484V1														
40	15	11	48 × 48	B240-41300-484N1*	B240-41300-484M1*	B240-41300-484V1*														
40	15	11	∅ 22.5	H233-41300-281N1	H233-41300-281M1	H233-41300-281V1														
40	15	11	∅ 22.5	B240-41300-281N1*	B240-41300-281M1*	B240-41300-281V1*														
50	18.5	15	36 × 36	B250-41300-483N1	B250-41300-483M1	B250-41300-483V1														
50	18.5	15	48 × 48	B250-41300-484N1	B250-41300-484M1	B250-41300-484V1														
50	18.5	15	∅ 22.5	B250-41300-281N1	B250-41300-281M1	B250-41300-281V1														
63	22	18.5	36 × 36	B263-41300-483N1	B263-41300-483M1	B263-41300-483V1														
63	22	18.5	48 × 48	B263-41300-484N1	B263-41300-484M1	B263-41300-484V1														
63	22	18.5	48 × 48	H406-41300-483N1*	H406-41300-483M1*	H406-41300-483V1*														
63	22	18.5	∅ 22.5	B263-41300-281N1	B263-41300-281M1	B263-41300-281V1														
63	22	18.5	∅ 22.5	H406-41300-281N1*	H406-41300-281M1*	H406-41300-281V1*														
80	30	22	48 × 48	H408-41300-483N1	H408-41300-483M1	H408-41300-483V1														
80	30	22	∅ 22.5	H408-41300-281N1	H408-41300-281M1	H408-41300-281V1														
100	37	30	48 × 48	H410-41300-483N1	H410-41300-483M1	H410-41300-483V1														
100	37	30	∅ 22.5	H410-41300-281N1	H410-41300-281M1	H410-41300-281V1														
125	45	37	48 × 48	H412-41300-483N1	H412-41300-483M1	H412-41300-483V1														
125	45	37	∅ 22.5	H412-41300-281N1	H412-41300-281M1	H412-41300-281V1														

* larger terminal capacity, see page 154

Further switching programmes from page 132.

Switching programme	Rated data (IEC 60947)			Mounting dimension (front) (mm)	Padlock device N-handle black	Padlock device M-handle black	Padlockable handle V-handle silver/black
	Operat. current I _e	Operational power (at 380–440 V)			IP66	IP66	IP66
	AC-21A (A)	AC-23A (kW)	AC-3 (kW)		Order code number	Order code number	Order code number

41400

- 4 pole
- without auxiliary contacts
- neutral contact early make/late break

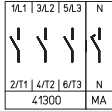

Modular shaft extension:

→ Modular shaft extensions see page 145!

20	25	32	40	50	63	80	100	125	36 × 36	48 × 48	36 × 36	48 × 48	36 × 36	48 × 48	36 × 36	48 × 48	36 × 36	48 × 48
20	25	32	40	50	63	80	100	125	36 × 36	48 × 48	H216-41400-234N1	H216-41400-238N1	H216-41400-234M1	H216-41400-238M1	H216-41400-234V1	H216-41400-238V1		
20	25	32	40	50	63	80	100	125	36 × 36	48 × 48	H220-41400-234N1	H220-41400-238N1	H220-41400-234M1	H220-41400-238M1	H220-41400-234V1	H220-41400-238V1		
20	25	32	40	50	63	80	100	125	36 × 36	48 × 48	H226-41400-234N1	H226-41400-238N1	H226-41400-234M1	H226-41400-238M1	H226-41400-234V1	H226-41400-238V1		
20	25	32	40	50	63	80	100	125	36 × 36	48 × 48	H233-41400-234N1	H233-41400-238N1	H233-41400-234M1	H233-41400-238M1	H233-41400-234V1	H233-41400-238V1		
20	25	32	40	50	63	80	100	125	36 × 36	48 × 48	B240-41400-234N1*	B240-41400-238N1*	B240-41400-234M1*	B240-41400-238M1*	B240-41400-234V1*	B240-41400-238V1*		
20	25	32	40	50	63	80	100	125	36 × 36	48 × 48	H250-41400-234N1	H250-41400-238N1	H250-41400-234M1	H250-41400-238M1	H250-41400-234V1	H250-41400-238V1		
20	25	32	40	50	63	80	100	125	36 × 36	48 × 48	B263-41400-234N1	B263-41400-238N1	B263-41400-234M1	B263-41400-238M1	B263-41400-234V1	B263-41400-238V1		
20	25	32	40	50	63	80	100	125	36 × 36	48 × 48	H406-41400-234N1*	H406-41400-238N1*	H406-41400-234M1*	H406-41400-238M1*	H406-41400-234V1*	H406-41400-238V1*		
20	25	32	40	50	63	80	100	125	36 × 36	48 × 48	H408-41400-234N1	H408-41400-238N1	H408-41400-234M1	H408-41400-238M1	H408-41400-234V1	H408-41400-238V1		
20	25	32	40	50	63	80	100	125	36 × 36	48 × 48	H410-41400-234N1	H410-41400-238N1	H410-41400-234M1	H410-41400-238M1	H410-41400-234V1	H410-41400-238V1		
20	25	32	40	50	63	80	100	125	36 × 36	48 × 48	H412-41400-234N1	H412-41400-238N1	H412-41400-234M1	H412-41400-238M1	H412-41400-234V1	H412-41400-238V1		

Metal shaft extension:

→ Metal shaft is not included. Please order separately, see page 146!



20	25	32	40	50	63	80	100	125	36 × 36	48 × 48	Ø 22.5	36 × 36	48 × 48	Ø 22.5	36 × 36	48 × 48	Ø 22.5	36 × 36	48 × 48	Ø 22.5
20	25	32	40	50	63	80	100	125	36 × 36	48 × 48	Ø 22.5	H216-41400-483N1	H216-41400-484N1	H216-41400-483M1	H216-41400-484M1	H216-41400-483V1	H216-41400-484V1			
20	25	32	40	50	63	80	100	125	36 × 36	48 × 48	Ø 22.5	H220-41400-483N1	H220-41400-484N1	H220-41400-483M1	H220-41400-484M1	H220-41400-483V1	H220-41400-484V1			
20	25	32	40	50	63	80	100	125	36 × 36	48 × 48	Ø 22.5	H226-41400-483N1	H226-41400-484N1	H226-41400-483M1	H226-41400-484M1	H226-41400-483V1	H226-41400-484V1			
20	25	32	40	50	63	80	100	125	36 × 36	48 × 48	Ø 22.5	H233-41400-483N1	H233-41400-484N1	H233-41400-483M1	H233-41400-484M1	H233-41400-483V1	H233-41400-484V1			
20	25	32	40	50	63	80	100	125	36 × 36	48 × 48	Ø 22.5	B240-41400-483N1*	B240-41400-484N1*	B240-41400-483M1*	B240-41400-484M1*	B240-41400-483V1*	B240-41400-484V1*			
20	25	32	40	50	63	80	100	125	36 × 36	48 × 48	Ø 22.5	H250-41400-483N1	H250-41400-484N1	H250-41400-483M1	H250-41400-484M1	H250-41400-483V1	H250-41400-484V1			
20	25	32	40	50	63	80	100	125	36 × 36	48 × 48	Ø 22.5	B263-41400-483N1	B263-41400-484N1	B263-41400-483M1	B263-41400-484M1	B263-41400-483V1	B263-41400-484V1			
20	25	32	40	50	63	80	100	125	36 × 36	48 × 48	Ø 22.5	H406-41400-483N1*	H406-41400-484N1*	H406-41400-483M1*	H406-41400-484M1*	H406-41400-483V1*	H406-41400-484V1*			
20	25	32	40	50	63	80	100	125	36 × 36	48 × 48	Ø 22.5	B263-41400-281N1	B263-41400-281N1	B263-41400-281M1	B263-41400-281M1	B263-41400-281V1	B263-41400-281V1			
20	25	32	40	50	63	80	100	125	36 × 36	48 × 48	Ø 22.5	H406-41400-281N1*	H406-41400-281N1*	H406-41400-281M1*	H406-41400-281M1*	H406-41400-281V1*	H406-41400-281V1*			
20	25	32	40	50	63	80	100	125	36 × 36	48 × 48	Ø 22.5	H408-41400-483N1	H408-41400-484N1	H408-41400-483M1	H408-41400-484M1	H408-41400-483V1	H408-41400-484V1			
20	25	32	40	50	63	80	100	125	36 × 36	48 × 48	Ø 22.5	H408-41400-281N1	H408-41400-281N1	H408-41400-281M1	H408-41400-281M1	H408-41400-281V1	H408-41400-281V1			
20	25	32	40	50	63	80	100	125	36 × 36	48 × 48	Ø 22.5	H410-41400-483N1	H410-41400-484N1	H410-41400-483M1	H410-41400-484M1	H410-41400-483V1	H410-41400-484V1			
20	25	32	40	50	63	80	100	125	36 × 36	48 × 48	Ø 22.5	H410-41400-281N1	H410-41400-281N1	H410-41400-281M1	H410-41400-281M1	H410-41400-281V1	H410-41400-281V1			
20	25	32	40	50	63	80	100	125	36 × 36	48 × 48	Ø 22.5	H412-41400-483N1	H412-41400-484N1	H412-41400-483M1	H412-41400-484M1	H412-41400-483V1	H412-41400-484V1			
20	25	32	40	50	63	80	100	125	36 × 36	48 × 48	Ø 22.5	H412-41400-281N1	H412-41400-281N1	H412-41400-281M1	H412-41400-281M1	H412-41400-281V1	H412-41400-281V1			

* larger terminal capacity, see page 154

Further switching programmes from page 132.

Disconnect Switches

Main Switches **Base mounting** Snap-on mounting with door interlock

Switching programme	Rated data (IEC 60947)			Mounting dimension (front) (mm)	Padlock device N-handle black	Padlock device M-handle black	Padlockable handle V-handle silver/black
	Operat. current I_e	Operational power (at 380–440 V)			 OFF ON IP66	 OFF ON IP66	 OFF ON IP66
	AC-21A (A)	AC-23A (kW)	AC-3 (kW)		Order code number	Order code number	Order code number

41600
– 6 pole
– without auxiliary contacts

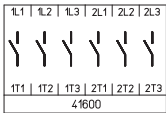

Modular shaft extension:

➔ Modular shaft extensions see page 145!

20	5.5	3.7	36 x 36	H216-41600-234N1	H216-41600-234M1	–
20	5.5	3.7	48 x 48	H216-41600-238N1	H216-41600-238M1	H216-41600-238V1
25	7.5	5.5	36 x 36	H220-41600-234N1	H220-41600-234M1	–
25	7.5	5.5	48 x 48	H220-41600-238N1	H220-41600-238M1	H220-41600-238V1
32	11	7.5	36 x 36	H226-41600-234N1	H226-41600-234M1	–
32	11	7.5	48 x 48	H226-41600-238N1	H226-41600-238M1	H226-41600-238V1
40	15	11	36 x 36	H233-41600-234N1	H233-41600-234M1	–
40	15	11	36 x 36	B240-41600-234N1*	B240-41600-234M1*	–
40	15	11	48 x 48	H233-41600-238N1	H233-41600-238M1	H233-41600-238V1
40	15	11	48 x 48	B240-41600-238N1*	B240-41600-238M1*	B240-41600-238V1*
50	18.5	15	36 x 36	B250-41600-234N1	B250-41600-234M1	–
50	18.5	15	48 x 48	B250-41600-238N1	B250-41600-238M1	B250-41600-238V1
63	22	18.5	36 x 36	B263-41600-234N1	B263-41600-234M1	–
63	22	18.5	48 x 48	B263-41600-238N1	B263-41600-238M1	B263-41600-238V1
63	22	18.5	48 x 48	H406-41600-234N1*	H406-41600-234M1*	H406-41600-234V1*
80	30	22	48 x 48	H408-41600-234N1	H408-41600-234M1	H408-41600-234V1
100	37	30	48 x 48	H410-41600-234N1	H410-41600-234M1	H410-41600-234V1
125	45	37	48 x 48	H412-41600-234N1	H412-41600-234M1	H412-41600-234V1



Metal shaft extension:

➔ Metal shaft is not included. Please order separately, see page 146!

20	5.5	3.7	36 x 36	H216-41600-483N1	H216-41600-483M1	–
20	5.5	3.7	48 x 48	H216-41600-484N1	H216-41600-484M1	H216-41600-484V1
20	5.5	3.7	∅ 22.5	H216-41600-281N1	H216-41600-281M1	–
25	7.5	5.5	36 x 36	H220-41600-483N1	H220-41600-483M1	–
25	7.5	5.5	48 x 48	H220-41600-484N1	H220-41600-484M1	H220-41600-484V1
25	7.5	5.5	∅ 22.5	H220-41600-281N1	H220-41600-281M1	–
32	11	7.5	36 x 36	H226-41600-483N1	H226-41600-483M1	–
32	11	7.5	48 x 48	H226-41600-484N1	H226-41600-484M1	H226-41600-484V1
32	11	7.5	∅ 22.5	H226-41600-281N1	H226-41600-281M1	–
40	15	11	36 x 36	H233-41600-483N1	H233-41600-483M1	–
40	15	11	36 x 36	B240-41600-483N1*	B240-41600-483M1*	–
40	15	11	48 x 48	H233-41600-484N1	H233-41600-484M1	H233-41600-484V1
40	15	11	48 x 48	B240-41600-484N1*	B240-41600-484M1*	B240-41600-484V1*
40	15	11	∅ 22.5	H233-41600-281N1	H233-41600-281M1	–
40	15	11	∅ 22.5	B240-41600-281N1*	B240-41600-281M1*	–
50	18.5	15	36 x 36	B250-41600-483N1	B250-41600-483M1	–
50	18.5	15	48 x 48	B250-41600-484N1	B250-41600-484M1	B250-41600-484V1
50	18.5	15	∅ 22.5	B250-41600-281N1	B250-41600-281M1	–
63	22	18.5	36 x 36	B263-41600-483N1	B263-41600-483M1	–
63	22	18.5	48 x 48	B263-41600-484N1	B263-41600-484M1	B263-41600-484V1
63	22	18.5	48 x 48	H406-41600-483N1*	H406-41600-483M1*	H406-41600-483V1*
63	22	18.5	∅ 22.5	B263-41600-281N1	B263-41600-281M1	–
63	22	18.5	∅ 22.5	H406-41600-281N1*	H406-41600-281M1*	H406-41600-281V1
80	30	22	48 x 48	H408-41600-483N1	H408-41600-483M1	H408-41600-483V1
80	30	22	∅ 22.5	H408-41600-281N1	H408-41600-281M1	H408-41600-281V1
100	37	30	48 x 48	H410-41600-483N1	H410-41600-483M1	H410-41600-483V1
100	37	30	∅ 22.5	H410-41600-281N1	H410-41600-281M1	H410-41600-281V1
125	45	37	48 x 48	H412-41600-483N1	H412-41600-483M1	H412-41600-483V1
125	45	37	∅ 22.5	H412-41600-281N1	H412-41600-281M1	H412-41600-281V1

* larger terminal capacity, see page 154

Further switching programmes from page 132.

Switching programme	Rated data (IEC 60947)			Mounting dimension (front) (mm)	Padlock device N-handle black	Padlock device M-handle black	Padlockable handle V-handle silver/black
	Operat. current I _e	Operational power (at 380–440 V)					
	AC-21A (A)	AC-23A (kW)	AC-3 (kW)		IP66	IP66	IP66
					Order code number	Order code number	Order code number

- 41800**
 – 8 pole
 – without auxiliary contacts
 – 2 neutral contacts
 – early make/late break

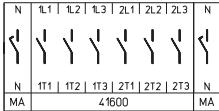

Modular shaft extension:

➔ Modular shaft extensions see page 145!

20	5.5	3.7	36 x 36	H216-41800-234N1	H216-41800-234M1	–
20	5.5	3.7	48 x 48	H216-41800-238N1	H216-41800-238M1	H216-41800-238V1
25	7.5	5.5	36 x 36	H220-41800-234N1	H220-41800-234M1	–
25	7.5	5.5	48 x 48	H220-41800-238N1	H220-41800-238M1	H220-41800-238V1
32	11	7.5	36 x 36	H226-41800-234N1	H226-41800-234M1	–
32	11	7.5	48 x 48	H226-41800-238N1	H226-41800-238M1	H226-41800-238V1
40	15	11	36 x 36	H233-41800-234N1	H233-41800-234M1	–
40	15	11	36 x 36	B240-41800-234N1*	B240-41800-234M1*	–
40	15	11	48 x 48	H233-41800-238N1	H233-41800-238M1	H233-41800-238V1
40	15	11	48 x 48	B240-41800-238N1*	B240-41800-238M1*	B240-41800-238V1*
50	18.5	15	36 x 36	B250-41800-234N1	B250-41800-234M1	–
50	18.5	15	48 x 48	B250-41800-238N1	B250-41800-238M1	B250-41800-238V1
63	22	18.5	36 x 36	B263-41800-234N1	B263-41800-234M1	–
63	22	18.5	48 x 48	B263-41800-238N1	B263-41800-238M1	B263-41800-238V1
63	22	18.5	48 x 48	H406-41800-234N1*	H406-41800-234M1*	H406-41800-234V1*
80	30	22	48 x 48	H408-41800-234N1	H408-41800-234M1	H408-41800-234V1
100	37	30	48 x 48	H410-41800-234N1	H410-41800-234M1	H410-41800-234V1
125	45	37	48 x 48	H412-41800-234N1	H412-41800-234M1	H412-41800-234V1

Metal shaft extension:

➔ Metal shaft is not included. Please order separately, see page 146!

20	5.5	3.7	36 x 36	H216-41800-483N1	H216-41800-483M1	–
20	5.5	3.7	48 x 48	H216-41800-484N1	H216-41800-484M1	H216-41800-484V1
20	5.5	3.7	Ø 22.5	H216-41800-281N1	H216-41800-281M1	–
25	7.5	5.5	36 x 36	H220-41800-483N1	H220-41800-483M1	–
25	7.5	5.5	48 x 48	H220-41800-484N1	H220-41800-484M1	H220-41800-484V1
25	7.5	5.5	Ø 22.5	H220-41800-281N1	H220-41800-281M1	–
32	11	7.5	36 x 36	H226-41800-483N1	H226-41800-483M1	–
32	11	7.5	48 x 48	H226-41800-484N1	H226-41800-484M1	H226-41800-484V1
32	11	7.5	Ø 22.5	H226-41800-281N1	H226-41800-281M1	–
40	15	11	36 x 36	H233-41800-483N1	H233-41800-483M1	–
40	15	11	36 x 36	B240-41800-483N1*	B240-41800-483M1*	–
40	15	11	48 x 48	H233-41800-484N1	H233-41800-484M1	H233-41800-484V1
40	15	11	48 x 48	B240-41800-484N1*	B240-41800-484M1*	B240-41800-484V1*
40	15	11	Ø 22.5	H233-41800-281N1	H233-41800-281M1	–
40	15	11	Ø 22.5	B240-41800-281N1*	B240-41800-281M1*	–
50	18.5	15	36 x 36	B250-41800-483N1	B250-41800-483M1	–
50	18.5	15	48 x 48	B250-41800-484N1	B250-41800-484M1	B250-41800-484V1
50	18.5	15	Ø 22.5	B250-41800-281N1	B250-41800-281M1	–
63	22	18.5	36 x 36	B263-41800-483N1	B263-41800-483M1	–
63	22	18.5	48 x 48	B263-41800-484N1	B263-41800-484M1	B263-41800-484V1
63	22	18.5	48 x 48	H406-41800-483N1*	H406-41800-483M1*	H406-41800-483V1*
63	22	18.5	Ø 22.5	B263-41800-281N1	B263-41800-281M1	–
63	22	18.5	Ø 22.5	H406-41800-281N1*	H406-41800-281M1*	H406-41800-281V1
80	30	22	48 x 48	H408-41800-483N1	H408-41800-483M1	H408-41800-483V1
80	30	22	Ø 22.5	H408-41800-281N1	H408-41800-281M1	H408-41800-281V1
100	37	30	48 x 48	H410-41800-483N1	H410-41800-483M1	H410-41800-483V1
100	37	30	Ø 22.5	H410-41800-281N1	H410-41800-281M1	H410-41800-281V1
125	45	37	48 x 48	H412-41800-483N1	H412-41800-483M1	H412-41800-483V1
125	45	37	Ø 22.5	H412-41800-281N1	H412-41800-281M1	H412-41800-281V1

* larger terminal capacity, see page 154

Further switching programmes from page 132.

Disconnect Switches

Main Switches **Base mounting** Snap-on mounting with door interlock

Dimensions in mm:

Door interlock with **modular shaft extension**: Four hole front mounting

Setup of order code number		
Type	Switching progr.	Mtg. form
H233	41400	234N1
Order code no. H233-41400-234N1		

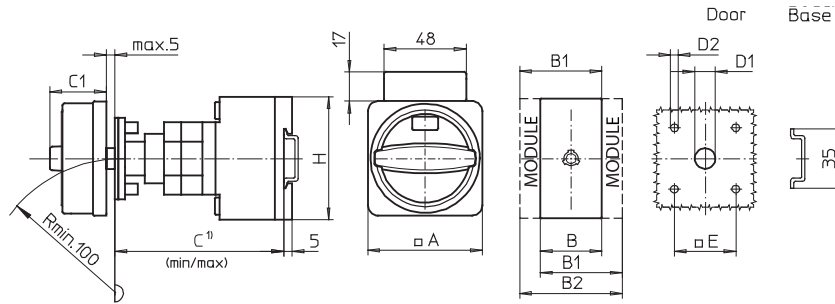

¹⁾ Internal depth: inside of door to top of DIN rail, dimensions with shaft extension see page 145.

Switching programmes 3 and 4 pole

Types H216 / H220 / H226 / H233:

Mtg. form	A	B	B1	B2	C _{min}	C _{max}	C1	D1	D2	E	H
234M1	67	36	48	60	92	107	38	15	4.5	36	70
234N1	67	36	48	60	92	107	33	15	4.5	36	70
234V1	48	36	48	60	92	107	32	12	4.5	36	70
238M1	67	36	48	60	92	107	38	15	5	48	70
238N1	67	36	48	60	92	107	33	15	5	48	70
238V1	64	36	48	60	92	107	39	15	5	48	70

Switching programmes 6 and 8 pole

Types H216 / H220 / H226 / H233:

Mtg. form	A	B	B1	B2	C _{min}	C _{max}	C1	D1	D2	E	H
234M1	67	72	84	96	100	115	38	15	4.5	36	70
234N1	67	72	84	96	100	115	33	15	4.5	36	70
238M1	67	72	84	96	100	115	38	15	5	48	70
238N1	67	72	84	96	100	115	33	15	5	48	70
238V1	64	72	84	96	100	115	39	15	5	48	70

Types B240 / B250 / B263:

Mtg. form	A	B	B1	B2	C _{min}	C _{max}	C1	D1	D2	E	H
234M1	67	50	69	88	92	107	38	15	4.5	36	72
234N1	67	50	69	88	92	107	33	15	4.5	36	72
234V1	48	50	69	88	92	107	32	12	4.5	36	72
238M1	67	50	69	88	92	107	38	15	5	48	72
238N1	67	50	69	88	92	107	33	15	5	48	72
238V1	64	50	69	88	92	107	39	15	5	48	72

Types B240 / B250 / B263:

Mtg. form	A	B	B1	B2	C _{min}	C _{max}	C1	D1	D2	E	H
234M1	67	100	119	138	104	119	38	15	4.5	36	72
234N1	67	100	119	138	104	119	33	15	4.5	36	72
238M1	67	100	119	138	104	119	38	15	5	48	72
238N1	67	100	119	138	104	119	33	15	5	48	72
238V1	64	100	119	138	104	119	39	15	5	48	72

Types H406 / H408 / H410 / H412:

Mtg. form	A	B	B1	B2	C _{min}	C _{max}	C1	D1	D2	E	H
234M1	88	70	89	108	102	117	50	15	5	48	80
234N1	88	70	89	108	102	117	45	15	5	48	80
234V1	64	70	89	108	102	117	40	15	5	48	80

Types H406 / H408 / H410 / H412:

Mtg. form	A	B	B1	B2	C _{min}	C _{max}	C1	D1	D2	E	H
234M1	88	140	159	178	115	130	50	15	5	48	80
234N1	88	140	159	178	115	130	45	15	5	48	80
234V1	64	140	159	178	115	130	40	15	5	48	80

Dimensions in mm:

Door interlock with **metal shaft extension**: Four hole front mounting

Setup of order code number		
Type	Switching progr.	Mtg. form
H406	41800	483N1
Order code no. H406-41800-483N1		

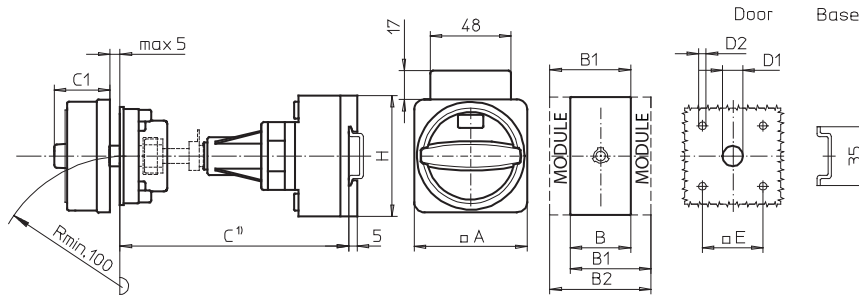

¹⁾ Internal depth: inside of door to top of DIN rail, dimensions see page 146.

Switching programmes 3 and 4 pole

Types H216 / H220 / H226 / H233:

Mtg. form	A	B	B1	B2	C1	D1	D2	E	H
483M1	67	36	48	60	38	15	4.5	36	70
483N1	67	36	48	60	33	15	4.5	36	70
483V1	48	36	48	60	32	15	4.5	36	70
484M1	67	36	48	60	38	15	5	48	70
484N1	67	36	48	60	33	15	5	48	70
484V1	64	36	48	60	39	15	5	48	70

Types B240 / B250 / B263:

Mtg. form	A	B	B1	B2	C1	D1	D2	E	H
483M1	67	50	69	88	38	15	4.5	36	72
483N1	67	50	69	88	33	15	4.5	36	72
483V1	48	50	69	88	32	15	4.5	36	72
484M1	67	50	69	88	38	15	5	48	72
484N1	67	50	69	88	33	15	5	48	72
484V1	64	50	69	88	39	15	5	48	72

Types H406 / H408 / H410 / H412:

Mtg. form	A	B	B1	B2	C1	D1	D2	E	H
483M1	88	70	89	108	50	15	5	48	80
483N1	88	70	89	108	45	15	5	48	80
483V1	64	70	89	108	40	15	5	48	80

Switching programmes 6 and 8 pole

Types H216 / H220 / H226 / H233:

Mtg. form	A	B	B1	B2	C1	D1	D2	E	H
483M1	67	72	84	96	38	15	4.5	36	70
483N1	67	72	84	96	33	15	4.5	36	70
484M1	67	72	84	96	38	15	5	48	70
484N1	67	72	84	96	33	15	5	48	70
484V1	64	72	84	96	39	15	5	48	70

Types B240 / B250 / B263:

Mtg. form	A	B	B1	B2	C1	D1	D2	E	H
483M1	67	100	119	138	38	15	4.5	36	72
483N1	67	100	119	138	33	15	4.5	36	72
484M1	67	100	119	138	38	15	5	48	72
484N1	67	100	119	138	33	15	5	48	72
484V1	64	100	119	138	39	15	5	48	72

Types H406 / H408 / H410 / H412:

Mtg. form	A	B	B1	B2	C1	D1	D2	E	H
483M1	88	140	159	178	50	15	5	48	80
483N1	88	140	159	178	45	15	5	48	80
483V1	64	140	159	178	40	15	5	48	80

Disconnect Switches

Main Switches **Base mounting** Snap-on mounting with door interlock

Dimensions in mm:

Door interlock with **metal shaft extension**: Single hole front mounting

Setup of order code number		
Type	Switching progr.	Mtg. form
H233	41400	281N1
Order code no. H233-41400-281N1		

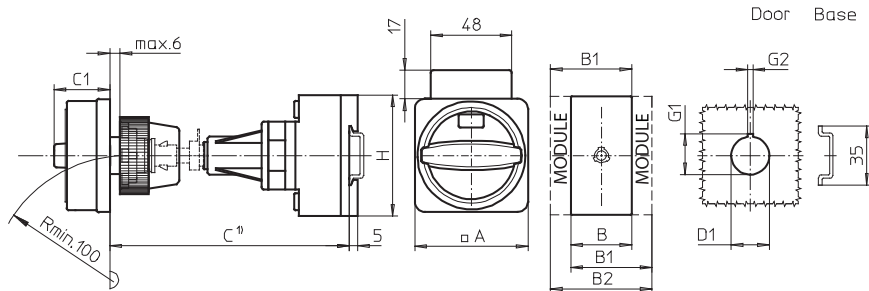

¹⁾ Internal depth: outside of door to top of DIN rail, dimensions see page 146.

Switching programmes 3 and 4 pole

Types H216 / H220 / H226 / H233:

Mtg. form	A	B	B1	B2	C1	D1	G1	G2	H
281M1	67	36	48	60	38	22.5	24.2	3.2	70
281N1	67	36	48	60	33	22.5	24.2	3.2	70
281V1	48	36	48	60	32	22.5	24.2	3.2	70

Types B240 / B250 / B263:

Mtg. form	A	B	B1	B2	C1	D1	G1	G2	H
281M1	67	50	69	88	38	22.5	24.2	3.2	72
281N1	67	50	69	88	33	22.5	24.2	3.2	72
281V1	48	50	69	88	32	22.5	24.2	3.2	72

Types H406 / H408 / H410 / H412:

Mtg. form	A	B	B1	B2	C1	D1	G1	G2	H
281M1	67	70	89	108	38	22.5	24.2	3.2	80
281N1	67	70	89	108	33	22.5	24.2	3.2	80
281V1	64	70	89	108	39	22.5	24.2	3.2	80

Switching programmes 6 and 8 pole

Types H216 / H220 / H226 / H233:

Mtg. form	A	B	B1	B2	C1	D1	G1	G2	H
281M1	67	72	84	96	38	22.5	24.2	3.2	70
281N1	67	72	84	96	33	22.5	24.2	3.2	70

Types B240 / B250 / B263:

Mtg. form	A	B	B1	B2	C1	D1	G1	G2	H
281M1	67	100	119	138	38	22.5	24.2	3.2	72
281N1	67	100	119	138	33	22.5	24.2	3.2	72



Types H406 / H408 / H410 / H412:

Mtg. form	A	B	B1	B2	C1	D1	G1	G2	H
281M1	67	140	159	178	38	22.5	24.2	3.2	80
281N1	67	140	159	178	33	22.5	24.2	3.2	80
281V1	64	140	159	178	39	22.5	24.2	3.2	80

Main Switches

- Base mounting switches with four hole mounting
- Door interlock
- 3 up to 8 pole
- 160 A up to 315 A
- IP55



Switching programme	Rated data (IEC 60947)			Mounting dimension (base/front) (mm)	Padlock device N-handle black	Padlock device M-handle black	Padlock device H-handle silver/black
	Operat. current I _e	Operational power (at 380–440 V)			 IP55	 IP55	 IP55
	AC-21A (A)	AC-23A (kW)	AC-3 (kW)		Order code number	Order code number	Order code number
41300 – 3 pole – without auxiliary contacts	160	75	45	68 × 68 / 68 × 68	K616-41300-034N1	K616-41300-034M1	K616-41300-034H1
	315	132	55	104 × 104 / 104 × 104	–	–	K830-41300-034H1



41400 – 4 pole – without auxiliary contacts – neutral contact early make/late break	160	75	45	68 × 68 / 68 × 68	K616-41400-034N1	K616-41400-034M1	K616-41400-034H1
	315	132	55	104 × 104 / 104 × 104	–	–	K830-41400-034H1

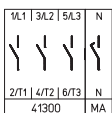

41600 – 6 pole – without auxiliary contacts	160	75	45	68 × 68 / 68 × 68	K616-41600-034N1	K616-41600-034M1	K616-41600-034H1
	315	132	55	104 × 104 / 104 × 104	–	–	K830-41600-034H1

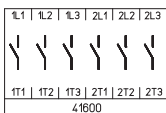

41800 – 8 pole – without auxiliary contacts – 2 neutral contacts early make/late break	160	75	45	68 × 68 / 68 × 68	K616-41800-034N1	K616-41800-034M1	K616-41800-034H1
	315	132	55	104 × 104 / 104 × 104	–	–	K830-41800-034H1

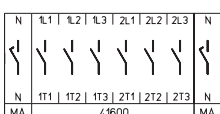

Disconnect Switches

Main Switches Base mounting Four hole mounting with door interlock

Dimensions in mm:

Setup of order code number		
Type	Switching progr.	Mtg. form
K616	41300	034N1
Order code no.	K616-41300-034N1	

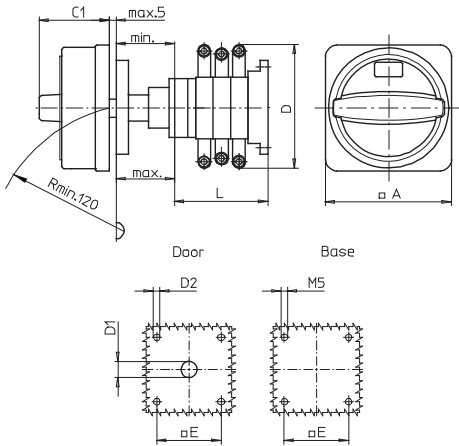

Type K616:

Mtg. form	Switching progr.	A	C1	D*	D1	D2	E	min	max	L
034M1	41300	88	50	150	15	5.5	68	48	60	104
034M1	41400	88	50	150	15	5.5	68	48	60	104
034M1	41600	88	50	150	15	5.5	68	48	60	136
034M1	41800	88	50	150	15	5.5	68	48	60	168
034N1	41300	88	45	150	15	5.5	68	48	60	104
034N1	41400	88	45	150	15	5.5	68	48	60	104
034N1	41600	88	45	150	15	5.5	68	48	60	136
034N1	41800	88	45	150	15	5.5	68	48	60	168

Type K616:

Mtg. form	Switching progr.	A1	A2	C1	D*	D1	D2	E	min	max	L
034H1	41300	98	142	83	150	15	5.5	68	48	60	104
034H1	41400	98	142	83	150	15	5.5	68	48	60	104
034H1	41600	98	142	83	150	15	5.5	68	48	60	136
034H1	41800	98	142	83	150	15	5.5	68	48	60	168

Type K830:

Mtg. form	Switching progr.	A1	A2	C1	D*	D1	D2	E	min	max	L
034H1	41300	130	176	93	210	20	5.5	104	75	102	125
034H1	41400	130	176	93	210	20	5.5	104	75	102	125
034H1	41600	130	176	93	210	20	5.5	104	75	102	161
034H1	41800	130	176	93	210	20	5.5	104	75	102	197

* terminal lugs included

Further switching programmes and corresponding dimensions for types K on request.

Main Switches

- Enclosed switches with insulated enclosure (polycarbonate)
- Cover interlock in ON position
- 3 up to 8 pole
- 20 A up to 315 A
- IP66



Switching programme	Rated data (IEC 60947)			Enclosure dimension (H x W x D) (mm)	Padlock device N-handle black	Padlock device M-handle black	Padlockable handle V-handle silver/black
	Operat. current I _e (A)	Operational power (at 380–440 V) (kW)					
	AC-21A (A)	AC-23A (kW)	AC-3 (kW)		IP66	IP66	IP66
					Order code number	Order code number	Order code number
41300 – 3 pole – without auxiliary contacts 	20	5.5	3.7	125 x 100 x 85	H216-41300-700N1	H216-41300-700M1	H216-41300-700V1
	20	5.5	3.7	175 x 115 x 100	H216-41300-710N1	H216-41300-710M1	H216-41300-710V1
	20	5.5	3.7	250 x 160 x 120	H216-41300-730N1	H216-41300-730M1	H216-41300-730V1
	25	7.5	5.5	125 x 100 x 85	H220-41300-700N1	H220-41300-700M1	H220-41300-700V1
	25	7.5	5.5	175 x 115 x 100	H220-41300-710N1	H220-41300-710M1	H220-41300-710V1
	25	7.5	5.5	250 x 160 x 120	H220-41300-730N1	H220-41300-730M1	H220-41300-730V1
	32	11	7.5	125 x 100 x 85	H226-41300-700N1	H226-41300-700M1	H226-41300-700V1
	32	11	7.5	175 x 115 x 100	H226-41300-710N1	H226-41300-710M1	H226-41300-710V1
	32	11	7.5	250 x 160 x 120	H226-41300-730N1	H226-41300-730M1	H226-41300-730V1
	40	15	11	175 x 115 x 100	H233-41300-710N1	H233-41300-710M1	H233-41300-710V1
	40	15	11	175 x 115 x 100	B240-41300-710N1*¹	B240-41300-710M1*¹	B240-41300-710V1*¹
	40	15	11	250 x 160 x 120	H233-41300-730N1	H233-41300-730M1	H233-41300-730V1
	40	15	11	250 x 160 x 120	B240-41300-730N1*	B240-41300-730M1*	B240-41300-730V1*
	50	18.5	15	175 x 115 x 100	B250-41300-710N1¹	B250-41300-710M1¹	B250-41300-710V1¹
	50	18.5	15	250 x 160 x 120	B250-41300-730N1	B250-41300-730M1	B250-41300-730V1
	63	22	18.5	175 x 115 x 100	B263-41300-710N1¹	B263-41300-710M1¹	B263-41300-710V1¹
	63	22	18.5	250 x 160 x 120	B263-41300-730N1	B263-41300-730M1	B263-41300-730V1
	63	22	18.5	250 x 160 x 120	H406-41300-730N1*	H406-41300-730M1*	–
	63	22	18.5	280 x 190 x 130	H406-41300-770N1	H406-41300-770M1	H406-41300-770V1
	63	22	18.5	320 x 220 x 180	H406-41300-477N1	H406-41300-477M1	–
80	30	22	250 x 160 x 120	H408-41300-730N1	H408-41300-730M1	–	
80	30	22	280 x 190 x 130	H408-41300-770N1	H408-41300-770M1	H408-41300-770V1	
80	30	22	320 x 220 x 180	H408-41300-477N1	H408-41300-477M1	–	
100	37	30	250 x 160 x 120	H410-41300-730N1	H410-41300-730M1	–	
100	37	30	280 x 190 x 130	H410-41300-770N1	H410-41300-770M1	H410-41300-770V1	
100	37	30	320 x 220 x 180	H410-41300-477N1	H410-41300-477M1	–	
125	45	37	320 x 220 x 180	H412-41300-477N1	H412-41300-477M1	–	

* larger terminal capacity, see page 154



¹ Terminal capacity max. 16 mm² on N-terminal and/or PE-terminal

Further switching programmes as of page 132.

Rated data (IEC 60947)			Enclosure dimension (H x W x D) (mm)	Padlock device H-handle silver/black
Operat. current I _e (A)	Operational power (at 380–440 V) (kW)			
AC-21A (A)	AC-23A (kW)	AC-3 (kW)		IP66
				Order code number
160	75	45	440 x 320 x 180	K616-41300-077H1
160	75	45	440 x 320 x 255	K616-41300-177H1
315	132	55	640 x 320 x 255	K830-41300-077H1
315	132	55	640 x 320 x 330	K830-41300-177H1

Disconnect Switches

Main Switches Enclosed Switches – Insulated Enclosure

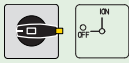
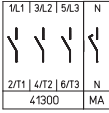
Switching programme	Rated data (IEC 60947)			Enclosure dimension (H × W × D) (mm)	Padlock device N-handle black	Padlock device M-handle black	Padlockable handle V-handle silver/black
	Operat. current I _e (A)	Operational power (at 380–440 V) (kW)			 IP66	 IP66	 IP66
		AC-21A	AC-23A		AC-3	Order code number	Order code number
41400 – 4 pole – without auxiliary contacts – neutral contact – early make/late break 	20	5.5	3.7	125 × 100 × 85	H216-41400-700N1	H216-41400-700M1	H216-41400-700V1
	20	5.5	3.7	175 × 115 × 100	H216-41400-710N1	H216-41400-710M1	H216-41400-710V1
	20	5.5	3.7	250 × 160 × 120	H216-41400-730N1	H216-41400-730M1	H216-41400-730V1
	25	7.5	5.5	125 × 100 × 85	H220-41400-700N1	H220-41400-700M1	H220-41400-700V1
	25	7.5	5.5	175 × 115 × 100	H220-41400-710N1	H220-41400-710M1	H220-41400-710V1
	25	7.5	5.5	250 × 160 × 120	H220-41400-730N1	H220-41400-730M1	H220-41400-730V1
	32	11	7.5	125 × 100 × 85	H226-41400-700N1	H226-41400-700M1	H226-41400-700V1
	32	11	7.5	175 × 115 × 100	H226-41400-710N1	H226-41400-710M1	H226-41400-710V1
	32	11	7.5	250 × 160 × 120	H226-41400-730N1	H226-41400-730M1	H226-41400-730V1
	40	15	11	175 × 115 × 100	H233-41400-710N1	H233-41400-710M1	H233-41400-710V1
	40	15	11	175 × 115 × 100	B240-41400-710N1*¹	B240-41400-710M1*¹	B240-41400-710V1*¹
	40	15	11	250 × 160 × 120	H233-41400-730N1	H233-41400-730M1	H233-41400-730V1
	40	15	11	250 × 160 × 120	B240-41400-730N1*	B240-41400-730M1*	B240-41400-730V1*
	50	18.5	15	175 × 115 × 100	B250-41400-710N1¹	B250-41400-710M1¹	B250-41400-710V1¹
	50	18.5	15	250 × 160 × 120	B250-41400-730N1	B250-41400-730M1	B250-41400-730V1
	63	22	18.5	175 × 115 × 100	B263-41400-710N1¹	B263-41400-710M1¹	B263-41400-710V1¹
	63	22	18.5	250 × 160 × 120	B263-41400-730N1	B263-41400-730M1	B263-41400-730V1
	63	22	18.5	250 × 160 × 120	H406-41400-730N1*	H406-41400-730M1*	–
	63	22	18.5	280 × 190 × 130	H406-41400-770N1	H406-41400-770M1	H406-41400-770V1
	63	22	18.5	320 × 220 × 180	H406-41400-477N1	H406-41400-477M1	–
	80	30	22	250 × 160 × 120	H408-41400-730N1	H408-41400-730M1	–
	80	30	22	280 × 190 × 130	H408-41400-770N1	H408-41400-770M1	H408-41400-770V1
	80	30	22	320 × 220 × 180	H408-41400-477N1	H408-41400-477M1	–
	100	37	30	250 × 160 × 120	H410-41400-730N1	H410-41400-730M1	–
	100	37	30	280 × 190 × 130	H410-41400-770N1	H410-41400-770M1	H410-41400-770V1
	100	37	30	320 × 220 × 180	H410-41400-477N1	H410-41400-477M1	–
	125	45	37	320 × 220 × 180	H412-41400-477N1	H412-41400-477M1	–

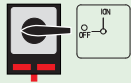
Rated data (IEC 60947)			Enclosure dimension (H × W × D) (mm)	Padlock device H-handle silver/black
Operat. current I _e (A)	Operational power (at 380–440 V) (kW)			 IP66
	AC-21A	AC-23A	AC-3	Order code number
160	75	45	440 × 320 × 180	K616-41400-077H1
160	75	45	440 × 320 × 255	K616-41400-177H1
315	132	55	640 × 320 × 255	K830-41400-077H1
315	132	55	640 × 320 × 330	K830-41400-177H1

* larger terminal capacity, see page 154

¹ Terminal capacity max. 16 mm² on N-terminal and/or PE-terminal

Further switching programmes from page 132.

Switching programme	Rated data (IEC 60947)			Enclosure dimension (H × W × D) (mm)	Padlock device N-handle black	Padlock device M-handle black	Padlockable handle V-handle silver/black
	Operat. current I_e	Operational power (at 380–440 V)			IP66	IP66	IP66
	AC-21A (A)	AC-23A (kW)	AC-3 (kW)		Order code number	Order code number	Order code number
41600 – 6 pole – without auxiliary contacts 	20	5.5	3.7	175 × 115 × 100	H216-41600-720N1	H216-41600-720M1	H216-41600-720V1
	20	5.5	3.7	250 × 160 × 120	H216-41600-733N1	H216-41600-733M1	H216-41600-733V1
	25	7.5	5.5	175 × 115 × 100	H220-41600-720N1	H220-41600-720M1	H220-41600-720V1
	25	7.5	5.5	250 × 160 × 120	H220-41600-733N1	H220-41600-733M1	H220-41600-733V1
	32	11	7.5	175 × 115 × 100	H226-41600-720N1	H226-41600-720M1	H226-41600-720V1
	32	11	7.5	250 × 160 × 120	H226-41600-733N1	H226-41600-733M1	H226-41600-733V1
	40	15	11	175 × 115 × 100	H233-41600-720N1	H233-41600-720M1	H233-41600-720V1
	40	15	11	250 × 160 × 120	H233-41600-733N1	H233-41600-733M1	H233-41600-733V1
	40	15	11	320 × 220 × 180	B240-41600-977N1	B240-41600-977M1	–
	50	18.5	15	320 × 220 × 180	B250-41600-977N1	B250-41600-977M1	–
	63	22	18.5	320 × 220 × 180	B263-41600-977N1	B263-41600-977M1	–
	63	22	18.5	320 × 220 × 180	H406-41600-977N1*	H406-41600-977M1*	–
	63	22	18.5	440 × 320 × 180	H406-41600-577N1	H406-41600-577M1	–
	80	30	22	320 × 220 × 180	H408-41600-977N1	H408-41600-977M1	–
	80	30	22	440 × 320 × 180	H408-41600-577N1	H408-41600-577M1	–
	100	37	30	320 × 220 × 180	H410-41600-977N1	H410-41600-977M1	–
	100	37	30	440 × 320 × 180	H410-41600-577N1	H410-41600-577M1	–
125	45	37	320 × 220 × 180	H412-41600-577N1	H412-41600-977M1	–	
125	45	37	440 × 320 × 180	H412-41600-577N1	H412-41600-577M1	–	



Rated data (IEC 60947)			Enclosure dimension (H × W × D) (mm)	Padlock device H-handle silver/black
Operat. current I_e	Operational power (at 380–440 V)			IP66
AC-21A (A)	AC-23A (kW)	AC-3 (kW)		Order code number
160	75	45	440 × 320 × 255	K616-41600-177H1
315	132	55	640 × 320 × 330	K830-41600-177H1

* larger terminal capacity, see page 154

Further switching programmes from page 132.

Disconnect Switches

Main Switches Enclosed Switches – Insulated Enclosure

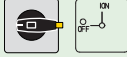
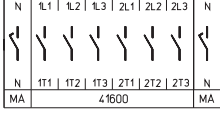
Switching programme	Rated data (IEC 60947)			Enclosure dimension (H × W × D) (mm)	Padlock device N-handle black	Padlock device M-handle black	Padlockable handle V-handle silver/black
	Operat. current I _e (A)	Operational power (at 380–440 V) (kW)			 IP66	 IP66	 IP66
		AC-21A	AC-23A		AC-3	Order code number	Order code number
41800 – 8 pole – without auxiliary contacts – 2 neutral contacts – early make/late break 	20	5.5	3.7	250 × 160 × 120	H216-41800-733N1	H216-41800-733M1	H216-41800-733V1
	20	5.5	3.7	280 × 190 × 130	H216-41800-770N1	H216-41800-770M1	H216-41800-770V1
	25	7.5	5.5	250 × 160 × 120	H220-41800-733N1	H220-41800-733M1	H220-41800-733V1
	25	7.5	5.5	280 × 190 × 130	H220-41800-770N1	H220-41800-770M1	H220-41800-770V1
	32	11	7.5	250 × 160 × 120	H226-41800-733N1	H226-41800-733M1	H226-41800-733V1
	32	11	7.5	280 × 190 × 130	H226-41800-770N1	H226-41800-770M1	H226-41800-770V1
	40	15	11	250 × 160 × 120	H233-41800-733N1	H233-41800-733M1	H233-41800-733V1
	40	15	11	280 × 190 × 130	H233-41800-770N1	H233-41800-770M1	H233-41800-770V1
	40	15	11	280 × 190 × 130	B240-41800-770N1 * ¹	B240-41800-770M1 * ¹	B240-41800-770V1 * ¹
	40	15	11	320 × 220 × 180	B240-41800-977N1	B240-41800-977M1	–
	50	18.5	15	280 × 190 × 130	B250-41800-770N1 ¹	B250-41800-770M1 ¹	B250-41800-770V1 ¹
	50	18.5	15	320 × 220 × 180	B250-41800-977N1	B250-41800-977M1	–
	63	22	18.5	280 × 190 × 130	B263-41800-770N1 ¹	B263-41800-770M1 ¹	B263-41800-770V1 ¹
	63	22	18.5	320 × 220 × 180	B263-41800-977N1	B263-41800-977M1	–
	63	22	18.5	320 × 220 × 180	H406-41800-977N1 *	H406-41800-977M1 *	–
	63	22	18.5	440 × 320 × 180	H406-41800-577N1	H406-41800-577M1	–
	80	30	22	320 × 220 × 180	H408-41800-977N1	H408-41800-977M1	–
	80	30	22	440 × 320 × 180	H408-41800-577N1	H408-41800-577M1	–
	100	37	30	320 × 220 × 180	H410-41800-977N1	H410-41800-977M1	–
	100	37	30	440 × 320 × 180	H410-41800-577N1	H410-41800-577M1	–
125	45	37	320 × 220 × 180	H412-41800-977N1	H412-41800-977M1	–	
125	45	37	440 × 320 × 180	H412-41800-577N1	H412-41800-577M1	–	

Rated data (IEC 60947)			Enclosure dimension (H × W × D) (mm)	Padlock device H-handle silver/black
Operat. current I _e (A)	AC-21A	AC-23A		AC-3 (kW)
				Order code number
160	75	45	440 × 320 × 255	K616-41800-177H1
315	132	55	640 × 320 × 330	K830-41800-177H1

* larger terminal capacity, see page 154

¹ Terminal capacity max. 16 mm² on N-terminal and/or PE-terminal

Further switching programmes from page 132.

Dimensions in mm:

Setup of order code number

Type	Switching progr.	Mtg. form
H216	41400	700M1
Order code no.	H216-41400-700M1	

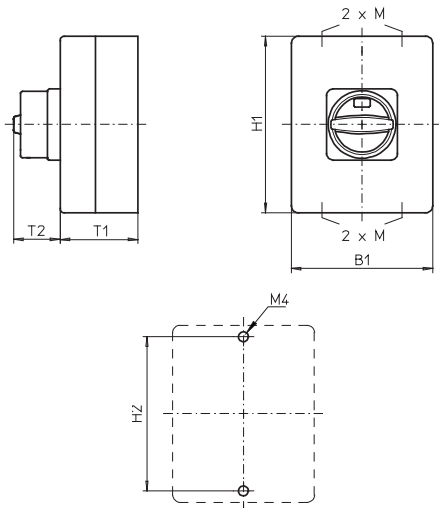

Insulated enclosures **125 × 100 × 85 mm**
and **175 × 115 × 100 mm**:

Types H216 / H220 / H226 / H233 / B240 / B250 / B263:

Mtg. form	H1	B1	T1	T2	2×M	H2
700M1	125	100	85	38	20/25	115
700N1	125	100	85	33	20/25	115
700V1	125	100	85	32	20/25	115
710M1	175	115	100	38	20/25	165
710N1	175	115	100	33	20/25	165
710V1	175	115	100	39	20/25	165
720M1	175	115	100	38	20/25	165
720N1	175	115	100	33	20/25	165
720V1	175	115	100	39	20/25	165

Insulated enclosure **250 × 160 × 120 mm**:

Types H216 / H220 / H226 / H233:

Mtg. form	H1	B1	T1	T2	2×M	H2
730M1	250	160	120	38	32/40	235
730N1	250	160	120	33	32/40	235
730V1	250	160	120	39	32/40	235
733M1	250	160	120	38	32/40	235
733N1	250	160	120	33	32/40	235
733V1	250	160	120	39	32/40	235

Types B240 / B250 / B263:

Mtg. form	H1	B1	T1	T2	2×M	H2
730M1	250	160	120	50	32/40	235
730N1	250	160	120	45	32/40	235
730V1	250	160	120	39	32/40	235

Types H406 / H408 / H410 / H412:

Mtg. form	H1	B1	T1	T2	2×M	H2
730M1	250	160	120	50	32/40	235
730N1	250	160	120	45	32/40	235

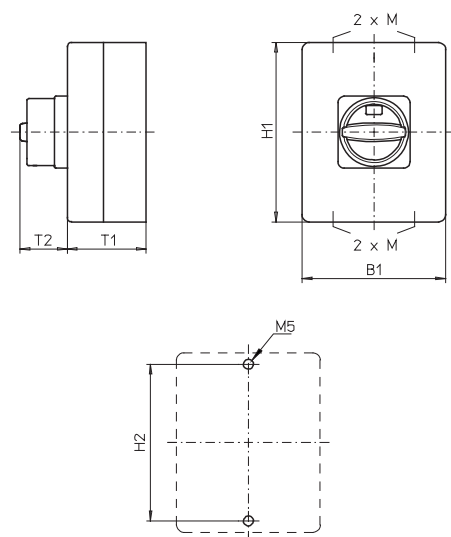

Disconnect Switches

Main Switches Enclosed Switches – Insulated Enclosure

Dimensions in mm:

Setup of order code number

Type	Switching progr.	Mtg. form
H406	41300	770M1
Order code no.	H406-41300-770M1	

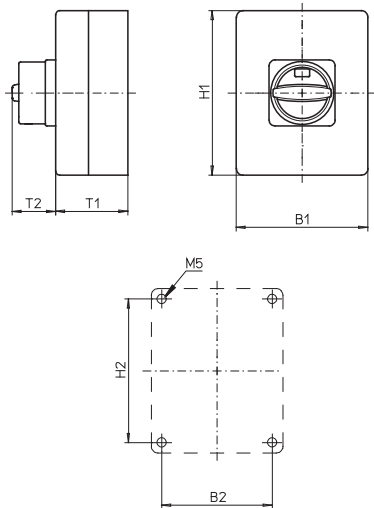

Insulated enclosures **280 × 190 × 130 mm**
and **320 × 220 × 180 mm**:

Types H216 / H220 / H226 / H233 / B240 / B250 / B263 /
H406 / H408 / H410 / H412:

Mtg. form	H1	B1	T1	T2	2×M	H2	B2
770M1	280	190	130	50	40×1.5	254	164
770N1	280	190	130	45	40×1.5	254	164
770V1	280	190	130	39	40×1.5	254	164
477M1	320	220	180	50	50 ¹	293	193
477N1	320	220	180	45	50 ¹	293	193
977M1	320	220	180	50	– ²	293	193
977N1	320	220	180	45	– ²	293	193

¹ Gland plates with knockouts

² Blank gland plates

Insulated enclosures **440 × 320 × 180 mm /**
440 × 320 × 255 mm / 640 × 320 × 255 mm /
640 × 320 × 330 mm:

Types H406 / H408 / H410 / H412:

Mtg. form	H1	B1	T1	T2	H2	B2
577M1	440	320	180	50	480	293
577N1	440	320	180	45	480	293

Type K616:

Mtg. form	H1	B1	T1	T2	H2	B2
077H1	440	320	180	83	480	293
177H1	440	320	255	83	480	293

Type K830:

Mtg. form	H1	B1	T1	T2	H2	B2
077H1	640	320	255	93	680	293
177H1	640	320	330	93	680	293

Further switching programmes and corresponding dimensions for types K on request.

Blank gland plates

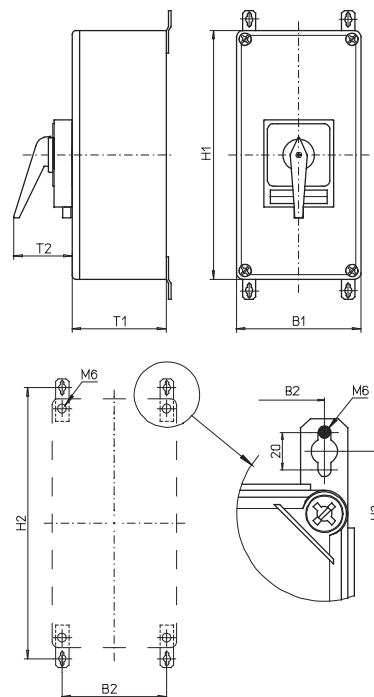

Mounting brackets are included.

Main Switches

- Enclosed switches with insulated enclosure (polycarbonate)
- EMV/EMC application, connection system for the uninterrupted connection of shielded/screened cables consisting of shroud and 4 shroud clamps \varnothing 12–16 mm
- Cover interlock in ON position
- 3 up to 6 pole
- 20 A up to 63 A
- IP66



Switching programme	Rated data (IEC 60947)			Enclosure dimension (H x W x D) (mm)	Padlock device N-handle black	Padlock device M-handle black	Padlockable handle V-handle silver/black
	Operat. current I _e	Operational power (at 380–440 V)					
	AC-21A (A)	AC-23A (kW)	AC-3 (kW)		IP66	IP66	IP66
				Order code number	Order code number	Order code number	
41300 – 3 pole – without auxiliary contacts 	20	5.5	3.7	175 x 115 x 100	H216-41300-715N1	H216-41300-715M1	H216-41300-715V1
	25	7.5	5.5	175 x 115 x 100	H220-41300-715N1	H220-41300-715M1	H220-41300-715V1
	32	11	7.5	175 x 115 x 100	H226-41300-715N1	H226-41300-715M1	H226-41300-715V1
	40	15	11	175 x 115 x 100	H233-41300-715N1	H233-41300-715M1	H233-41300-715V1
	40	15	11	175 x 115 x 100	B240-41300-715N1*	B240-41300-715M1*	B240-41300-715V1*
	50	18.5	15	175 x 115 x 100	B250-41300-715N1	B250-41300-715M1	B250-41300-715V1
	63	22	18.5	175 x 115 x 100	B263-41300-715N1	B263-41300-715M1	B263-41300-715V1
41400 – 4 pole – without auxiliary contacts – neutral contact early make/late break 	20	5.5	3.7	175 x 115 x 100	H216-41400-715N1	H216-41400-715M1	H216-41400-715V1
	25	7.5	5.5	175 x 115 x 100	H220-41400-715N1	H220-41400-715M1	H220-41400-715V1
	32	11	7.5	175 x 115 x 100	H226-41400-715N1	H226-41400-715M1	H226-41400-715V1
	40	15	11	175 x 115 x 100	H233-41400-715N1	H233-41400-715M1	H233-41400-715V1
	40	15	11	175 x 115 x 100	B240-41400-715N1*	B240-41400-715M1*	B240-41400-715V1*
	50	18.5	15	175 x 115 x 100	B250-41400-715N1	B250-41400-715M1	B250-41400-715V1
	63	22	18.5	175 x 115 x 100	B263-41400-715N1	B263-41400-715M1	B263-41400-715V1
41600 – 6 pole – without auxiliary contacts 	20	5.5	3.7	175 x 115 x 100	H216-41600-725N1	H216-41600-725M1	H216-41600-725V1
	25	7.5	5.5	175 x 115 x 100	H220-41600-725N1	H220-41600-725M1	H220-41600-725V1
	32	11	7.5	175 x 115 x 100	H226-41600-725N1	H226-41600-725M1	H226-41600-725V1
	40	15	11	175 x 115 x 100	H233-41600-725N1	H233-41600-725M1	H233-41600-725V1

* larger terminal capacity, see page 154

Further switching programmes from page 132.

Dimensions in mm:

Types H216 / H220 / H226 / H233 / B240 / B250 / B263:

Mtg. form	H1	B1	T1	T2	2xM	H2
715M1	175	115	100	38	20/25	165
715N1	175	115	100	33	20/25	165
715V1	175	115	100	39	20/25	165
725M1	175	115	100	38	20/25	165
725N1	175	115	100	33	20/25	165
725V1	175	115	100	39	20/25	165





Disconnect Switches

Main Switches Enclosed Switches – Mild Steel Enclosure

Main Switches

- Enclosed switches with mild steel enclosure (powder coated – RAL 7035)
- Cover interlock in ON position
- 3 up to 8 pole
- 20 A up to 315 A
- IP66

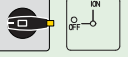

Switching programme	Rated data (IEC 60947)			Enclosure dimension (H x W x D) (mm)	Padlock device N-handle black	Padlock device M-handle black	Padlockable handle V-handle silver/black
	Operat. current I _e (A)	Operational power (at 380–440 V) (kW)			 IP66	 IP66	 IP66
	AC-21A (A)	AC-23A (kW)	AC-3 (kW)		Order code number	Order code number	Order code number
41300 – 3 pole – without auxiliary contacts 	20	5.5	3.7	150 x 150 x 120	H216-41300-087N1	H216-41300-087M1	H216-41300-087V1
	20	5.5	3.7	200 x 150 x 120	H216-41300-187N1	H216-41300-187M1	H216-41300-187V1
	25	7.5	5.5	150 x 150 x 120	H220-41300-087N1	H220-41300-087M1	H220-41300-087V1
	25	7.5	5.5	200 x 150 x 120	H220-41300-187N1	H220-41300-187M1	H220-41300-187V1
	32	11	7.5	150 x 150 x 120	H226-41300-087N1	H226-41300-087M1	H226-41300-087V1
	32	11	7.5	200 x 150 x 120	H226-41300-187N1	H226-41300-187M1	H226-41300-187V1
	40	15	11	200 x 150 x 120	H233-41300-187N1	H233-41300-187M1	H233-41300-187V1
	40	15	11	200 x 150 x 120	B240-41300-087N1*	B240-41300-087M1*	B240-41300-087V1*
	50	18.5	15	200 x 150 x 120	B250-41300-087N1	B250-41300-087M1	B250-41300-087V1
	63	22	18.5	200 x 150 x 120	B263-41300-087N1	B263-41300-087M1	B263-41300-087V1
	63	22	18.5	200 x 150 x 120	H406-41300-987N1*	H406-41300-987M1*	–
	63	22	18.5	300 x 250 x 150	H406-41300-187N1	H406-41300-187M1	–
	63	22	18.5	400 x 300 x 155	H406-41300-182N1¹	H406-41300-182M1¹	–
	80	30	22	200 x 150 x 120	H408-41300-987N1	H408-41300-987M1	–
	80	30	22	300 x 250 x 150	H408-41300-187N1	H408-41300-187M1	–
	80	30	22	400 x 300 x 155	H408-41300-182N1¹	H408-41300-182M1¹	–
100	37	30	300 x 250 x 150	H410-41300-187N1	H410-41300-187M1	–	
100	37	30	400 x 300 x 155	H410-41300-182N1¹	H410-41300-182M1¹	–	
125	45	37	300 x 250 x 150	H412-41300-187N1	H412-41300-187M1	–	
125	45	37	400 x 300 x 155	H412-41300-182N1¹	H412-41300-182M1¹	–	

Rated data (IEC 60947)			Enclosure dimension (H x W x D) (mm)	Padlock device H-handle silver/black
Operat. current I _e (A)	Operational power (at 380–440 V) (kW)			 IP66
AC-21A (A)	AC-23A (kW)	AC-3 (kW)		Order code number
160	75	45	500 x 400 x 300	K616-41300-187H1¹
315	132	55	600 x 400 x 300	K830-41300-187H1¹
315	132	55	800 x 400 x 300	K830-41300-287H1¹

* larger terminal capacity, see page 154



¹ hinged door

Further switching programmes from page 132.

Disconnect Switches



Main Switches Enclosed Switches – Mild Steel Enclosure

Switching programme	Rated data (IEC 60947)			Enclosure dimension (H × W × D) (mm)	Padlock device N-handle black	Padlock device M-handle black	Padlockable handle V-handle silver/black
	Operat. current I _e	Operational power (at 380–440 V)			 IP66	 IP66	 IP66
	AC-21A (A)	AC-23A (kW)	AC-3 (kW)		Order code number	Order code number	Order code number
41400 – 4 pole – without auxiliary contacts – neutral contact – early make/late break	20	5.5	3.7	150 × 150 × 120	H216-41400-087N1	H216-41400-087M1	H216-41400-087V1
	20	5.5	3.7	200 × 150 × 120	H216-41400-187N1	H216-41400-187M1	H216-41400-187V1
	25	7.5	5.5	150 × 150 × 120	H220-41400-087N1	H220-41400-087M1	H220-41400-087V1
	25	7.5	5.5	200 × 150 × 120	H220-41400-187N1	H220-41400-187M1	H220-41400-187V1
	32	11	7.5	150 × 150 × 120	H226-41400-087N1	H226-41400-087M1	H226-41400-087V1
	32	11	7.5	200 × 150 × 120	H226-41400-187N1	H226-41400-187M1	H226-41400-187V1
	40	15	11	200 × 150 × 120	H233-41400-187N1	H233-41400-187M1	H233-41400-187V1
	40	15	11	200 × 150 × 120	B240-41400-087N1*	B240-41400-087M1*	B240-41400-087V1*
	50	18.5	15	200 × 150 × 120	B250-41400-087N1	B250-41400-087M1	B250-41400-087V1
	63	22	18.5	200 × 150 × 120	B263-41400-087N1	B263-41400-087M1	B263-41400-087V1
	63	22	18.5	200 × 150 × 120	H406-41400-987N1*	H406-41400-987M1*	–
	63	22	18.5	300 × 250 × 150	H406-41400-187N1	H406-41400-187M1	–
	63	22	18.5	400 × 300 × 155	H406-41400-182N1 ¹	H406-41400-182M1 ¹	–
	80	30	22	200 × 150 × 120	H408-41400-987N1	H408-41400-987M1	–
80	30	22	300 × 250 × 150	H408-41400-187N1	H408-41400-187M1	–	
80	30	22	400 × 300 × 155	H408-41400-182N1 ¹	H408-41400-182M1 ¹	–	
100	37	30	300 × 250 × 150	H410-41400-187N1	H410-41400-187M1	–	
100	37	30	400 × 300 × 155	H410-41400-182N1 ¹	H410-41400-182M1 ¹	–	
125	45	37	300 × 250 × 150	H412-41400-187N1	H412-41400-187M1	–	
125	45	37	400 × 300 × 155	H412-41400-182N1 ¹	H412-41400-182M1 ¹	–	

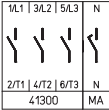

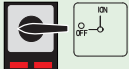
Rated data (IEC 60947)			Enclosure dimension (H × W × D) (mm)	Padlock device H-handle silver/black	
Operat. current I _e	Operational power (at 380–440 V)			 IP66	
AC-21A (A)	AC-23A (kW)	AC-3 (kW)		Order code number	
160	75	45	500 × 400 × 300	K616-41400-187H1 ¹	
315	132	55	600 × 400 × 300	K830-41400-187H1 ¹	
315	132	55	800 × 400 × 300	K830-41400-287H1 ¹	



* larger terminal capacity, see page 154

¹ hinged door

Further switching programmes from page 132.

Disconnect Switches

Main Switches Enclosed Switches – Mild Steel Enclosure

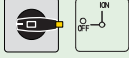
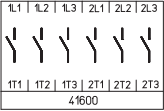
Switching programme	Rated data (IEC 60947)			Enclosure dimension (H × W × D) (mm)	Padlock device N-handle black	Padlock device M-handle black	Padlockable handle V-handle silver/black
	Operat. current I_e	Operational power (at 380–440 V)			 IP66	 IP66	 IP66
	AC-21A (A)	AC-23A (kW)	AC-3 (kW)		Order code number	Order code number	Order code number
41600 – 6 pole – without auxiliary contacts 	20	5.5	3.7	200 × 150 × 120	H216-41600-187N1	H216-41600-187M1	H216-41600-187V1
	25	7.5	5.5	200 × 150 × 120	H220-41600-187N1	H220-41600-187M1	H220-41600-187V1
	32	11	7.5	200 × 150 × 120	H226-41600-187N1	H226-41600-187M1	H226-41600-187V1
	40	15	11	200 × 150 × 120	H233-41600-187N1	H233-41600-187M1	H233-41600-187V1
	40	15	11	300 × 250 × 150	B240-41600-187N1	B240-41600-187M1	–
	50	18.5	15	300 × 250 × 150	B250-41600-187N1	B250-41600-187M1	–
	63	22	18.5	300 × 250 × 150	B263-41600-187N1	B263-41600-187M1	–
	63	22	18.5	300 × 250 × 150	H406-41600-187N1*	H406-41600-187M1*	–
	63	22	18.5	400 × 300 × 155	H406-41600-182N1¹	H406-41600-182M1¹	–
	80	30	22	300 × 250 × 150	H408-41600-187N1	H408-41600-187M1	–
	80	30	22	400 × 300 × 155	H408-41600-182N1¹	H408-41600-182M1¹	–
	100	37	30	300 × 250 × 150	H410-41600-187N1	H410-41600-187M1	–
	100	37	30	400 × 300 × 155	H410-41600-182N1¹	H410-41600-182M1¹	–
	125	45	37	300 × 250 × 150	H412-41600-187N1	H412-41600-187M1	–
	125	45	37	400 × 300 × 155	H412-41600-182N1¹	H412-41600-182M1¹	–

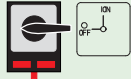
Rated data (IEC 60947)			Enclosure dimension (H × W × D) (mm)	Padlock device H-handle silver/black
Operat. current I_e	Operational power (at 380–440 V)			 IP66
AC-21A (A)	AC-23A (kW)	AC-3 (kW)		Order code number
160	75	45	500 × 400 × 300	K616-41600-187H1¹
315	132	55	600 × 400 × 300	K830-41600-187H1¹
315	132	55	800 × 400 × 300	K830-41600-287H1¹

* larger terminal capacity, see page 154



¹ hinged door

Further switching programmes from page 132.

Disconnect Switches

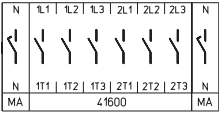

Main Switches Enclosed Switches – Mild Steel Enclosure

Switching programme	Rated data (IEC 60947)			Enclosure dimension (H × W × D) (mm)	Padlock device N-handle black	Padlock device M-handle black	Padlockable handle V-handle silver/black
	Operat. current I _e (A)	Operational power (at 380–440 V) AC-23A (kW)	AC-3 (kW)		 OFF ON IP66	 OFF ON IP66	 OFF ON IP66
	AC-21A (A)	AC-23A (kW)	AC-3 (kW)		Order code number	Order code number	Order code number
41800 – 8 pole – without auxiliary contacts – 2 neutral contacts early make/late break 	20	5.5	3.7	200 × 150 × 120	H216-41800-187N1	H216-41800-187M1	H216-41800-187V1
	25	7.5	5.5	200 × 150 × 120	H220-41800-187N1	H220-41800-187M1	H220-41800-187V1
	32	11	7.5	200 × 150 × 120	H226-41800-187N1	H226-41800-187M1	H226-41800-187V1
	40	15	11	200 × 150 × 120	H233-41800-187N1	H233-41800-187M1	H233-41800-187V1
	40	15	11	300 × 250 × 150	B240-41800-187N1	B240-41800-187M1	–
	50	18.5	15	300 × 250 × 150	B250-41800-187N1	B250-41800-187M1	–
	63	22	18.5	300 × 250 × 150	B263-41800-187N1	B263-41800-187M1	–
	63	22	18.5	300 × 250 × 150	H406-41800-187N1*	H406-41800-187M1*	–
	63	22	18.5	400 × 300 × 155	H406-41800-182N1¹	H406-41800-182M1¹	–
	80	30	22	300 × 250 × 150	H408-41800-187N1	H408-41800-187M1	–
	80	30	22	400 × 300 × 155	H408-41800-182N1¹	H408-41800-182M1¹	–
	100	37	30	300 × 250 × 150	H410-41800-187N1	H410-41800-187M1	–
	100	37	30	400 × 300 × 155	H410-41800-182N1¹	H410-41800-182M1¹	–
	125	45	37	300 × 250 × 150	H412-41800-187N1	H412-41800-187M1	–
	125	45	37	400 × 300 × 155	H412-41800-182N1¹	H412-41800-182M1¹	–

Rated data (IEC 60947)			Enclosure dimension (H × W × D) (mm)	Padlock device H-handle silver/black
Operat. current I _e (A)	Operational power (at 380–440 V) AC-23A (kW)	AC-3 (kW)		 OFF ON IP66
AC-21A (A)	AC-23A (kW)	AC-3 (kW)		Order code number
160	75	45	500 × 400 × 300	K616-41800-187H1¹
315	132	55	600 × 400 × 300	K830-41800-187H1¹
315	132	55	800 × 400 × 300	K830-41800-287H1¹

* larger terminal capacity, see page 154

¹ hinged door

Further switching programmes from page 132.

Disconnect Switches

Main Switches Enclosed Switches – Mild Steel Enclosure

Dimensions in mm:

Setup of order code number

Type	Switching progr.	Mtg. form
H216	41400	087M1
Order code no.	H216-41400-087M1	

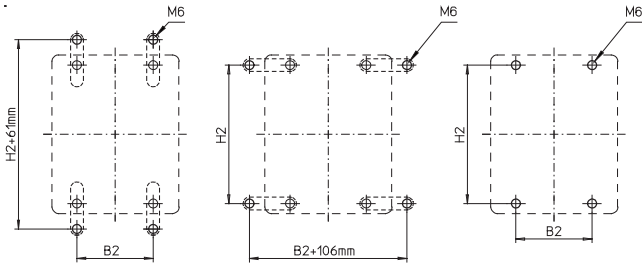
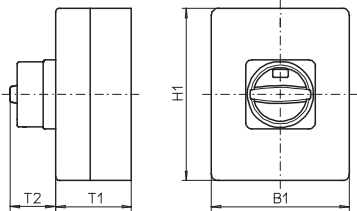

Please order mounting brackets separately, see page 148.

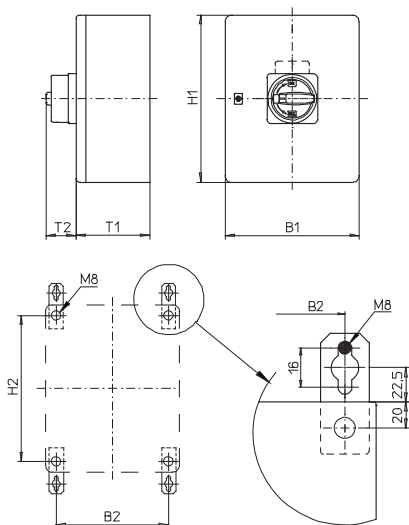

Please order mounting brackets separately, see page 148.

Mild steel enclosure **150 × 150 × 120 mm / 200 × 150 × 120 mm / 300 × 250 × 150 mm:**

Types H216 / H220 / H226 / H233:

Mtg. form	H1	B1	T1	T2	H2	B2
087M1	150	150	120	38	132	85
087N1	150	150	120	33	132	85
087V1	150	150	120	39	132	85
187M1	200	150	120	38	182	85
187N1	200	150	120	33	182	85
187V1	200	150	120	39	182	85

Types B240 / B250 / B263:

Mtg. form	H1	B1	T1	T2	H2	B2
087M1	200	150	120	38	182	85
087N1	200	150	120	33	182	85
087V1	200	150	120	39	182	85
187M1	300	250	150	50	282	185
187N1	300	250	150	45	282	185

Types H406 / H408 / H410 / H412:

Mtg. form	H1	B1	T1	T2	H2	B2
187M1	300	250	150	50	282	185
187N1	300	250	150	45	282	185
987M1	200	150	120	50	182	85
987N1	200	150	120	45	182	85

Mild steel enclosure **400 × 300 × 155 mm:**

Types H406 / H408 / H410 / H412:

Mtg. form	H1	B1	T1	T2	H2	B2
182M1	400	300	155	50	360	260
182N1	400	300	155	45	360	260

Gland plate at the bottom

Dimensions in mm:

Setup of order code number

Type	Switching progr.	Mtg. form
K616	41300	187H1
Order code no.	K616-41300-187H1	

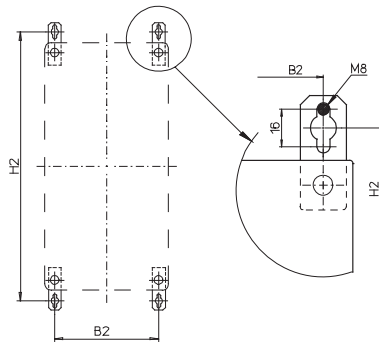
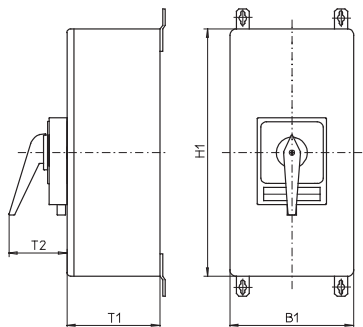

Mounting brackets are included.

Mild steel enclosure **500 × 400 × 300 mm / 600 × 400 × 300 mm / 800 × 400 × 300 mm:**

Type K616:

Mtg. form	H1	B1	T1	T2	H2	B2
187H1	500	400	300	83	545	360

Type K830:

Mtg. form	H1	B1	T1	T2	H2	B2
187H1	600	400	300	93	645	360
287H1	800	400	300	93	845	360

Further switching programmes and corresponding dimensions for types K on request.

Gland plate at the bottom



Disconnect Switches

Main Switches Enclosed Switches – Stainless Steel Enclosure

Main Switches

- Enclosed switches with stainless steel enclosure (brushed)
- Cover interlock in ON position
- 3 up to 8 pole
- 20 A up to 125 A
- IP66

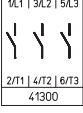
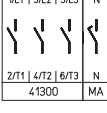

Switching programme	Rated data (IEC 60947)			Enclosure dimension (H × W × D) (mm)	Padlock device N-handle black	Padlock device M-handle black	Padlockable handle V-handle silver/black
	Operat. current I _e (A)	Operational power (at 380–440 V) (kW)			 OFF-ON	 ON-OFF	 ON-OFF
41300 – 3 pole – without auxiliary contacts 	20	5.5	3.7	150 × 150 × 120	H216-41300-097N1	H216-41300-097M1	H216-41300-097V1
	20	5.5	3.7	200 × 150 × 120	H216-41300-197N1	H216-41300-197M1	H216-41300-197V1
	25	7.5	5.5	150 × 150 × 120	H220-41300-097N1	H220-41300-097M1	H220-41300-097V1
	25	7.5	5.5	200 × 150 × 120	H220-41300-197N1	H220-41300-197M1	H220-41300-197V1
	32	11	7.5	150 × 150 × 120	H226-41300-097N1	H226-41300-097M1	H226-41300-097V1
	32	11	7.5	200 × 150 × 120	H226-41300-197N1	H226-41300-197M1	H226-41300-197V1
	40	15	11	200 × 150 × 120	H233-41300-197N1	H233-41300-197M1	H233-41300-197V1
	40	15	11	200 × 150 × 120	B240-41300-097N1*	B240-41300-097M1*	B240-41300-097V1*
	50	18.5	15	200 × 150 × 120	B250-41300-097N1	B250-41300-097M1	B250-41300-097V1
	63	22	18.5	200 × 150 × 120	B263-41300-097N1	B263-41300-097M1	B263-41300-097V1
	63	22	18.5	200 × 150 × 120	H406-41300-997N1*	H406-41300-997M1*	–
	63	22	18.5	300 × 250 × 150	H406-41300-197N1	H406-41300-197M1	–
	80	30	22	200 × 150 × 120	H408-41300-997N1	H408-41300-997M1	–
	80	30	22	300 × 250 × 150	H408-41300-197N1	H408-41300-197M1	–
	100	37	30	300 × 250 × 150	H410-41300-197N1	H410-41300-197M1	–
125	45	37	300 × 250 × 150	H412-41300-197N1	H412-41300-197M1	–	
41400 – 4 pole – without auxiliary contacts – neutral contact – early make/late break 	20	5.5	3.7	150 × 150 × 120	H216-41400-097N1	H216-41400-097M1	H216-41400-097V1
	20	5.5	3.7	200 × 150 × 120	H216-41400-197N1	H216-41400-197M1	H216-41400-197V1
	25	7.5	5.5	150 × 150 × 120	H220-41400-097N1	H220-41400-097M1	H220-41400-097V1
	25	7.5	5.5	200 × 150 × 120	H220-41400-197N1	H220-41400-197M1	H220-41400-197V1
	32	11	7.5	150 × 150 × 120	H226-41400-097N1	H226-41400-097M1	H226-41400-097V1
	32	11	7.5	200 × 150 × 120	H226-41400-197N1	H226-41400-197M1	H226-41400-197V1
	40	15	11	200 × 150 × 120	H233-41400-197N1	H233-41400-197M1	H233-41400-197V1
	40	15	11	200 × 150 × 120	B240-41400-097N1*	B240-41400-097M1*	B240-41400-097V1*
	50	18.5	15	200 × 150 × 120	B250-41400-097N1	B250-41400-097M1	B250-41400-097V1
	63	22	18.5	200 × 150 × 120	B263-41400-097N1	B263-41400-097M1	B263-41400-097V1
	63	22	18.5	200 × 150 × 120	H406-41400-997N1*	H406-41400-997M1*	–
	63	22	18.5	300 × 250 × 150	H406-41400-197N1	H406-41400-197M1	–
	80	30	22	200 × 150 × 120	H408-41400-997N1	H408-41400-997M1	–
	80	30	22	300 × 250 × 150	H408-41400-197N1	H408-41400-197M1	–
	100	37	30	300 × 250 × 150	H410-41400-197N1	H410-41400-197M1	–
125	45	37	300 × 250 × 150	H412-41400-197N1	H412-41400-197M1	–	

* larger terminal capacity, see page 154

Further switching programmes from page 132.

Switching programme	Rated data (IEC 60947)			Enclosure dimension (H × W × D) (mm)	Padlock device N-handle black	Padlock device M-handle black	Padlockable handle V-handle silver/black
	Operat. current I _e	Operational power (at 380–440 V)			IP66	IP66	IP66
	AC-21A (A)	AC-23A (kW)	AC-3 (kW)		Order code number	Order code number	Order code number
41600 – 6 pole – without auxiliary contacts 	20	5.5	3.7	200 × 150 × 120	H216-41600-197N1	H216-41600-197M1	H216-41600-197V1
	25	7.5	5.5	200 × 150 × 120	H220-41600-197N1	H220-41600-197M1	H220-41600-197V1
	32	11	7.5	200 × 150 × 120	H226-41600-197N1	H226-41600-197M1	H226-41600-197V1
	40	15	11	200 × 150 × 120	H233-41600-197N1	H233-41600-197M1	H233-41600-197V1
	40	15	11	300 × 250 × 150	B240-41600-197N1	B240-41600-197M1	–
	50	18.5	15	300 × 250 × 150	B250-41600-197N1	B250-41600-197M1	–
	63	22	18.5	300 × 250 × 150	B263-41600-197N1	B263-41600-197M1	–
	63	22	18.5	300 × 250 × 150	H406-41600-197N1*	H406-41600-197M1*	–
	80	30	22	300 × 250 × 150	H408-41600-197N1	H408-41600-197M1	–
	100	37	30	300 × 250 × 150	H410-41600-197N1	H410-41600-197M1	–
125	45	37	300 × 250 × 150	H412-41600-197N1	H412-41600-197M1	–	
41800 – 8 pole – without auxiliary contacts – 2 neutral contacts early make/late break 	20	5.5	3.7	200 × 150 × 120	H216-41800-197N1	H216-41800-197M1	H216-41800-197V1
	25	7.5	5.5	200 × 150 × 120	H220-41800-197N1	H220-41800-197M1	H220-41800-197V1
	32	11	7.5	200 × 150 × 120	H226-41800-197N1	H226-41800-197M1	H226-41800-197V1
	40	15	11	200 × 150 × 120	H233-41800-197N1	H233-41800-197M1	H233-41800-197V1
	40	15	11	300 × 250 × 150	B240-41800-197N1	B240-41800-197M1	–
	50	18.5	15	300 × 250 × 150	B250-41800-197N1	B250-41800-197M1	–
	63	22	18.5	300 × 250 × 150	B263-41800-197N1	B263-41800-197M1	–
	63	22	18.5	300 × 250 × 150	H406-41800-197N1*	H406-41800-197M1*	–
	80	30	22	300 × 250 × 150	H408-41800-197N1	H408-41800-197M1	–
	100	37	30	300 × 250 × 150	H410-41800-197N1	H410-41800-197M1	–
125	45	37	300 × 250 × 150	H412-41800-197N1	H412-41800-197M1	–	

* larger terminal capacity, see page 154

Further switching programmes from page 132.

Dimensions in mm:

Setup of order code number		
Type	Switching progr.	Mtg. form
B263	41800	197V1
Order code no.	B263-41800-197V1	

Types H216 / H220 / H226 / H233:

Mtg. form	H1	B1	T1	T2	H2	B2
097M1	150	150	120	38	132	85
097N1	150	150	120	33	132	85
097V1	150	150	120	39	132	85
197M1	200	150	120	38	182	85
197N1	200	150	120	33	182	85
197V1	200	150	120	39	182	85

Types B240 / B250 / B263:

Mtg. form	H1	B1	T1	T2	H2	B2
097M1	200	150	120	38	182	85
097N1	200	150	120	33	182	85
097V1	200	150	120	39	182	85
197M1	300	250	150	50	282	185
197N1	300	250	150	45	282	185

Types H406 / H408 / H410 / H412:

Mtg. form	H1	B1	T1	T2	H2	B2
197M1	300	250	150	50	282	185
197N1	300	250	150	45	282	185
997M1	200	150	120	50	182	85
997N1	200	150	120	45	182	85

Please order mounting brackets separately, see page 148.

Disconnect Switches

ON-OFF Switches Front mounting Four hole mounting

ON-OFF Switches

- Front mounting switches with four hole mounting
- 3 up to 8 pole
- 20 A up to 315 A
- IP66 / IP55



Switching programme	Rated data (IEC 60947)			Mounting dimension (mm)	M-handle silver/black	G-handle silver/black
	Operat. current I _e	Operational power (at 380–440 V)			IP66	IP55
	AC-21A (A)	AC-23A (kW)	AC-3 (kW)		Order code number	Order code number
41300 – 3 pole – without auxiliary contacts 	20	5.5	3.7	36 × 36	H216-41300-003M1	–
	20	5.5	3.7	48 × 48	H216-41300-013M1	–
	25	7.5	5.5	36 × 36	H220-41300-003M1	–
	25	7.5	5.5	48 × 48	H220-41300-013M1	–
	32	11	7.5	36 × 36	H226-41300-003M1	–
	32	11	7.5	48 × 48	H226-41300-013M1	–
	40	15	11	36 × 36	H233-41300-003M1	–
	40	15	11	36 × 36	B240-41300-003M1*	–
	40	15	11	48 × 48	H233-41300-013M1	–
	40	15	11	48 × 48	B240-41300-013M1*	–
	50	18.5	15	36 × 36	B250-41300-003M1	–
	50	18.5	15	48 × 48	B250-41300-013M1	–
	63	22	18.5	36 × 36	B263-41300-003M1	–
	63	22	18.5	48 × 48	B263-41300-013M1	–
	63	22	18.5	48 × 48	H406-41300-003M1*	–
	63	22	18.5	68 × 68	H406-41300-013M1	–
	80	30	22	48 × 48	H408-41300-003M1	–
	80	30	22	68 × 68	H408-41300-013M1	–
	100	37	30	48 × 48	H410-41300-003M1	–
	100	37	30	68 × 68	H410-41300-013M1	–
125	45	37	48 × 48	H412-41300-003M1	–	
125	45	37	68 × 68	H412-41300-013M1	–	
160	75	45	68 × 68	–	K616-41300-003G1	
160	75	45	104 × 104	–	K616-41300-013G1	
315	132	55	104 × 104	–	K830-41300-003G1	

* larger terminal capacity, see page 154

Further switching programmes from page 132.

Disconnect Switches



ON-OFF Switches Front mounting Four hole mounting

Switching programme	Rated data (IEC 60947)			Mounting dimension (mm)	M-handle silver/black	G-handle silver/black	
	Operat. current I_e	Operational power (at 380–440 V)			IP66	IP55	
	AC-21A (A)	AC-23A (kW)	AC-3 (kW)		Order code number	Order code number	
41400 – 4 pole – without auxiliary contacts – neutral contact – early make/late break 	20	5.5	3.7	36 × 36	H216-41400-003M1	–	
	20	5.5	3.7	48 × 48	H216-41400-013M1	–	
	25	7.5	5.5	36 × 36	H220-41400-003M1	–	
	25	7.5	5.5	48 × 48	H220-41400-013M1	–	
	32	11	7.5	36 × 36	H226-41400-003M1	–	
	32	11	7.5	48 × 48	H226-41400-013M1	–	
	40	15	11	36 × 36	H233-41400-003M1	–	
	40	15	11	36 × 36	B240-41400-003M1*	–	
	40	15	11	48 × 48	H233-41400-013M1	–	
	40	15	11	48 × 48	B240-41400-013M1*	–	
	50	18.5	15	36 × 36	B250-41400-003M1	–	
	50	18.5	15	48 × 48	B250-41400-013M1	–	
	63	22	18.5	36 × 36	B263-41400-003M1	–	
	63	22	18.5	48 × 48	B263-41400-013M1	–	
	63	22	18.5	48 × 48	H406-41400-003M1*	–	
	63	22	18.5	68 × 68	H406-41400-013M1	–	
	80	30	22	48 × 48	H408-41400-003M1	–	
	80	30	22	68 × 68	H408-41400-013M1	–	
	100	37	30	48 × 48	H410-41400-003M1	–	
	100	37	30	68 × 68	H410-41400-013M1	–	
	125	45	37	48 × 48	H412-41400-003M1	–	
125	45	37	68 × 68	H412-41400-013M1	–		
160	75	45	68 × 68	–	K616-41400-003G1		
160	75	45	104 × 104	–	K616-41400-013G1		
315	132	55	104 × 104	–	K830-41400-003G1		

* larger terminal capacity, see page 154

Further switching programmes from page 132.

Disconnect Switches

ON-OFF Switches Front mounting Four hole mounting

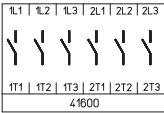
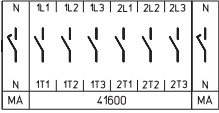
Switching programme	Rated data (IEC 60947)			Mounting dimension (mm)	M-handle silver/black	G-handle silver/black	
	Operat. current I_e	Operational power (at 380–440 V)			IP66	IP55	
	AC-21A (A)	AC-23A (kW)	AC-3 (kW)		Order code number	Order code number	
41600 – 6 pole – without auxiliary contacts 	20	5.5	3.7	48 × 48	H216-41600-013M1	–	
	25	7.5	5.5	48 × 48	H220-41600-013M1	–	
	32	11	7.5	48 × 48	H226-41600-013M1	–	
	40	15	11	48 × 48	H233-41600-013M1	–	
	40	15	11	48 × 48	B240-41600-013M1*	–	
	50	18.5	15	48 × 48	B250-41600-013M1	–	
	63	22	18.5	48 × 48	B263-41600-013M1	–	
	63	22	18.5	48 × 48	H406-41600-003M1*	–	
	63	22	18.5	68 × 68	H406-41600-013M1	–	
	80	30	22	48 × 48	H408-41600-003M1	–	
	80	30	22	68 × 68	H408-41600-013M1	–	
	100	37	30	48 × 48	H410-41600-003M1	–	
	100	37	30	68 × 68	H410-41600-013M1	–	
	125	45	37	48 × 48	H412-41600-003M1	–	
	125	45	37	68 × 68	H412-41600-013M1	–	
	160	75	45	68 × 68	–	K616-41600-003G1	
	160	75	45	104 × 104	–	K616-41600-013G1	
	315	132	55	104 × 104	–	K830-41600-003G1	
41800 – 8 pole – without auxiliary contacts – 2 neutral contacts early make/late break 	20	5.5	3.7	48 × 48	H216-41800-013M1	–	
	25	7.5	5.5	48 × 48	H220-41800-013M1	–	
	32	11	7.5	48 × 48	H226-41800-013M1	–	
	40	15	11	48 × 48	H233-41800-013M1	–	
	40	15	11	48 × 48	B240-41800-013M1*	–	
	50	18.5	15	48 × 48	B250-41800-013M1	–	
	63	22	18.5	48 × 48	B263-41800-013M1	–	
	63	22	18.5	48 × 48	H406-41800-003M1*	–	
	63	22	18.5	68 × 68	H406-41800-013M1	–	
	80	30	22	48 × 48	H408-41800-003M1	–	
	80	30	22	68 × 68	H408-41800-013M1	–	
	100	37	30	48 × 48	H410-41800-003M1	–	
	100	37	30	68 × 68	H410-41800-013M1	–	
	125	45	37	48 × 48	H412-41800-003M1	–	
	125	45	37	68 × 68	H412-41800-013M1	–	
	160	75	45	68 × 68	–	K616-41800-003G1	
	160	75	45	104 × 104	–	K616-41800-013G1	
	315	132	55	104 × 104	–	K830-41800-003G1	

* larger terminal capacity, see page 154

Further switching programmes from page 132.

Dimensions in mm:

Setup of order code number

Type	Switching progr.	Mtg. form
H406	41800	013M1
Order code no.	H406-41800-013M1	

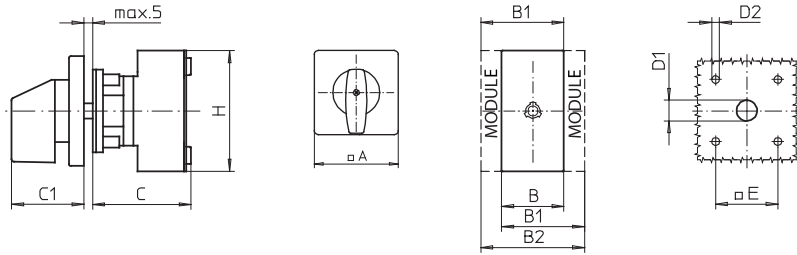

Switching programmes 3 and 4 pole

Types H216 / H220 / H226 / H233:

Mtg. form	A	B	B1	B2	C	C1	D1	D2	E	H
003M1	48	36	48	60	58	32	12	4.5	36	70
013M1	64	36	48	60	58	39	15	5	48	70

Types B240 / B250 / B263:

Mtg. form	A	B	B1	B2	C	C1	D1	D2	E	H
003M1	48	50	69	88	58	32	12	4.5	36	72
013M1	64	50	69	88	58	39	15	5	48	72

Types H406 / H408 / H410 / H412:

Mtg. form	A	B	B1	B2	C	C1	D1	D2	E	H
003M1	64	70	89	108	73	39	15	5	48	80
013M1	88	70	89	108	73	52	15	5.5	68	80

Switching programmes 6 and 8 pole

Types H216 / H220 / H226 / H233:

Mtg. form	A	B	B1	B2	C	C1	D1	D2	E	H
013M1	64	72	84	96	66	39	15	5	48	70

Types B240 / B250 / B263:

Mtg. form	A	B	B1	B2	C	C1	D1	D2	E	H
013M1	64	100	119	138	70	39	15	5	48	72

Types H406 / H408 / H410 / H412:

Mtg. form	A	B	B1	B2	C	C1	D1	D2	E	H
003M1	64	140	159	178	86	39	15	5	48	80
013M1	88	140	159	178	86	52	15	5.5	68	80

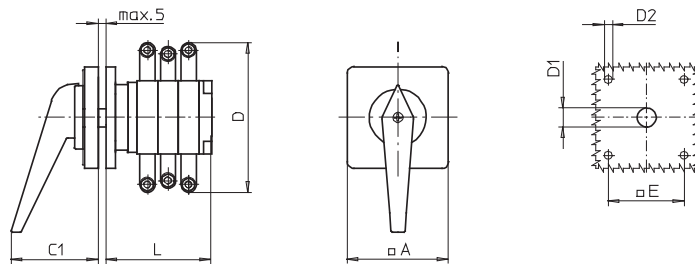

Type K616:

Mtg. form	Switching progr.	A	C1	D*	D1	D2	E	L
003G1	41300	88	66	150	20	5.5	68	104
003G1	41400	88	66	150	20	5.5	68	104
013G1	41300	130	74	150	20	5.5	104	104
013G1	41400	130	74	150	20	5.5	104	104

Type K830:

Mtg. form	Switching progr.	A	C1	D*	D1	D2	E	L
003G1	41300	130	74	210	20	5.5	104	125
003G1	41400	130	74	210	20	5.5	104	125

Type K616:

Mtg. form	Switching progr.	A	C1	D*	D1	D2	E	L
003G1	41600	88	66	150	20	5.5	68	136
003G1	41800	88	66	150	20	5.5	68	168
013G1	41600	130	74	150	20	5.5	104	136
013G1	41800	130	74	150	20	5.5	104	168

Type K830:

Mtg. form	Switching progr.	A	C1	D*	D1	D2	E	L
003G1	41600	130	74	210	20	5.5	104	161
003G1	41800	130	74	210	20	5.5	104	197

Further switching programmes and corresponding dimensions for types K on request.

* terminal lugs included

Disconnect Switches

ON-OFF Switches Front mounting Single hole mounting

ON-OFF Switches

- Front mounting switches with single hole mounting
- 3 up to 4 pole
- 20 A up to 63 A
- IP66



Switching programme	Rated data (IEC 60947)			Mounting dimension (mm)	M-handle silver/black	M-handle with front ring black/black
	Operat. current I_e	Operational power (at 380–440 V)			IP66	IP66
	AC-21A (A)	AC-23A (kW)	AC-3 (kW)		Order code number	Order code number
41300 – 3 pole – without auxiliary contacts 	20	5.5	3.7	∅ 22.5	H216-41300-219M1	H216-41300-218M1
	20	5.5	3.7	∅ 30.5	H216-41300-209M1	H216-41300-208M1
	25	7.5	5.5	∅ 22.5	H220-41300-219M1	H220-41300-218M1
	25	7.5	5.5	∅ 30.5	H220-41300-209M1	H220-41300-208M1
	32	11	7.5	∅ 22.5	H226-41300-219M1	H226-41300-218M1
	32	11	7.5	∅ 30.5	H226-41300-209M1	H226-41300-208M1
	40	15	11	∅ 22.5	H233-41300-219M1	H233-41300-218M1
	40	15	11	∅ 22.5	B240-41300-219M1*	B240-41300-218M1*
	40	15	11	∅ 30.5	H233-41300-209M1	H233-41300-208M1
	40	15	11	∅ 30.5	B240-41300-209M1*	B240-41300-208M1*
	50	18.5	15	∅ 22.5	B250-41300-219M1	B250-41300-218M1
	50	18.5	15	∅ 30.5	B250-41300-209M1	B250-41300-208M1
	63	22	18.5	∅ 22.5	B263-41300-219M1	B263-41300-218M1
	63	22	18.5	∅ 30.5	B263-41300-209M1	B263-41300-208M1

41400 – 4 pole – without auxiliary contacts – neutral contact – early make/late break 	20	5.5	3.7	∅ 22.5	H216-41400-219M1	H216-41400-218M1
	20	5.5	3.7	∅ 30.5	H216-41400-209M1	H216-41400-208M1
	25	7.5	5.5	∅ 22.5	H220-41400-219M1	H220-41400-218M1
	25	7.5	5.5	∅ 30.5	H220-41400-209M1	H220-41400-208M1
	32	11	7.5	∅ 22.5	H226-41400-219M1	H226-41400-218M1
	32	11	7.5	∅ 30.5	H226-41400-209M1	H226-41400-208M1
	40	15	11	∅ 22.5	H233-41400-219M1	H233-41400-218M1
	40	15	11	∅ 22.5	B240-41400-219M1*	B240-41400-218M1*
	40	15	11	∅ 30.5	H233-41400-209M1	H233-41400-208M1
	40	15	11	∅ 30.5	B240-41400-209M1*	B240-41400-208M1*
	50	18.5	15	∅ 22.5	B250-41400-219M1	B250-41400-218M1
	50	18.5	15	∅ 30.5	B250-41400-209M1	B250-41400-208M1
	63	22	18.5	∅ 22.5	B263-41400-219M1	B263-41400-218M1
	63	22	18.5	∅ 30.5	B263-41400-209M1	B263-41400-208M1

* larger terminal capacity, see page 154

Further switching programmes from page 132.

Dimensions in mm:

Setup of order code number

Type	Switching progr.	Mtg. form
H226	41300	219M1
Order code no. H226-41300-219M1		

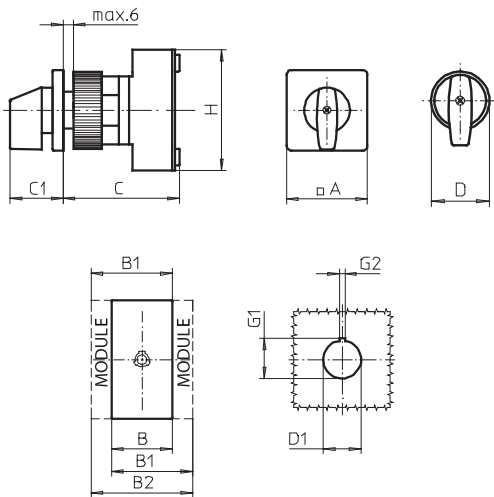

Types H216 / H220 / H226 / H233:

Mtg. form	A	B	B1	B2	C	C1	D	D1	G1	G2	H
208M1	-	36	48	60	75	32	39.5	30.5	33	4.8	70
209M1	48	36	48	60	75	32	-	30.5	33	4.8	70
218M1	-	36	48	60	75	31.5	31	22.5	24.2	3.2	70
219M1	48	36	48	60	75	32	-	22.5	24.2	3.2	70

Types B240 / B250 / B263:

Mtg. form	A	B	B1	B2	C	C1	D	D1	G1	G2	H
208M1	-	50	69	88	75	32	39.5	30.5	33	4.8	72
209M1	48	50	69	88	75	32	-	30.5	33	4.8	72
218M1	-	50	69	88	75	31.5	31	22.5	24.2	3.2	72
219M1	48	50	69	88	75	32	-	22.5	24.2	3.2	72







Disconnect Switches

ON-OFF Switches **Base mounting** Snap-on mounting for DIN rail

ON-OFF Switches

- Base mounting switches with snap-on mounting
- for DIN rail
- 3 up to 8 pole
- 20 A up to 125 A
- IP30

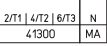

Switching programme	Rated data (IEC 60947)			Escutcheon dimension for 45 mm aperture in Panel/Distribution boards (H × W) (mm)	M-handle silver/black	N-handle silver/grey
	Operat. current I _e	Operational power (at 380–440 V)			  IP30	  IP30
	AC-21A (A)	AC-23A (kW)	AC-3 (kW)		Order code number	Order code number
41300 – 3 pole – without auxiliary contacts   41300	20	5.5	3.7	45 × 48	H216-41300-026M1	H216-41300-026N2
	20	5.5	3.7	45 × 60	H216-41300-126M1	–
	25	7.5	5.5	45 × 48	H220-41300-026M1	H220-41300-026N2
	25	7.5	5.5	45 × 60	H220-41300-126M1	–
	32	11	7.5	45 × 48	H226-41300-026M1	H226-41300-026N2
	32	11	7.5	45 × 60	H226-41300-126M1	–
	40	15	11	45 × 48	H233-41300-026M1	H233-41300-026N2
	40	15	11	45 × 60	H233-41300-126M1	–
	40	15	11	45 × 52.5	B240-41300-026M1*	B240-41300-026N2*
	50	18.5	15	45 × 52.5	B250-41300-026M1	B250-41300-026N2
	63	22	18.5	45 × 52.5	B263-41300-026M1	B263-41300-026N2
	63	22	18.5	45 × 72	H406-41300-126M1*	–
	80	30	22	45 × 72	H408-41300-126M1	–
	100	37	30	45 × 72	H410-41300-126M1	–
125	45	37	45 × 72	H412-41300-126M1	–	
41400 – 4 pole – without auxiliary contacts – neutral contact early make/late break   41400 MA	20	5.5	3.7	45 × 48	H216-41400-026M1	H216-41400-026N2
	20	5.5	3.7	45 × 60	H216-41400-126M1	–
	25	7.5	5.5	45 × 48	H220-41400-026M1	H220-41400-026N2
	25	7.5	5.5	45 × 60	H220-41400-126M1	–
	32	11	7.5	45 × 48	H226-41400-026M1	H226-41400-026N2
	32	11	7.5	45 × 60	H226-41400-126M1	–
	40	15	11	45 × 48	H233-41400-026M1	H233-41400-026N2
	40	15	11	45 × 60	H233-41400-126M1	–
	40	15	11	45 × 52.5	B240-41400-026M1*	B240-41400-026N2*
	50	18.5	15	45 × 52.5	B250-41400-026M1	B250-41400-026N2
	63	22	18.5	45 × 52.5	B263-41400-026M1	B263-41400-026N2
	63	22	18.5	45 × 72	H406-41400-126M1*	–
	80	30	22	45 × 72	H408-41400-126M1	–
	100	37	30	45 × 72	H410-41400-126M1	–
125	45	37	45 × 72	H412-41400-126M1	–	

* larger terminal capacity, see page 154

Further switching programmes from page 132.

Switching programme	Rated data (IEC 60947)			Escutcheon dimension for 45 mm aperture in Panel/Distribution boards (H × W) (mm)	M-handle silver/black IP30	Order code number
	Operat. current I _e	Operational power (at 380–440 V)				
	AC-21A (A)	AC-23A (kW)	AC-3 (kW)			
41600 – 6 pole – without auxiliary contacts 	20	5.5	3.7	45 × 76	H216-41600-026M1	
	25	7.5	5.5	45 × 76	H220-41600-026M1	
	32	11	7.5	45 × 76	H226-41600-026M1	
	40	15	11	45 × 76	H233-41600-026M1	
	40	15	11	45 × 105	B240-41600-026M1*	
	50	18.5	15	45 × 105	B250-41600-026M1	
	63	22	18.5	45 × 105	B263-41600-026M1	
	63	22	18.5	45 × 72	H406-41600-126M1*	
	80	30	22	45 × 72	H408-41600-126M1	
	100	37	30	45 × 72	H410-41600-126M1	
	125	45	37	45 × 72	H412-41600-126M1	
41800 – 8 pole – without auxiliary contacts – 2 neutral contacts early make/late break 	20	5.5	3.7	45 × 76	H216-41800-026M1	
	25	7.5	5.5	45 × 76	H220-41800-026M1	
	32	11	7.5	45 × 76	H226-41800-026M1	
	40	15	11	45 × 76	H233-41800-026M1	
	40	15	11	45 × 105	B240-41800-026M1*	
	50	18.5	15	45 × 105	B250-41800-026M1	
	63	22	18.5	45 × 105	B263-41800-026M1	
	63	22	18.5	45 × 72	H406-41800-126M1*	
	80	30	22	45 × 72	H408-41800-126M1	
	100	37	30	45 × 72	H410-41800-126M1	
	125	45	37	45 × 72	H412-41800-126M1	

* larger terminal capacity, see page 154

Further switching programmes from page 132.

Dimensions in mm:

Setup of order code number		
Type	Switching progr.	Mtg. form
H220	41400	026M1
Order code no.	H220-41400-026M1	

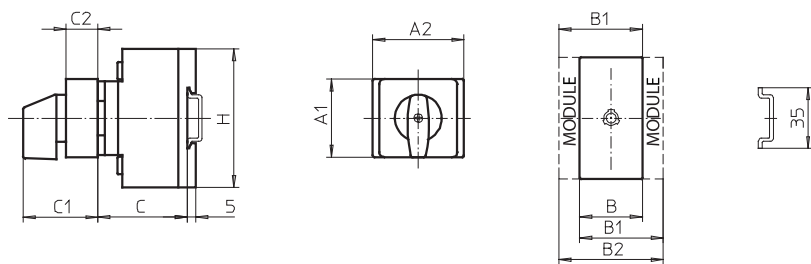

Switching programmes 3 and 4 pole

Types H216 / H220 / H226 / H233:

Mtg. form	A1	A2	B	B1	B2	C	C1	C2	H
026M1	45	48	36	48	60	38	45	18.5	70
026N2	45	48	36	48	60	38	40	18.5	70
126M1	45	60	36	48	60	38	45	18.5	70

Types B240 / B250 / B263:

Mtg. form	A1	A2	B	B1	B2	C	C1	C2	H
026M1	45	52.5	50	69	88	38	45	18.5	72
026N2	45	52.5	50	69	88	38	40	18.5	72

Types H406 / H408 / H410 / H412:

Mtg. form	A1	A2	B	B1	B2	C	C1	C2	H
126M1	45	72	70	89	108	55	48	16	80

Switching programmes 6 and 8 pole

Types H216 / H220 / H226 / H233:

Mtg. form	A1	A2	B	B1	B2	C	C1	C2	H
026M1	45	76	72	84	96	40	51.5	25.5	70

Types B240 / B250 / B263:

Mtg. form	A1	A2	B	B1	B2	C	C1	C2	H
026M1	45	105	100	119	138	40	51.5	25.5	72

Types H406 / H408 / H410 / H412:

Mtg. form	A1	A2	B	B1	B2	C	C1	C2	H
126M1	45	72	140	159	178	67	48	16	80

Disconnect Switches

ON-OFF Switches **Base mounting** Snap-on mounting with door interlock

ON-OFF Switches

- Base mounting switches with snap-on mounting
- Door interlock
- 3 up to 8 pole
- 20 A up to 125 A
- **IP66**
- with modular or metal shaft extension
- single or four hole front mounting



Base mounting switches with snap-on mounting and door interlock are offered with two different extensions:

1. Switches with **modular shaft extensions** can be extended with additional modules (modular shaft extensions see picture) which can be fixed to achieve different required mounting depths – dimension C. The modules are detailed on page 145.

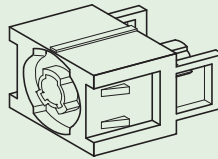
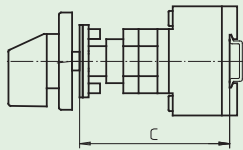

AVC2/AVC4
Modular shaft extension

2. For switches with **metal shaft extension** the metal shaft is not included in the scope of delivery and has to be ordered separately. Data for mounting dimension C and for the different types of metal shafts can be found on page 146.

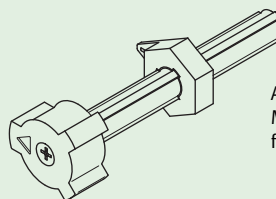
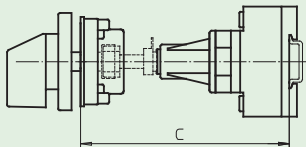

AVB8
Metal shaft extension for
four hole front mounting

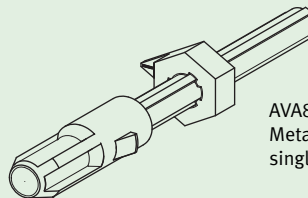
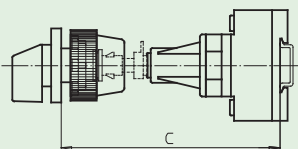

AVA8
Metal shaft extension for
single hole front mounting

Switching programme	Rated data (IEC 60947)			Mounting dimension (front) (mm)	M-handle silver/black
	Operat. current I_e	Operational power (at 380–440 V)			
	AC-21A (A)	AC-23A (kW)	AC-3 (kW)		Order code number

41300
– 3 pole
– without auxiliary contacts

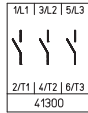

Modular shaft extension:

➔ Modular shaft extensions see page 145!

20	5.5	3.7	36 x 36	H216-41300-242M1	
20	5.5	3.7	48 x 48	H216-41300-248M1	
25	7.5	5.5	36 x 36	H220-41300-242M1	
25	7.5	5.5	48 x 48	H220-41300-248M1	
32	11	7.5	36 x 36	H226-41300-242M1	
32	11	7.5	48 x 48	H226-41300-248M1	
40	15	11	36 x 36	H233-41300-242M1	
40	15	11	36 x 36	B240-41300-242M1*	
40	15	11	48 x 48	H233-41300-248M1	
40	15	11	48 x 48	B240-41300-248M1*	
50	18.5	15	36 x 36	B250-41300-242M1	
50	18.5	15	48 x 48	B250-41300-248M1	
63	22	18.5	36 x 36	B263-41300-242M1	
63	22	18.5	48 x 48	B263-41300-248M1	
63	22	18.5	48 x 48	H406-41300-242M1*	
80	30	22	48 x 48	H408-41300-242M1	
100	37	30	48 x 48	H410-41300-242M1	
125	45	37	48 x 48	H412-41300-242M1	

Metal shaft extension:

➔ Metal shaft is not included. Please order separately, see page 146!

20	5.5	3.7	36 x 36	H216-41300-481M1	
20	5.5	3.7	48 x 48	H216-41300-482M1	
20	5.5	3.7	Ø 22.5	H216-41300-283M1	
25	7.5	5.5	36 x 36	H220-41300-481M1	
25	7.5	5.5	48 x 48	H220-41300-482M1	
25	7.5	5.5	Ø 22.5	H220-41300-283M1	
32	11	7.5	36 x 36	H226-41300-481M1	
32	11	7.5	48 x 48	H226-41300-482M1	
32	11	7.5	Ø 22.5	H226-41300-283M1	
40	15	11	36 x 36	H233-41300-481M1	
40	15	11	36 x 36	B240-41300-481M1*	
40	15	11	48 x 48	H233-41300-482M1	
40	15	11	48 x 48	B240-41300-482M1*	
40	15	11	Ø 22.5	H233-41300-283M1	
40	15	11	Ø 22.5	B240-41300-283M1*	
50	18.5	15	36 x 36	B250-41300-481M1	
50	18.5	15	48 x 48	B250-41300-482M1	
50	18.5	15	Ø 22.5	B250-41300-283M1	
63	22	18.5	36 x 36	B263-41300-481M1	
63	22	18.5	48 x 48	B263-41300-482M1	
63	22	18.5	48 x 48	H406-41300-481M1*	
63	22	18.5	Ø 22.5	B263-41300-283M1	
63	22	18.5	Ø 22.5	H406-41300-283M1*	
80	30	22	48 x 48	H408-41300-481M1	
80	30	22	Ø 22.5	H408-41300-283M1	
100	37	30	48 x 48	H410-41300-481M1	
100	37	30	Ø 22.5	H410-41300-283M1	
125	45	37	48 x 48	H412-41300-481M1	
125	45	37	Ø 22.5	H412-41300-283M1	

* larger terminal capacity, see page 154

Further switching programmes from page 132.

Disconnect Switches

ON-OFF Switches **Base mounting** Snap-on mounting with door interlock

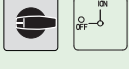
Switching programme	Rated data (IEC 60947)			Mounting dimension (front) (mm)	M-handle silver/black
	Operat. current I_e	Operational power (at 380–440 V)			
	AC-21A (A)	AC-23A (kW)	AC-3 (kW)		Order code number

41400

- 4 pole
- without auxiliary contacts
- neutral contact
- early make/late break

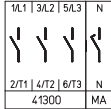

Modular shaft extension:

→ Modular shaft extensions see page 145!

20	5.5	3.7	36 x 36	H216-41400-242M1	
20	5.5	3.7	48 x 48	H216-41400-248M1	
25	7.5	5.5	36 x 36	H220-41400-242M1	
25	7.5	5.5	48 x 48	H220-41400-248M1	
32	11	7.5	36 x 36	H226-41400-242M1	
32	11	7.5	48 x 48	H226-41400-248M1	
40	15	11	36 x 36	H233-41400-242M1	
40	15	11	36 x 36	B240-41400-242M1*	
40	15	11	48 x 48	H233-41400-248M1	
40	15	11	48 x 48	B240-41400-248M1*	
50	18.5	15	36 x 36	B250-41400-242M1	
50	18.5	15	48 x 48	B250-41400-248M1	
63	22	18.5	36 x 36	B263-41400-242M1	
63	22	18.5	48 x 48	B263-41400-248M1	
63	22	18.5	48 x 48	H406-41400-242M1*	
80	30	22	48 x 48	H408-41400-242M1	
100	37	30	48 x 48	H410-41400-242M1	
125	45	37	48 x 48	H412-41400-242M1	

Metal shaft extension:

→ Metal shaft is not included. Please order separately, see page 146!

20	5.5	3.7	36 x 36	H216-41400-481M1	
20	5.5	3.7	48 x 48	H216-41400-482M1	
20	5.5	3.7	∅ 22.5	H216-41400-283M1	
25	7.5	5.5	36 x 36	H220-41400-481M1	
25	7.5	5.5	48 x 48	H220-41400-482M1	
25	7.5	5.5	∅ 22.5	H220-41400-283M1	
32	11	7.5	36 x 36	H226-41400-481M1	
32	11	7.5	48 x 48	H226-41400-482M1	
32	11	7.5	∅ 22.5	H226-41400-283M1	
40	15	11	36 x 36	H233-41400-481M1	
40	15	11	36 x 36	B240-41400-481M1*	
40	15	11	48 x 48	H233-41400-482M1	
40	15	11	48 x 48	B240-41400-482M1*	
40	15	11	∅ 22.5	H233-41400-283M1	
40	15	11	∅ 22.5	B240-41400-283M1*	
50	18.5	15	36 x 36	B250-41400-481M1	
50	18.5	15	48 x 48	B250-41400-482M1	
50	18.5	15	∅ 22.5	B250-41400-283M1	
63	22	18.5	36 x 36	B263-41400-481M1	
63	22	18.5	48 x 48	B263-41400-482M1	
63	22	18.5	48 x 48	H406-41400-481M1*	
63	22	18.5	∅ 22.5	B263-41400-283M1	
63	22	18.5	∅ 22.5	H406-41400-283M1*	
80	30	22	48 x 48	H408-41400-481M1	
80	30	22	∅ 22.5	H408-41400-283M1	
100	37	30	48 x 48	H410-41400-481M1	
100	37	30	∅ 22.5	H410-41400-283M1	
125	45	37	48 x 48	H412-41400-481M1	
125	45	37	∅ 22.5	H412-41400-283M1	

* larger terminal capacity, see page 154

Further switching programmes from page 132.

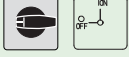
Switching programme	Rated data (IEC 60947)			Mounting dimension (front) (mm)	M-handle silver/black
	Operat. current I_e	Operational power (at 380–440 V)			 IP66
	AC-21A (A)	AC-23A (kW)	AC-3 (kW)		Order code number

41600

- 6 pole
- without auxiliary contacts

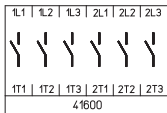

Modular shaft extension:

➔ Modular shaft extensions see page 145!

20	5.5	3.7	48 x 48	H216-41600-248M1	
25	7.5	5.5	48 x 48	H220-41600-248M1	
32	11	7.5	48 x 48	H226-41600-248M1	
40	15	11	48 x 48	H233-41600-248M1	
40	15	11	48 x 48	B240-41600-248M1*	
50	18.5	15	48 x 48	B250-41600-248M1	
63	22	18.5	48 x 48	B263-41600-248M1	
63	22	18.5	48 x 48	H406-41600-242M1*	
80	30	22	48 x 48	H408-41600-242M1	
100	37	30	48 x 48	H410-41600-242M1	
125	45	37	48 x 48	H412-41600-242M1	

Metal shaft extension:

➔ Metal shaft is not included. Please order separately, see page 146!

20	5.5	3.7	48 x 48	H216-41600-482M1	
20	5.5	3.7	∅ 22.5	H216-41600-285M1	
25	7.5	5.5	48 x 48	H220-41600-482M1	
25	7.5	5.5	∅ 22.5	H220-41600-285M1	
32	11	7.5	48 x 48	H226-41600-482M1	
32	11	7.5	∅ 22.5	H226-41600-285M1	
40	15	11	48 x 48	H233-41600-482M1	
40	15	11	48 x 48	B240-41600-482M1*	
40	15	11	∅ 22.5	H233-41600-285M1	
40	15	11	∅ 22.5	B240-41600-285M1*	
50	18.5	15	48 x 48	B250-41600-482M1	
50	18.5	15	∅ 22.5	B250-41600-285M1	
63	22	18.5	48 x 48	B263-41600-482M1	
63	22	18.5	48 x 48	H406-41600-481M1*	
63	22	18.5	∅ 22.5	B263-41600-285M1	
63	22	18.5	∅ 22.5	H406-41600-283M1*	
80	30	22	48 x 48	H408-41600-481M1	
80	30	22	∅ 22.5	H408-41600-283M1	
100	37	30	48 x 48	H410-41600-481M1	
100	37	30	∅ 22.5	H410-41600-283M1	
125	45	37	48 x 48	H412-41600-481M1	
125	45	37	∅ 22.5	H412-41600-283M1	

* larger terminal capacity, see page 154

Further switching programmes from page 132.

Disconnect Switches

ON-OFF Switches **Base mounting** Snap-on mounting with door interlock

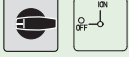
Switching programme	Rated data (IEC 60947)			Mounting dimension (front) (mm)	M-handle silver/black
	Operat. current I_e	Operational power (at 380–440 V)			 IP66
	AC-21A (A)	AC-23A (kW)	AC-3 (kW)		Order code number

41800

- 8 pole
- without auxiliary contacts
- 2 neutral contacts early make/late break

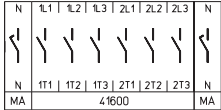

Modular shaft extension:

➔ Modular shaft extensions see page 145!

20	5.5	3.7	48 x 48	H216-41800-248M1	
25	7.5	5.5	48 x 48	H220-41800-248M1	
32	11	7.5	48 x 48	H226-41800-248M1	
40	15	11	48 x 48	H233-41800-248M1	
40	15	11	48 x 48	B240-41800-248M1*	
50	18.5	15	48 x 48	B250-41800-248M1	
63	22	18.5	48 x 48	B263-41800-248M1	
63	22	18.5	48 x 48	H406-41800-242M1*	
80	30	22	48 x 48	H408-41800-242M1	
100	37	30	48 x 48	H410-41800-242M1	
125	45	37	48 x 48	H412-41800-242M1	

Metal shaft extension:

➔ Metal shaft is not included. Please order separately, see page 146!

20	5.5	3.7	48 x 48	H216-41800-482M1	
20	5.5	3.7	∅ 22.5	H216-41800-285M1	
25	7.5	5.5	48 x 48	H220-41800-482M1	
25	7.5	5.5	∅ 22.5	H220-41800-285M1	
32	11	7.5	48 x 48	H226-41800-482M1	
32	11	7.5	∅ 22.5	H226-41800-285M1	
40	15	11	48 x 48	H233-41800-482M1	
40	15	11	48 x 48	B240-41800-482M1*	
40	15	11	∅ 22.5	H233-41800-285M1	
40	15	11	∅ 22.5	B240-41800-285M1*	
50	18.5	15	48 x 48	B250-41800-482M1	
50	18.5	15	∅ 22.5	B250-41800-285M1	
63	22	18.5	48 x 48	B263-41800-482M1	
63	22	18.5	48 x 48	H406-41800-481M1*	
63	22	18.5	∅ 22.5	B263-41800-285M1	
63	22	18.5	∅ 22.5	H406-41800-283M1*	
80	30	22	48 x 48	H408-41800-481M1	
80	30	22	∅ 22.5	H408-41800-283M1	
100	37	30	48 x 48	H410-41800-481M1	
100	37	30	∅ 22.5	H410-41800-283M1	
125	45	37	48 x 48	H412-41800-481M1	
125	45	37	∅ 22.5	H412-41800-283M1	

* larger terminal capacity, see page 154

Further switching programmes from page 132.

Dimensions in mm:

Door interlock with **modular shaft extension**: Four hole front mounting

Setup of order code number		
Type	Switching progr.	Mtg. form
H412	41800	242M1
Order code no. H412-41800-242M1		

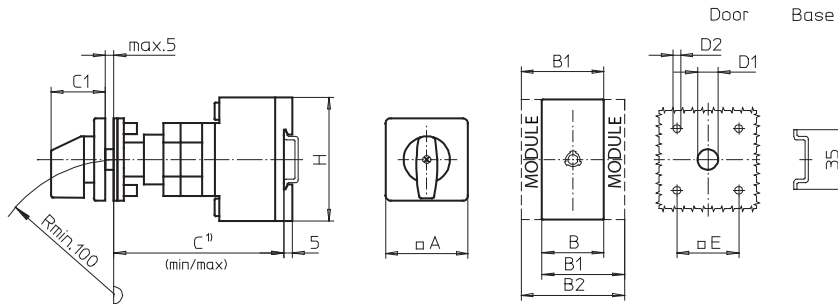

¹⁾ Internal depth: inside of door to top of DIN rail, dimensions with shaft extension see page 145.

Switching programmes 3 and 4 pole

Types H216 / H220 / H226 / H233:

Mtg. form	A	B	B1	B2	C _{min}	C _{max}	C1	D1	D2	E	H
242M1	48	36	48	60	92	107	32	12	4.5	36	70
248M1	64	36	48	60	92	107	39	15	5	48	70

Types B240 / B250 / B263:

Mtg. form	A	B	B1	B2	C _{min}	C _{max}	C1	D1	D2	E	H
242M1	48	50	69	88	92	107	32	12	4.5	36	72
248M1	64	50	69	88	92	107	39	15	5	48	72

Types H406 / H408 / H410 / H412:

Mtg. form	A	B	B1	B2	C _{min}	C _{max}	C1	D1	D2	E	H
242M1	64	70	89	108	102	117	40	15	5	48	80

Switching programmes 6 and 8 pole

Types H216 / H220 / H226 / H233:

Mtg. form	A	B	B1	B2	C _{min}	C _{max}	C1	D1	D2	E	H
248M1	64	72	84	96	100	115	39	15	5	48	70

Types B240 / B250 / B263:

Mtg. form	A	B	B1	B2	C _{min}	C _{max}	C1	D1	D2	E	H
248M1	64	100	119	138	104	119	39	15	5	48	72

Types H406 / H408 / H410 / H412:

Mtg. form	A	B	B1	B2	C _{min}	C _{max}	C1	D1	D2	E	H
242M1	64	140	159	178	115	130	40	15	5	48	80

Disconnect Switches

ON-OFF Switches **Base mounting** Snap-on mounting with door interlock

Dimensions in mm:

Door interlock with **metal shaft extension**: Four hole front mounting

Setup of order code number		
Type	Switching progr.	Mtg. form
H226	41400	481M1
Order code no.		H226-41400-481M1

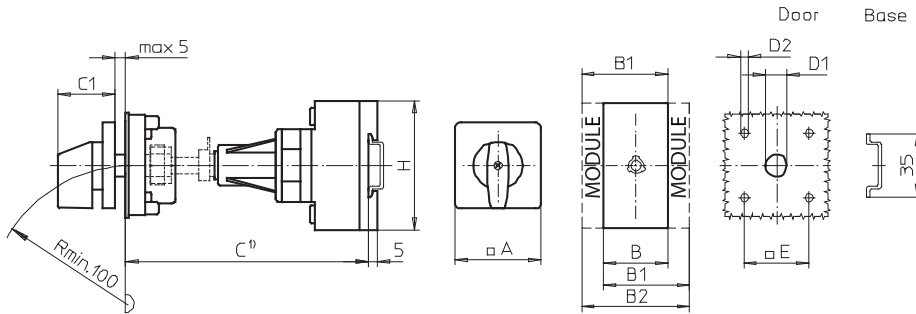

¹⁾ Internal depth: inside of door to top of DIN rail, dimensions see page 146.

Switching programmes 3 and 4 pole

Types H216 / H220 / H226 / H233:

Mtg. form	A	B	B1	B2	C1	D1	D2	E	H
481M1	48	36	48	60	32	15	4.5	36	70
482M1	64	36	48	60	39	15	5	48	70

Types B240 / B250 / B263:

Mtg. form	A	B	B1	B2	C1	D1	D2	E	H
481M1	48	50	69	88	32	15	4.5	36	72
482M1	64	50	69	88	39	15	5	48	72

Types H406 / H408 / H410 / H412:

Mtg. form	A	B	B1	B2	C1	D1	D2	E	H
481M1	64	70	89	108	40	15	5	48	80

Switching programmes 6 and 8 pole

Types H216 / H220 / H226 / H233:

Mtg. form	A	B	B1	B2	C1	D1	D2	E	H
482M1	64	72	84	96	39	15	5	48	70

Types B240 / B250 / B263:

Mtg. form	A	B	B1	B2	C1	D1	D2	E	H
482M1	64	100	119	138	39	15	5	48	72

Types H406 / H408 / H410 / H412:

Mtg. form	A	B	B1	B2	C1	D1	D2	E	H
481M1	64	140	159	178	40	15	5	48	80

Dimensions in mm:

Door interlock with **metal shaft extension**: Single hole front mounting

Setup of order code number		
Type	Switching progr.	Mtg. form
B250	41400	283M1
Order code no.	B250-41400-283M1	

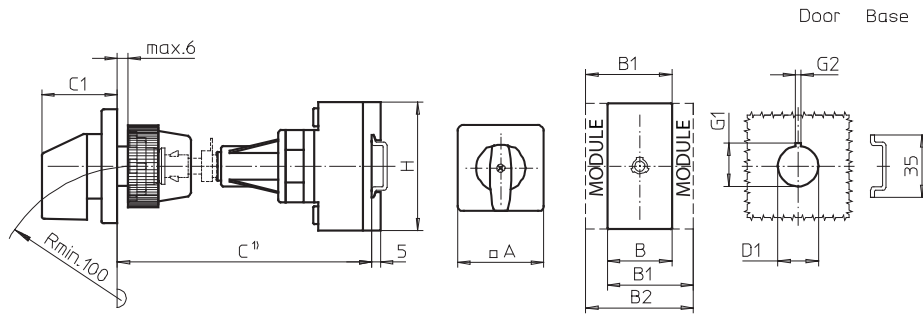

¹⁾ Internal depth: outside of door to top of DIN rail, dimensions see page 146.

Switching programmes 3 and 4 pole

Types H216 / H220 / H226 / H233:

Mtg. form	A	B	B1	B2	C1	D1	G1	G2	H
283M1	48	36	48	60	32	22.5	24.2	3.2	70

Types B240 / B250 / B263:

Mtg. form	A	B	B1	B2	C1	D1	G1	G2	H
283M1	48	50	69	88	32	22.5	24.2	3.2	72

Types H406 / H408 / H410 / H412:

Mtg. form	A	B	B1	B2	C1	D1	G1	G2	H
283M1	64	70	89	108	39	22.5	24.2	3.2	80

Switching programmes 6 and 8 pole

Types H216 / H220 / H226 / H233:

Mtg. form	A	B	B1	B2	C1	D1	G1	G2	H
285M1	64	72	84	96	39	22.5	24.2	3.2	70

Types B240 / B250 / B263:

Mtg. form	A	B	B1	B2	C1	D1	G1	G2	H
285M1	64	100	119	138	39	22.5	24.2	3.2	72

Types H406 / H408 / H410 / H412:

Mtg. form	A	B	B1	B2	C1	D1	G1	G2	H
283M1	64	140	159	178	39	22.5	24.2	3.2	80

Disconnect Switches

ON-OFF Switches **Base mounting** Four hole mounting with door interlock

ON-OFF Switches

- Base mounting switches with four hole mounting and door interlock
- 3 up to 8 pole
- 160 A up to 315 A
- IP55



Switching programme	Rated data (IEC 60947)			Mounting dimension (base/front) (mm)	G-handle silver/black
	Operat. current I _e	Operational power (at 380–440 V)			 IP55
	AC-21A (A)	AC-23A (kW)	AC-3 (kW)		Order code number
41300 – 3 pole – without auxiliary contacts	160	75	45	68 × 68 / 68 × 68	K616-41300-042G1
	315	132	55	104 × 104 / 104 × 104	K830-41300-042G1

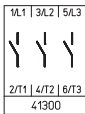

41400 – 4 pole – without auxiliary contacts – neutral contact early make/late break	160	75	45	68 × 68 / 68 × 68	K616-41400-042G1
	315	132	55	104 × 104 / 104 × 104	K830-41400-042G1

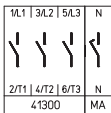

41600 – 6 pole – without auxiliary contacts	160	75	45	68 × 68 / 68 × 68	K616-41600-042G1
	315	132	55	104 × 104 / 104 × 104	K830-41600-042G1

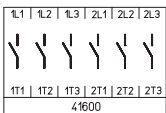

41800 – 8 pole – without auxiliary contacts – 2 neutral contacts early make/late break	160	75	45	68 × 68 / 68 × 68	K616-41800-042G1
	315	132	55	104 × 104 / 104 × 104	K830-41800-042G1

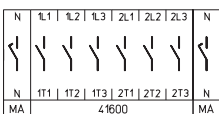

Dimensions in mm:

Setup of order code number

Type	Switching progr.	Mtg. form
K830	41300	042G1
Order code no.	K830-41300-042G1	

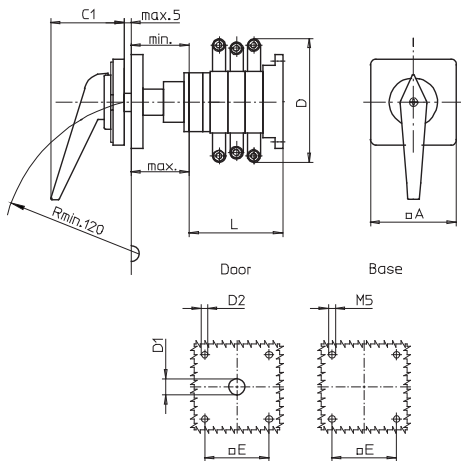

Type K616:

Switching progr.	A	C1	D*	D1	D2	E	min	max	L
41300	88	66	150	15	5.5	68	48	60	104
41400	88	66	150	15	5.5	68	48	60	104
41600	88	66	150	15	5.5	68	48	60	136
41800	88	66	150	15	5.5	68	48	60	168

Type K830:

Switching progr.	A	C1	D*	D1	D2	E	min	max	L
41300	130	74	210	20	5.5	104	75	102	125
41400	130	74	210	20	5.5	104	75	102	125
41600	130	74	210	20	5.5	104	75	102	161
41800	130	74	210	20	5.5	104	75	102	197

* terminal lugs included

Further switching programmes and corresponding dimensions for types K on request.

Disconnect Switches

ON-OFF Switches Enclosed Switches – Insulated Enclosure

ON-OFF Switches

- Enclosed switches with insulated enclosure (polycarbonate)
- Cover interlock in ON position
- 3 up to 8 pole
- 20 A up to 125 A
- IP66



Switching programme	Rated data (IEC 60947)			Enclosure dimension (H × W × D) (mm)	M-handle silver/black	IP66
	Operat. current I _e (A)	Operational power (at 380–440 V) (kW)			Order code number	
41300 – 3 pole – without auxiliary contacts 	20	5.5	3.7	125 × 100 × 85	H216-41300-701M1	
	20	5.5	3.7	175 × 115 × 100	H216-41300-711M1	
	20	5.5	3.7	250 × 160 × 120	H216-41300-731M1	
	25	7.5	5.5	125 × 100 × 85	H220-41300-701M1	
	25	7.5	5.5	175 × 115 × 100	H220-41300-711M1	
	25	7.5	5.5	250 × 160 × 120	H220-41300-731M1	
	32	11	7.5	125 × 100 × 85	H226-41300-701M1	
	32	11	7.5	175 × 115 × 100	H226-41300-711M1	
	32	11	7.5	250 × 160 × 120	H226-41300-731M1	
	40	15	11	175 × 115 × 100	H233-41300-711M1	
	40	15	11	175 × 115 × 100	B240-41300-711M1*¹	
	40	15	11	250 × 160 × 120	H233-41300-731M1	
	40	15	11	250 × 160 × 120	B240-41300-731M1*	
	50	18.5	15	175 × 115 × 100	B250-41300-711M1¹	
	50	18.5	15	250 × 160 × 120	B250-41300-731M1	
	63	22	18.5	175 × 115 × 100	B263-41300-711M1¹	
	63	22	18.5	250 × 160 × 120	B263-41300-731M1	
	63	22	18.5	250 × 160 × 120	H406-41300-731M1*	
	63	22	18.5	280 × 190 × 130	H406-41300-771M1	
	63	22	18.5	320 × 220 × 180	H406-41300-476M1	
80	30	22	250 × 160 × 120	H408-41300-731M1		
80	30	22	280 × 190 × 130	H408-41300-771M1		
80	30	22	320 × 220 × 180	H408-41300-476M1		
100	37	30	250 × 160 × 120	H410-41300-731M1		
100	37	30	280 × 190 × 130	H410-41300-771M1		
100	37	30	320 × 220 × 180	H410-41300-476M1		
125	45	37	320 × 220 × 180	H412-41300-476M1		

* larger terminal capacity, see page 154



¹ Terminal capacity max. 16 mm² on N-terminal and/or PE-terminal

Further switching programmes from page 132.

Disconnect Switches

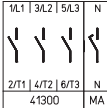

ON-OFF Switches Enclosed Switches – Insulated Enclosure

Switching programme	Rated data (IEC 60947)			Enclosure dimension (H × W × D) (mm)	M-handle silver/black	Order code number
	Operat. current I_e	Operational power (at 380–440 V)			IP66	
	AC-21A (A)	AC-23A (kW)	AC-3 (kW)			
41400 – 4 pole – without auxiliary contacts – neutral contact – early make/late break 	20	5.5	3.7	125 × 100 × 85	 	H216-41400-701M1
	20	5.5	3.7	175 × 115 × 100		H216-41400-711M1
	20	5.5	3.7	250 × 160 × 120		H216-41400-731M1
	25	7.5	5.5	125 × 100 × 85		H220-41400-701M1
	25	7.5	5.5	175 × 115 × 100		H220-41400-711M1
	25	7.5	5.5	250 × 160 × 120		H220-41400-731M1
	32	11	7.5	125 × 100 × 85		H226-41400-701M1
	32	11	7.5	175 × 115 × 100		H226-41400-711M1
	32	11	7.5	250 × 160 × 120		H226-41400-731M1
	40	15	11	175 × 115 × 100		H233-41400-711M1
	40	15	11	175 × 115 × 100		B240-41400-711M1*¹
	40	15	11	250 × 160 × 120		H233-41400-731M1
	40	15	11	250 × 160 × 120		B240-41400-731M1*
	50	18.5	15	175 × 115 × 100		B250-41400-711M1¹
	50	18.5	15	250 × 160 × 120		B250-41400-731M1
	63	22	18.5	175 × 115 × 100		B263-41400-711M1¹
	63	22	18.5	250 × 160 × 120		B263-41400-731M1
	63	22	18.5	250 × 160 × 120		H406-41400-731M1*
	63	22	18.5	280 × 190 × 130		H406-41400-771M1
	63	22	18.5	320 × 220 × 180		H406-41400-476M1
80	30	22	250 × 160 × 120		H408-41400-731M1	
80	30	22	280 × 190 × 130		H408-41400-771M1	
80	30	22	320 × 220 × 180		H408-41400-476M1	
100	37	30	250 × 160 × 120		H410-41400-731M1	
100	37	30	280 × 190 × 130		H410-41400-771M1	
100	37	30	320 × 220 × 180		H410-41400-476M1	
125	45	37	320 × 220 × 180		H412-41400-476M1	

* larger terminal capacity, see page 154

¹ Terminal capacity max. 16 mm² on N-terminal and/or PE-terminal

Further switching programmes from page 132.

Disconnect Switches

ON-OFF Switches Enclosed Switches – Insulated Enclosure

Switching programme	Rated data (IEC 60947)			Enclosure dimension (H × W × D) (mm)	M-handle silver/black	Order code number
	Operat. current I _e	Operational power (at 380–440 V)			IP66	
	AC-21A (A)	AC-23A (kW)	AC-3 (kW)			
41600 – 6 pole – without auxiliary contacts 	20	5.5	3.7	175 × 115 × 100	H216-41600-721M1	
	20	5.5	3.7	250 × 160 × 120	H216-41600-734M1	
	20	5.5	3.7	280 × 190 × 130	H216-41600-771M1	
	25	7.5	5.5	175 × 115 × 100	H220-41600-721M1	
	25	7.5	5.5	250 × 160 × 120	H220-41600-734M1	
	25	7.5	5.5	280 × 190 × 130	H220-41600-771M1	
	32	11	7.5	175 × 115 × 100	H226-41600-721M1	
	32	11	7.5	250 × 160 × 120	H226-41600-734M1	
	32	11	7.5	280 × 190 × 130	H226-41600-771M1	
	40	15	11	175 × 115 × 100	H233-41600-721M1	
	40	15	11	250 × 160 × 120	H233-41600-734M1	
	40	15	11	280 × 190 × 130	H233-41600-771M1	
	40	15	11	280 × 190 × 130	B240-41600-771M1* ¹	
	40	15	11	320 × 220 × 180	B240-41600-976M1	
	50	18.5	15	280 × 190 × 130	B250-41600-771M1 ¹	
	50	18.5	15	320 × 220 × 180	B250-41600-976M1	
	63	22	18.5	280 × 190 × 130	B263-41600-771M1 ¹	
	63	22	18.5	320 × 220 × 180	B263-41600-976M1	
	63	22	18.5	440 × 320 × 180	H406-41600-578M1	
	80	30	22	440 × 320 × 180	H408-41600-578M1	
100	37	30	440 × 320 × 180	H410-41600-578M1		
125	45	37	440 × 320 × 180	H412-41600-578M1		
41800 – 8 pole – without auxiliary contacts – 2 neutral contacts early make/late break 	20	5.5	3.7	250 × 160 × 120	H216-41800-734M1	
	20	5.5	3.7	280 × 190 × 130	H216-41800-771M1	
	25	7.5	5.5	250 × 160 × 120	H220-41800-734M1	
	25	7.5	5.5	280 × 190 × 130	H220-41800-771M1	
	32	11	7.5	250 × 160 × 120	H226-41800-734M1	
	32	11	7.5	280 × 190 × 130	H226-41800-771M1	
	40	15	11	250 × 160 × 120	H233-41800-734M1	
	40	15	11	280 × 190 × 130	H233-41800-771M1	
	40	15	11	280 × 190 × 130	B240-41800-771M1*	
	40	15	11	320 × 220 × 180	B240-41800-976M1	
	50	18.5	15	280 × 190 × 130	B250-41800-771M1	
	50	18.5	15	320 × 220 × 180	B250-41800-976M1	
	63	22	18.5	280 × 190 × 130	B263-41800-771M1	
	63	22	18.5	320 × 220 × 180	B263-41800-976M1	
	63	22	18.5	440 × 320 × 180	H406-41800-578M1	
	80	30	22	440 × 320 × 180	H408-41800-578M1	
100	37	30	440 × 320 × 180	H410-41800-578M1		
125	45	37	440 × 320 × 180	H412-41800-578M1		

* larger terminal capacity, see page 154

¹ Terminal capacity max. 16 mm² on N-terminal and/or PE-terminal

Further switching programmes from page 132.

Dimensions in mm:

Setup of order code number		
Type	Switching progr.	Mtg. form
B250	41400	711M1
Order code no. B250-41400-711M1		

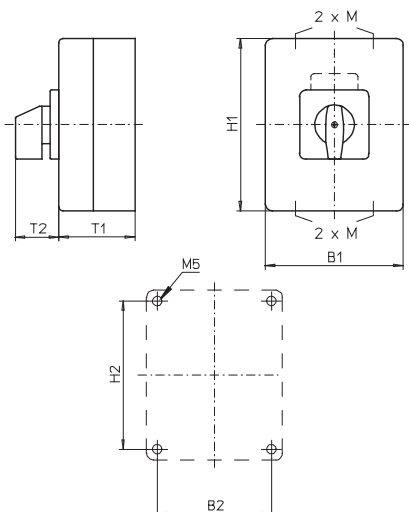
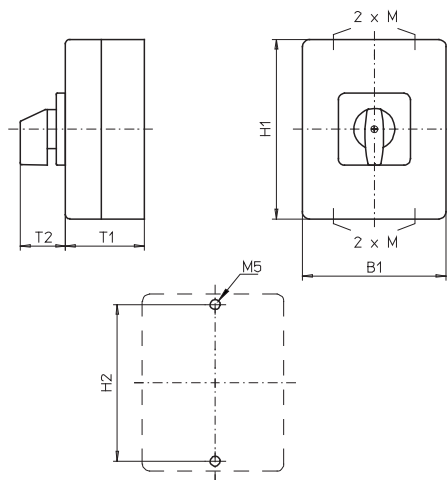
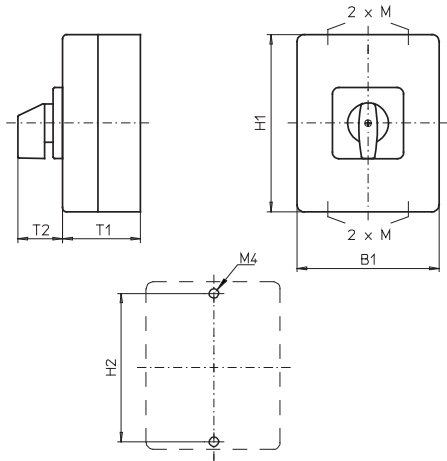

Insulated enclosures 125 × 100 × 85 mm and 175 × 115 × 100 mm:

Types H216 / H220 / H226 / H233 / B240 / B250 / B263:

Mtg. form	H1	B1	T1	T2	2×M	H2
701M1	125	100	85	32	20/25	115
711M1	175	115	100	39	20/25	165
721M1	175	115	100	39	20/25	165

Insulated enclosure 250 × 160 × 120 mm:

Types H216 / H220 / H226 / H233 / B240 / B250 / B263 / H406 / H408 / H410 / H412:

Mtg. form	H1	B1	T1	T2	2×M	H2
731M1	250	160	120	39	32/40	235
734M1	250	160	120	39	32/40	235

Insulated enclosure 280 × 190 × 130 mm:

Types H216 / H220 / H226 / H233:

Mtg. form	H1	B1	T1	T2	2×M	H2	B2
771M1	280	190	130	39	40×1.5	254	164

Types B240 / B250 / B263:

Mtg. form	H1	B1	T1	T2	2×M	H2	B2
771M1	280	190	130	39	40×1.5	254	164

Types H406 / H408 / H410 / H412:

Mtg. form	H1	B1	T1	T2	2×M	H2	B2
771M1	280	190	130	52	40×1.5	254	164

Disconnect Switches

ON-OFF Switches Enclosed Switches – Insulated Enclosure

Dimensions in mm:

Setup of order code number		
Type	Switching progr.	Mtg. form
H406	41600	578M1
Order code no.	H406-41600-578M1	

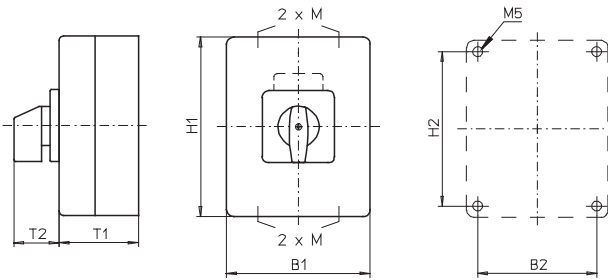

Insulated enclosure **320 × 220 × 180 mm:**

Types B240 / B250 / B263 / H406 / H408 / H410 / H412:

Mtg. form	H1	B1	T1	T2	2×M	H2	B2
476M1	320	220	180	52	50 ¹	293	193
976M1	320	220	180	52	- ²	293	193

¹ Gland plates with knockouts

² Blank gland plates

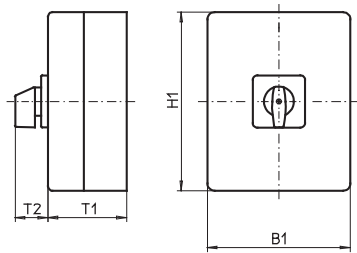

Insulated enclosure **440 × 320 × 180 mm:**

Types H406 / H408 / H410 / H412:

Mtg. form	H1	B1	T1	T2	H2	B2
578M1	440	320	180	52	480	293

Blank gland plates

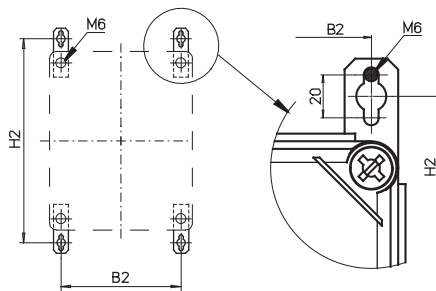

Mounting brackets are included.

ON-OFF Switches

- Enclosed switches with insulated enclosure (polycarbonate)
- EMV/EMC application, connection system for the uninterrupted connection of shielded/screened cables consisting of shroud and 4 shroud clamps \varnothing 12–16 mm
- Cover interlock in ON position
- 3 up to 6 pole
- 20 A up to 63 A
- IP66



Switching programme	Rated data (IEC 60947)			Enclosure dimension (H x W x D) (mm)	M-handle silver/black	IP66
	Operat. current I_e (A)	Operational power (at 380–440 V) (kW)				
41300 – 3 pole – without auxiliary contacts 	20	5.5	3.7	175 x 115 x 100	H216-41300-716M1	
	25	7.5	5.5	175 x 115 x 100	H220-41300-716M1	
	32	11	7.5	175 x 115 x 100	H226-41300-716M1	
	40	15	11	175 x 115 x 100	H233-41300-716M1	
	40	15	11	175 x 115 x 100	B240-41300-716M1*	
	50	18.5	15	175 x 115 x 100	B250-41300-716M1	
	63	22	18.5	175 x 115 x 100	B263-41300-716M1	
41400 – 4 pole – without auxiliary contacts – neutral contact early make/late break 	20	5.5	3.7	175 x 115 x 100	H216-41400-716M1	
	25	7.5	5.5	175 x 115 x 100	H220-41400-716M1	
	32	11	7.5	175 x 115 x 100	H226-41400-716M1	
	40	15	11	175 x 115 x 100	H233-41400-716M1	
	40	15	11	175 x 115 x 100	B240-41400-716M1*	
	50	18.5	15	175 x 115 x 100	B250-41400-716M1	
	63	22	18.5	175 x 115 x 100	B263-41400-716M1	
41600 – 6 pole – without auxiliary contacts 	20	5.5	3.7	175 x 115 x 100	H216-41600-726M1	
	25	7.5	5.5	175 x 115 x 100	H220-41600-726M1	
	32	11	7.5	175 x 115 x 100	H226-41600-726M1	
	40	15	11	175 x 115 x 100	H233-41600-726M1	

* larger terminal capacity, see page 154

Further switching programmes from page 132.

Dimensions in mm:

Types H216 / H220 / H226 / H233 / B240 / B250 / B263:

Mtg. form	H1	B1	T1	T2	2xM	H2
716M1	175	115	100	39	20/25	165
726M1	175	115	100	39	20/25	165

Disconnect Switches

ON-OFF Switches Enclosed Switches – Mild Steel Enclosure

ON-OFF Switches

- Enclosed switches with mild steel enclosure (powder coated – RAL 7035)
- Cover interlock in ON position
- 3 up to 8 pole
- 20 A up to 125 A
- IP66



Switching programme	Rated data (IEC 60947)			Enclosure dimension (H × W × D) (mm)	M-handle silver/black	IP66
	Operat. current I _e (A)	Operational power (at 380–440 V) AC-23A (kW)	AC-3 (kW)		Order code number	
41300 – 3 pole – without auxiliary contacts 	20	5.5	3.7	150 × 150 × 120	H216-41300-086M1	
	20	5.5	3.7	200 × 150 × 120	H216-41300-186M1	
	25	7.5	5.5	150 × 150 × 120	H220-41300-086M1	
	25	7.5	5.5	200 × 150 × 120	H220-41300-186M1	
	32	11	7.5	150 × 150 × 120	H226-41300-086M1	
	32	11	7.5	200 × 150 × 120	H226-41300-186M1	
	40	15	11	200 × 150 × 120	H233-41300-186M1	
	40	15	11	200 × 150 × 120	B240-41300-086M1*	
	50	18.5	15	200 × 150 × 120	B250-41300-086M1	
	63	22	18.5	200 × 150 × 120	B263-41300-086M1	
	63	22	18.5	200 × 150 × 120	H406-41300-986M1*	
	63	22	18.5	300 × 250 × 150	H406-41300-186M1	
	63	22	18.5	400 × 300 × 155	H406-41300-181M1¹	
	80	30	22	200 × 150 × 120	H408-41300-986M1	
	80	30	22	300 × 250 × 150	H408-41300-186M1	
	80	30	22	400 × 300 × 155	H408-41300-181M1¹	
	100	37	30	300 × 250 × 150	H410-41300-186M1	
	100	37	30	400 × 300 × 155	H410-41300-181M1¹	
125	45	37	300 × 250 × 150	H412-41300-186M1		
125	45	37	400 × 300 × 155	H412-41300-181M1¹		

* larger terminal capacity, see page 154

¹ hinged door

Further switching programmes from page 132.

Disconnect Switches

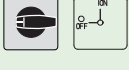
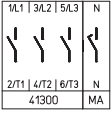
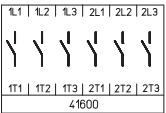
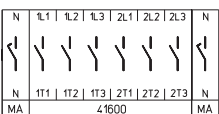

ON-OFF Switches Enclosed Switches – Mild Steel Enclosure

Switching programme	Rated data (IEC 60947)			Mounting dimension (mm)	M-handle silver/black	Order code number
	Operat. current I_e	Operational power (at 380–440 V)			 IP66	
	AC-21A (A)	AC-23A (kW)	AC-3 (kW)			
41400 – 4 pole – without auxiliary contacts – neutral contact early make/late break 	20	5.5	3.7	150 × 150 × 120	H216-41400-086M1	
	20	5.5	3.7	200 × 150 × 120	H216-41400-186M1	
	25	7.5	5.5	150 × 150 × 120	H220-41400-086M1	
	25	7.5	5.5	200 × 150 × 120	H220-41400-186M1	
	32	11	7.5	150 × 150 × 120	H226-41400-086M1	
	32	11	7.5	200 × 150 × 120	H226-41400-186M1	
	40	15	11	200 × 150 × 120	H233-41400-186M1	
	40	15	11	200 × 150 × 120	B240-41400-086M1*	
	50	18.5	15	200 × 150 × 120	B250-41400-086M1	
	63	22	18.5	200 × 150 × 120	B263-41400-086M1	
	63	22	18.5	200 × 150 × 120	H406-41400-986M1*	
	63	22	18.5	300 × 250 × 150	H406-41400-186M1	
	63	22	18.5	400 × 300 × 155	H406-41400-181M1¹	
	80	30	22	200 × 150 × 120	H408-41400-986M1	
	80	30	22	300 × 250 × 150	H408-41400-186M1	
	80	30	22	400 × 300 × 155	H408-41400-181M1¹	
	100	37	30	300 × 250 × 150	H410-41400-186M1	
100	37	30	400 × 300 × 155	H410-41400-181M1¹		
125	45	37	300 × 250 × 150	H412-41400-186M1		
125	45	37	400 × 300 × 155	H412-41400-181M1¹		
41600 – 6 pole – without auxiliary contacts 	20	5.5	3.7	200 × 150 × 120	H216-41600-186M1	
	25	7.5	5.5	200 × 150 × 120	H220-41600-186M1	
	32	11	7.5	200 × 150 × 120	H226-41600-186M1	
	40	15	11	200 × 150 × 120	H233-41600-186M1	
	40	15	11	300 × 250 × 150	B240-41600-186M1	
	50	18.5	15	300 × 250 × 150	B250-41600-186M1	
	63	22	18.5	300 × 250 × 150	B263-41600-186M1	
	63	22	18.5	300 × 250 × 150	H406-41600-186M1*	
	63	22	18.5	400 × 300 × 155	H406-41600-181M1¹	
	80	30	22	300 × 250 × 150	H408-41600-186M1	
	80	30	22	400 × 300 × 155	H408-41600-181M1¹	
	100	37	30	300 × 250 × 150	H410-41600-186M1	
	100	37	30	400 × 300 × 155	H410-41600-181M1¹	
125	45	37	300 × 250 × 150	H412-41600-186M1		
125	45	37	400 × 300 × 155	H412-41600-181M1¹		
41800 – 8 pole – without auxiliary contacts – 2 neutral contacts early make/late break 	20	5.5	3.7	200 × 150 × 120	H216-41800-186M1	
	25	7.5	5.5	200 × 150 × 120	H220-41800-186M1	
	32	11	7.5	200 × 150 × 120	H226-41800-186M1	
	40	15	11	200 × 150 × 120	H233-41800-186M1	
	40	15	11	300 × 250 × 150	B240-41800-186M1	
	50	18.5	15	300 × 250 × 150	B250-41800-186M1	
	63	22	18.5	300 × 250 × 150	B263-41800-186M1	
	63	22	18.5	300 × 250 × 150	H406-41800-186M1*	
	63	22	18.5	400 × 300 × 155	H406-41800-181M1¹	
	80	30	22	300 × 250 × 150	H408-41800-186M1	
	80	30	22	400 × 300 × 155	H408-41800-181M1¹	
	100	37	30	300 × 250 × 150	H410-41800-186M1	
	100	37	30	400 × 300 × 155	H410-41800-181M1¹	
125	45	37	300 × 250 × 150	H412-41800-186M1		
125	45	37	400 × 300 × 155	H412-41800-181M1¹		

* larger terminal capacity, see page 154

¹ hinged door

Further switching programmes from page 132.

Disconnect Switches

ON-OFF Switches Enclosed Switches – Mild Steel Enclosure

Dimensions in mm:

Setup of order code number

Type	Switching progr.	Mtg. form
H406	41400	186M1
Order code no.	H406-41400-186M1	

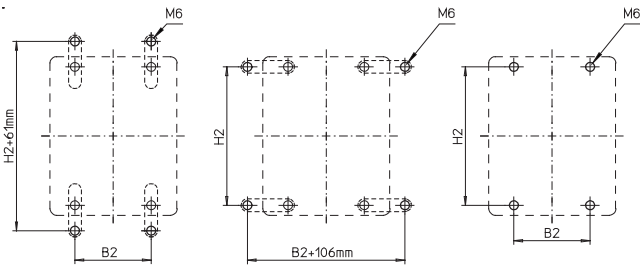
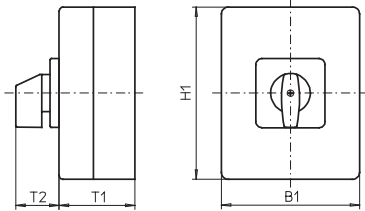

Please order mounting brackets separately, see page 148.

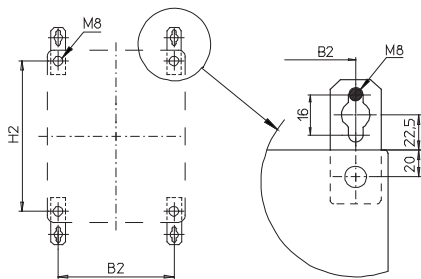
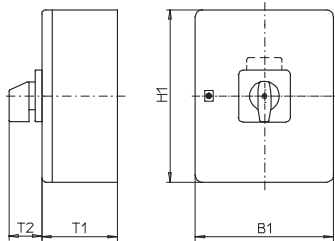

Please order mounting brackets separately, see page 148.

Mild steel enclosure **150 × 150 × 120 mm / 200 × 150 × 120 mm / 300 × 250 × 150 mm:**

Types H216 / H220 / H226 / H233:

Mtg. form	H1	B1	T1	T2	H2	B2
086M1	150	150	120	39	132	85
186M1	200	150	120	39	182	85

Types B240 / B250 / B263:

Mtg. form	H1	B1	T1	T2	H2	B2
086M1	200	150	120	39	182	85
186M1	300	250	150	52	282	185

Types H406 / H408 / H410 / H412:

Mtg. form	H1	B1	T1	T2	H2	B2
186M1	300	250	150	52	282	185
986M1	200	150	120	52	182	85

Mild steel enclosure **400 × 300 × 155 mm:**

Types H406 / H408 / H410 / H412:





Mtg. form	H1	B1	T1	T2	H2	B2
181M1	400	300	155	52	360	260

Gland plate at the bottom

ON-OFF Switches

- Enclosed switches with stainless steel enclosure (brushed)
- Cover interlock in ON position
- 3 up to 8 pole
- 20 A up to 125 A
- IP66

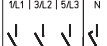
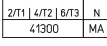

Switching programme	Rated data (IEC 60947)			Enclosure dimension (H × W × D) (mm)	M-handle silver/black	IP66
	Operat. current I _e (A)	Operational power (at 380–440 V) (kW)			 	
	AC-21A	AC-23A	AC-3		Order code number	
41300 – 3 pole – without auxiliary contacts   41300	20	5.5	3.7	150 × 150 × 120	H216-41300-096M1	
	20	5.5	3.7	200 × 150 × 120	H216-41300-196M1	
	25	7.5	5.5	150 × 150 × 120	H220-41300-096M1	
	25	7.5	5.5	200 × 150 × 120	H220-41300-196M1	
	32	11	7.5	150 × 150 × 120	H226-41300-096M1	
	32	11	7.5	200 × 150 × 120	H226-41300-196M1	
	40	15	11	200 × 150 × 120	H233-41300-196M1	
	40	15	11	200 × 150 × 120	B240-41300-096M1*	
	50	18.5	15	200 × 150 × 120	B250-41300-096M1	
	63	22	18.5	200 × 150 × 120	B263-41300-096M1	
	63	22	18.5	200 × 150 × 120	H406-41300-996M1*	
	63	22	18.5	300 × 250 × 150	H406-41300-196M1	
	80	30	22	200 × 150 × 120	H408-41300-996M1	
	80	30	22	300 × 250 × 150	H408-41300-196M1	
100	37	30	300 × 250 × 150	H410-41300-196M1		
125	45	37	300 × 250 × 150	H412-41300-196M1		

41400 – 4 pole – without auxiliary contacts – neutral contact early make/late break   41300 MA	20	5.5	3.7	150 × 150 × 120	H216-41400-096M1	
	20	5.5	3.7	200 × 150 × 120	H216-41400-196M1	
	25	7.5	5.5	150 × 150 × 120	H220-41400-096M1	
	25	7.5	5.5	200 × 150 × 120	H220-41400-196M1	
	32	11	7.5	150 × 150 × 120	H226-41400-096M1	
	32	11	7.5	200 × 150 × 120	H226-41400-196M1	
	40	15	11	200 × 150 × 120	H233-41400-196M1	
	40	15	11	200 × 150 × 120	B240-41400-096M1*	
	50	18.5	15	200 × 150 × 120	B250-41400-096M1	
	63	22	18.5	200 × 150 × 120	B263-41400-096M1	
	63	22	18.5	200 × 150 × 120	H406-41400-996M1*	
	63	22	18.5	300 × 250 × 150	H406-41400-196M1	
	80	30	22	200 × 150 × 120	H408-41400-996M1	
	80	30	22	300 × 250 × 150	H408-41400-196M1	
100	37	30	300 × 250 × 150	H410-41400-196M1		
125	45	37	300 × 250 × 150	H412-41400-196M1		

* larger terminal capacity, see page 154

Further switching programmes from page 132.

Disconnect Switches

ON-OFF Switches Enclosed Switches – Stainless Steel Enclosure

Switching programme	Rated data (IEC 60947)			Enclosure dimension (H × W × D) (mm)	M-handle silver/black
	Operat. current I _e	Operational power (at 380–440 V)			IP66
	AC-21A (A)	AC-23A (kW)	AC-3 (kW)		Order code number
41600 – 6 pole – without auxiliary contacts 	20	5.5	3.7	200 × 150 × 120	H216-41600-196M1
	25	7.5	5.5	200 × 150 × 120	H220-41600-196M1
	32	11	7.5	200 × 150 × 120	H226-41600-196M1
	40	15	11	200 × 150 × 120	H233-41600-196M1
	40	15	11	300 × 250 × 150	B240-41600-196M1
	50	18.5	15	300 × 250 × 150	B250-41600-196M1
	63	22	18.5	300 × 250 × 150	B263-41600-196M1
	63	22	18.5	300 × 250 × 150	H406-41600-196M1*
	80	30	22	300 × 250 × 150	H408-41600-196M1
	100	37	30	300 × 250 × 150	H410-41600-196M1
125	45	37	300 × 250 × 150	H412-41600-196M1	

41800 – 8 pole – without auxiliary contacts – 2 neutral contacts early make/late break 	20	5.5	3.7	200 × 150 × 120	H216-41800-196M1
	25	7.5	5.5	200 × 150 × 120	H220-41800-196M1
	32	11	7.5	200 × 150 × 120	H226-41800-196M1
	40	15	11	200 × 150 × 120	H233-41800-196M1
	40	15	11	300 × 250 × 150	B240-41800-196M1
	50	18.5	15	300 × 250 × 150	B250-41800-196M1
	63	22	18.5	300 × 250 × 150	B263-41800-196M1
	63	22	18.5	300 × 250 × 150	H406-41800-196M1*
	80	30	22	300 × 250 × 150	H408-41800-196M1
	100	37	30	300 × 250 × 150	H410-41800-196M1
125	45	37	300 × 250 × 150	H412-41800-196M1	

* larger terminal capacity, see page 154

Further switching programmes from page 132.

Dimensions in mm:

Setup of order code number

Type	Switching progr.	Mtg. form
B240	41800	196M1
Order code no.	B240-41800-196M1	

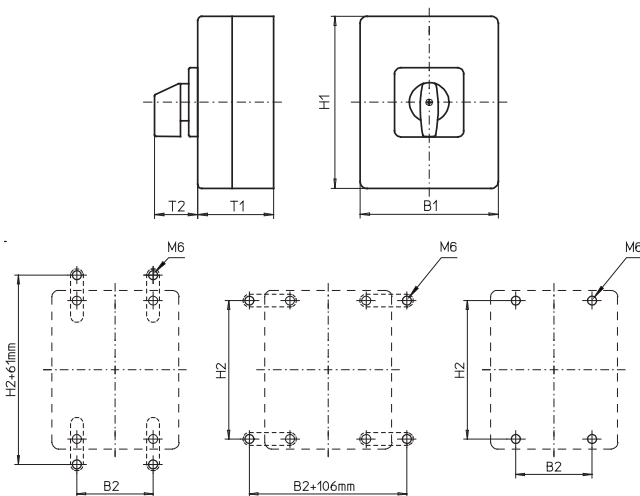

Please order mounting brackets separately, see page 148.

Types H216 / H220 / H226 / H233:

Mtg. form	H1	B1	T1	T2	H2	B2
096M1	150	150	120	39	132	85
196M1	200	150	120	39	182	85

Types B240 / B250 / B263:

Mtg. form	H1	B1	T1	T2	H2	B2
096M1	200	150	120	39	182	85
196M1	300	250	150	52	282	185

Types H406 / H408 / H410 / H412:

Mtg. form	H1	B1	T1	T2	H2	B2
196M1	300	250	150	52	282	185
996M1	200	150	120	52	182	85

Changeover Switches

- Front mounting switches with four hole mounting
- 3 up to 4 pole
- 20 A up to 315 A
- IP66 / IP55



Switching programme	Rated data (IEC 60947)			Mounting dimension (mm)	M-handle silver/black	Padlockable handle V-handle silver/black	Padlockable handle V-handle silver/black
	Operat. current I_e (A)	Operational power (at 380–440 V) (kW)			IP66	IP66	IP66
	AC-21A	AC-23A	AC-3			OFF position padlockable	all positions padlockable
	(A)	(kW)	(kW)		Order code number	Order code number	Order code number
71300 – 3 pole – without auxiliary contacts 	20	5.5	3.7	48 × 48	H216-71300-013M1	H216-71300-013V1	H216-71300-014V1
	25	7.5	5.5	48 × 48	H220-71300-013M1	H220-71300-013V1	H220-71300-014V1
	32	11	7.5	48 × 48	H226-71300-013M1	H226-71300-013V1	H226-71300-014V1
	40	15	11	48 × 48	H233-71300-013M1	H233-71300-013V1	H233-71300-014V1
	40	15	11	48 × 48	B240-71300-013M1*	B240-71300-013V1*	B240-71300-014V1*
	50	18.5	15	48 × 48	B250-71300-013M1	B250-71300-013V1	B250-71300-014V1
	63	22	18.5	48 × 48	B263-71300-013M1	B263-71300-013V1	B263-71300-014V1
	63	22	18.5	48 × 48	H406-71300-003M1*	H406-71300-003V1*	H406-71300-004V1*
	63	22	18.5	68 × 68	H406-71300-013M1	–	–
	80	30	22	48 × 48	H408-71300-003M1	H408-71300-003V1	H408-71300-004V1
	80	30	22	68 × 68	H408-71300-013M1	–	–
	100	37	30	48 × 48	H410-71300-003M1	H410-71300-003V1	H410-71300-004V1
	100	37	30	68 × 68	H410-71300-013M1	–	–
	125	45	37	48 × 48	H412-71300-003M1	H412-71300-003V1	H412-71300-004V1
125	45	37	68 × 68	H412-71300-013M1	–	–	







Rated data (IEC 60947)			Mounting dimension (mm)	G-handle silver/black	Padlock device H-handle silver/black	Padlock device H-handle silver/black
Operat. current I_e (A)	Operational power (at 380–440 V) (kW)			IP55	IP55	IP55
	AC-21A	AC-23A	AC-3		OFF position padlockable	all positions padlockable
	(A)	(kW)	(kW)	Order code number	Order code number	Order code number
160	75	45	68 × 68	K616-71300-003G1	K616-71300-003H1	K616-71300-004H1
160	75	45	104 × 104	K616-71300-013G1	K616-71300-013H1	K616-71300-014H1
315	132	55	104 × 104	K830-71300-003G1	K830-71300-003H1	K830-71300-004H1





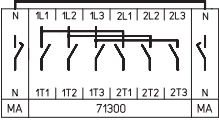

* larger terminal capacity, see page 154

Further switching programmes from page 132.

Disconnect Switches

Changeover Switches Front mounting Four hole mounting

Switching programme	Rated data (IEC 60947)			Mounting dimension (mm)	M-handle silver/black	Padlockable handle V-handle silver/black	Padlockable handle V-handle silver/black
	Operat. current I_e	Operational power (at 380–440 V)			  IP66	  OFF position padlockable IP66	  all positions padlockable IP66
	AC-21A (A)	AC-23A (kW)	AC-3 (kW)		Order code number	Order code number	Order code number
71500 – 4 pole – without auxiliary contacts – neutral contact – early make/late break – neutral jumper 	20	5.5	3.7	48 × 48	H216-71500-013M1	H216-71500-013V1	H216-71500-014V1
	25	7.5	5.5	48 × 48	H220-71500-013M1	H220-71500-013V1	H220-71500-014V1
	32	11	7.5	48 × 48	H226-71500-013M1	H226-71500-013V1	H226-71500-014V1
	40	15	11	48 × 48	H233-71500-013M1	H233-71500-013V1	H233-71500-014V1
	40	15	11	48 × 48	B240-71500-013M1*	B240-71500-013V1*	B240-71500-014V1*
	50	18.5	15	48 × 48	B250-71500-013M1	B250-71500-013V1	B250-71500-014V1
	63	22	18.5	48 × 48	B263-71500-013M1	B263-71500-013V1	B263-71500-014V1
	63	22	18.5	48 × 48	H406-71500-003M1*	H406-71500-003V1*	H406-71500-004V1*
	63	22	18.5	68 × 68	H406-71500-013M1	–	–
	80	30	22	48 × 48	H408-71500-003M1	H408-71500-003V1	H408-71500-004V1
	80	30	22	68 × 68	H408-71500-013M1	–	–
	100	37	30	48 × 48	H410-71500-003M1	H410-71500-003V1	H410-71500-004V1
	100	37	30	68 × 68	H410-71500-013M1	–	–
	125	45	37	48 × 48	H412-71500-003M1	H412-71500-003V1	H412-71500-004V1
	125	45	37	68 × 68	H412-71500-013M1	–	–

Rated data (IEC 60947)	Mounting dimension (mm)	G-handle silver/black	Padlock device H-handle silver/black	Padlock device H-handle silver/black
		  IP55	  OFF position padlockable IP55	  all positions padlockable IP55
Operat. current I_e	Operational power (at 380–440 V)	Order code number	Order code number	Order code number
AC-21A (A)	AC-23A (kW)	AC-3 (kW)		
160	75	45	K616-71500-003G1	K616-71500-003H1
160	75	45	K616-71500-013G1	K616-71500-013H1
315	132	55	K830-71500-003G1	K830-71500-003H1

* larger terminal capacity, see page 154

Further switching programmes from page 132.

Dimensions in mm:

Setup of order code number

Type	Switching progr.	Mtg. form
H412	71300	013M1
Order code no. H412-71300-013M1		

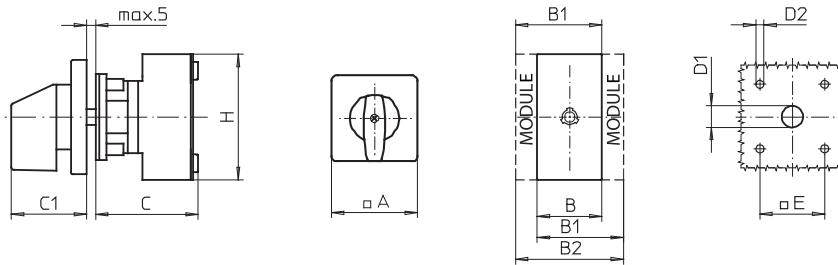

Types H216 / H220 / H226 / H233:

Mtg. form	A	B	B1	B2	C	C1	D1	D2	E	H
013M1	64	72	84	96	66	39	15	5	48	70
013V1	64	72	84	96	66	39	15	5	48	70
014V1	64	72	84	96	66	39	15	5	48	70

Types H406 / H408 / H410 / H412:

Mtg. form	A	B	B1	B2	C	C1	D1	D2	E	H
003M1	64	140	159	178	86	39	15	5	48	80
003V1	64	140	159	178	86	39	15	5	48	80
004V1	64	140	159	178	86	39	15	5	48	80
013M1	88	140	159	178	86	52	15	5.5	68	80

Types B240 / B250 / B263:

Mtg. form	A	B	B1	B2	C	C1	D1	D2	E	H
013M1	64	100	119	138	70	39	15	5	48	72
013V1	64	100	119	138	70	39	15	5	48	72
014V1	64	100	119	138	70	39	15	5	48	72

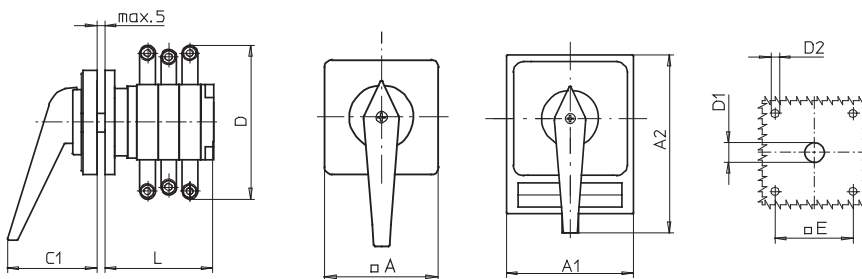

Type K616:

Mtg. form	Switching progr.	A	A1	A2	C1	D*	D1	D2	E	L
003G1	71300	88	-	-	66	150	20	5.5	68	136
003G1	71500	88	-	-	66	150	20	5.5	68	168
003H1	71300	-	98	142	83	150	20	5.5	68	136
003H1	71500	-	98	142	83	150	20	5.5	68	168
004H1	71300	-	98	142	83	150	20	5.5	68	136
004H1	71500	-	98	142	83	150	20	5.5	68	168
013G1	71300	130	-	-	74	150	20	5.5	104	136
013G1	71500	130	-	-	74	150	20	5.5	104	168
013H1	71300	-	130	176	93	150	20	5.5	104	136
013H1	71500	-	130	176	93	150	20	5.5	104	168
014H1	71300	-	130	176	93	150	20	5.5	104	136
014H1	71500	-	130	176	93	150	20	5.5	104	168

Type K830:

Mtg. form	Switching progr.	A	A1	A2	C1	D*	D1	D2	E	L
003G1	71300	130	-	-	74	210	20	5.5	104	161
003G1	71500	130	-	-	74	210	20	5.5	104	197
003H1	71300	-	130	178	93	210	20	5.5	104	161
003H1	71500	-	130	178	93	210	20	5.5	104	197
004H1	71300	-	130	178	93	210	20	5.5	104	161
004H1	71500	-	130	178	93	210	20	5.5	104	197

Further switching programmes and corresponding dimensions for types K on request.

* terminal lugs included







Disconnect Switches

Changeover Switches **Front mounting** Single hole mounting

Changeover Switches

- Front mounting switches with single hole mounting
- 3 up to 4 pole
- 20 A up to 40 A
- IP66

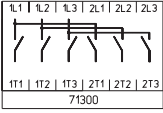
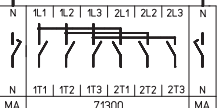

Switching programme	Rated data (IEC 60947)			Mounting dimension (mm)	M-handle silver/black	Padlockable handle V-handle silver/black	Padlockable handle V-handle silver/black
	Operat. current I _e	Operational power (at 380–440 V)			 	  OFF position padlockable	  all positions padlockable
	AC-21A (A)	AC-23A (kW)	AC-3 (kW)		IP66	IP66	IP66
					Order code number	Order code number	Order code number
71300 – 3 pole – without auxiliary contacts 	20	5.5	3.7	∅ 22.5	H216-71300-214M1	H216-71300-214V1	H216-71300-213V1
	20	5.5	3.7	∅ 30.5	H216-71300-204M1	H216-71300-204V1	H216-71300-203V1
	25	7.5	5.5	∅ 22.5	H220-71300-214M1	H220-71300-214V1	H220-71300-213V1
	25	7.5	5.5	∅ 30.5	H220-71300-204M1	H220-71300-204V1	H220-71300-203V1
	32	11	7.5	∅ 22.5	H226-71300-214M1	H226-71300-214V1	H226-71300-213V1
	32	11	7.5	∅ 30.5	H226-71300-204M1	H226-71300-204V1	H226-71300-203V1
	40	15	11	∅ 22.5	H233-71300-214M1	H233-71300-214V1	H233-71300-213V1
	40	15	11	∅ 30.5	H233-71300-204M1	H233-71300-204V1	H233-71300-203V1
71500 – 4 pole – without auxiliary contacts – neutral contact – early make/late break – neutral jumper 	20	5.5	3.7	∅ 22.5	H216-71500-214M1	H216-71500-214V1	H216-71500-213V1
	20	5.5	3.7	∅ 30.5	H216-71500-204M1	H216-71500-204V1	H216-71500-203V1
	25	7.5	5.5	∅ 22.5	H220-71500-214M1	H220-71500-214V1	H220-71500-213V1
	25	7.5	5.5	∅ 30.5	H220-71500-204M1	H220-71500-204V1	H220-71500-203V1
	32	11	7.5	∅ 22.5	H226-71500-214M1	H226-71500-214V1	H226-71500-213V1
	32	11	7.5	∅ 30.5	H226-71500-204M1	H226-71500-204V1	H226-71500-203V1
	40	15	11	∅ 22.5	H233-71500-214M1	H233-71500-214V1	H233-71500-213V1
	40	15	11	∅ 30.5	H233-71500-204M1	H233-71500-204V1	H233-71500-203V1

Further switching programmes from page 132.

Dimensions in mm:

Setup of order code number		
Type	Switching progr.	Mtg. form
H216	71300	214M1
Order code no. H216-71300-214M1		

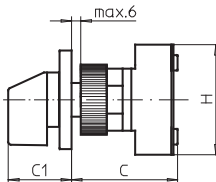
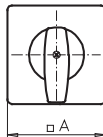
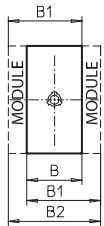
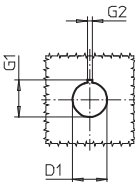
Types H216 / H220 / H226 / H233:										
Mtg. form	A	B	B1	B2	C	C1	D1	G1	G2	H
203V1	64	72	84	96	83	39	30.5	33	4.8	70
204M1	64	72	84	96	83	39	30.5	33	4.8	70
204V1	64	72	84	96	83	39	30.5	33	4.8	70
213V1	64	72	84	96	83	39	22.5	24.2	3.2	70
214M1	64	72	84	96	83	39	22.5	24.2	3.2	70
214V1	64	72	84	96	83	39	22.5	24.2	3.2	70

Changeover Switches

- Base mounting switches with snap-on mounting
- for DIN rail
- 3 up to 4 pole
- 20 A up to 125 A
- IP30



Switching programme	Rated data (IEC 60947)			Escutcheon dimension for 45 mm aperture in Panel/Distribution boards (H × W) (mm)	M-handle silver/black	Padlockable handle V-handle silver/black	Padlockable handle V-handle silver/black
	Operat. current I _e (A)	Operational power (at 380–440 V) (kW)	AC-3 (kW)		IP30	OFF position padlockable IP30	all positions padlockable IP30
	AC-21A (A)	AC-23A (kW)	AC-3 (kW)		Order code number	Order code number	Order code number
71300 – 3 pole – without auxiliary contacts 	20	5.5	3.7	45 × 76	H216-71300-026M1	H216-71300-028V1	H216-71300-027V1
	25	7.5	5.5	45 × 76	H220-71300-026M1	H220-71300-028V1	H220-71300-027V1
	32	11	7.5	45 × 76	H226-71300-026M1	H226-71300-028V1	H226-71300-027V1
	40	15	11	45 × 76	H233-71300-026M1	H233-71300-028V1	H233-71300-027V1
	40	15	11	45 × 105	B240-71300-026M1*	B240-71300-028V1*	B240-71300-027V1*
	50	18.5	15	45 × 105	B250-71300-026M1	B250-71300-028V1	B250-71300-027V1
	63	22	18.5	45 × 105	B263-71300-026M1	B263-71300-028V1	B263-71300-027V1
	63	22	18.5	45 × 72	H406-71300-126M1*	H406-71300-128V1*	H406-71300-127V1*
	80	30	22	45 × 72	H408-71300-126M1	H408-71300-128V1	H408-71300-127V1
	100	37	30	45 × 72	H410-71300-126M1	H410-71300-128V1	H410-71300-127V1
	125	45	37	45 × 72	H412-71300-126M1	H412-71300-128V1	H412-71300-127V1
71500 – 4 pole – without auxiliary contacts – neutral contact – early make/late break – neutral jumper 	20	5.5	3.7	45 × 76	H216-71500-026M1	H216-71500-028V1	H216-71500-027V1
	25	7.5	5.5	45 × 76	H220-71500-026M1	H220-71500-028V1	H220-71500-027V1
	32	11	7.5	45 × 76	H226-71500-026M1	H226-71500-028V1	H226-71500-027V1
	40	15	11	45 × 76	H233-71500-026M1	H233-71500-028V1	H233-71500-027V1
	40	15	11	45 × 105	B240-71500-026M1*	B240-71500-028V1*	B240-71500-027V1*
	50	18.5	15	45 × 105	B250-71500-026M1	B250-71500-028V1	B250-71500-027V1
	63	22	18.5	45 × 105	B263-71500-026M1	B263-71500-028V1	B263-71500-027V1
	63	22	18.5	45 × 72	H406-71500-126M1*	H406-71500-128V1*	H406-71500-127V1*
	80	30	22	45 × 72	H408-71500-126M1	H408-71500-128V1	H408-71500-127V1
	100	37	30	45 × 72	H410-71500-126M1	H410-71500-128V1	H410-71500-127V1
	125	45	37	45 × 72	H412-71500-126M1	H412-71500-128V1	H412-71500-127V1

* larger terminal capacity, see page 154

Further switching programmes from page 132.

Disconnect Switches

Changeover Switches **Base mounting** Snap-on mounting for DIN rail

Dimensions in mm:

Setup of order code number		
Type	Switching progr.	Mtg. form
H406	71300	128V1
Order code no.	H406-71300-128V1	

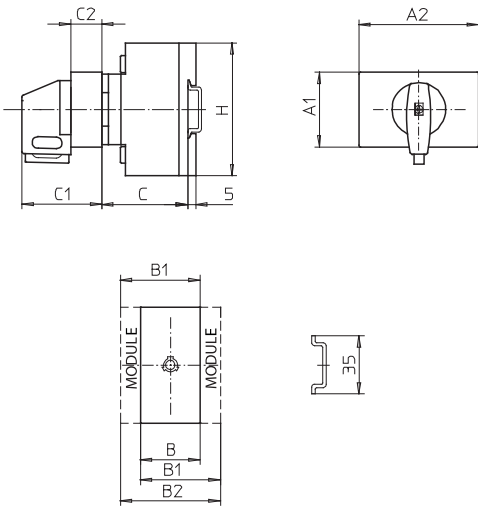

Types H216 / H220 / H226 / H233:

Mtg. form	A1	A2	B	B1	B2	C	C1	C2	H
026M1	45	76	72	84	96	40	51.5	25.5	70
027V1	45	76	72	84	96	40	51.5	25.5	70
028V1	45	76	72	84	96	40	51.5	25.5	70

Types B240 / B250 / B263:

Mtg. form	A1	A2	B	B1	B2	C	C1	C2	H
026M1	45	105	100	119	138	40	51.5	25.5	72
027V1	45	105	100	119	138	40	51.5	25.5	72
028V1	45	105	100	119	138	40	51.5	25.5	72

Types H406 / H408 / H410 / H412:

Mtg. form	A1	A2	B	B1	B2	C	C1	C2	H
126M1	45	72	140	159	178	67	48	16	80
127V1	45	72	140	159	178	67	48	16	80
128V1	45	72	140	159	178	67	48	16	80

Changeover Switches

- Base mounting switches with snap-on mounting
- Door interlock
- 3 up to 4 pole
- 20 A up to 125 A
- **IP66**
- with modular or metal shaft extension
- Single or four hole front mounting



Base mounting switches with snap-on mounting and door interlock are offered with two different extensions:

1. Switches with **modular shaft extensions** can be extended with additional modules (modular shaft extensions see picture) which can be fixed to achieve different required mounting depths – dimension C. The modules therefore are detailed on page 145.

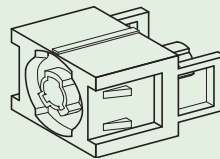
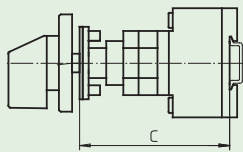

AVC2/AVC4
Modular shaft extension

2. For switches with **metal shaft extension** the metal shaft is not included in the scope of delivery and has to be ordered separately. Data for mounting dimension C and for the different types of metal shafts can be found on page 146.

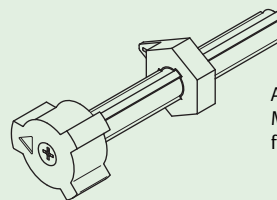
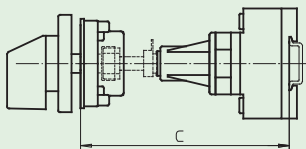



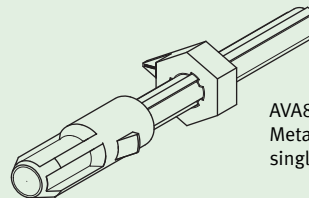
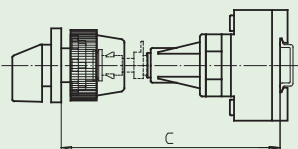



AVB8
Metal shaft extension for
four hole front mounting



AVA8
Metal shaft extension for
single hole front mounting

Disconnect Switches

Changeover Switches **Base mounting** Snap-on mounting with door interlock

Switching programme	Rated data (IEC 60947)			Mounting dimension (front) (mm)	M-handle silver/black	Padlockable handle V-handle silver/black	Padlockable handle V-handle silver/black
	Operat. current I_e	Operational power (at 380–440 V)			 	 	 
	AC-21A (A)	AC-23A (kW)	AC-3 (kW)		IP66	IP66	IP66
					Order code number	Order code number	Order code number

71300
– 3 pole
– without auxiliary contacts

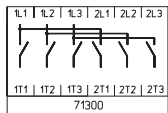

Modular shaft extension:

→ Modular shaft extensions see page 145!

20	25	32	40	40	50	63	63	80	100	125
5.5	7.5	11	15	15	18.5	22	22	30	37	45
3.7	5.5	7.5	11	11	15	18.5	18.5	22	30	37
48 x 48	48 x 48	48 x 48	48 x 48	48 x 48	48 x 48	48 x 48	48 x 48	48 x 48	48 x 48	48 x 48
H216-71300-248M1	H220-71300-248M1	H226-71300-248M1	H233-71300-248M1	B240-71300-248M1*	B250-71300-248M1	B263-71300-248M1	H406-71300-242M1*	H408-71300-242M1	H410-71300-242M1	H412-71300-242M1
H216-71300-248V1	H220-71300-248V1	H226-71300-248V1	H233-71300-248V1	B240-71300-248V1*	B250-71300-248V1	B263-71300-248V1	H406-71300-242V1*	H408-71300-242V1	H410-71300-242V1	H412-71300-242V1
H216-71300-249V1	H220-71300-249V1	H226-71300-249V1	H233-71300-249V1	B240-71300-249V1*	B250-71300-249V1	B263-71300-249V1	H406-71300-243V1*	H408-71300-243V1	H410-71300-243V1	H412-71300-243V1



Metal shaft extension:

→ Metal shaft is not included. Please order separately, see page 146!

20	20	25	25	32	32	40	40	40	40	50	50	63	63	63	63	80	80	100	100	125	125
5.5	5.5	7.5	7.5	11	11	15	15	15	15	18.5	18.5	22	22	22	22	30	30	37	37	45	45
3.7	3.7	5.5	5.5	7.5	7.5	11	11	11	11	15	15	18.5	18.5	18.5	18.5	22	22	30	30	37	37
48 x 48	∅ 22.5	48 x 48	∅ 22.5	48 x 48	∅ 22.5	48 x 48	48 x 48	48 x 48	48 x 48	48 x 48	∅ 22.5	48 x 48	48 x 48	∅ 22.5	∅ 22.5	48 x 48	∅ 22.5	48 x 48	48 x 48	48 x 48	∅ 22.5
H216-71300-482M1	H216-71300-285M1	H220-71300-482M1	H220-71300-285M1	H226-71300-482M1	H226-71300-285M1	H233-71300-482M1	B240-71300-482M1*	H233-71300-285M1	B240-71300-285M1*	B250-71300-482M1	B250-71300-285M1	B263-71300-482M1	H406-71300-481M1*	B263-71300-285M1	H406-71300-283M1*	H408-71300-481M1	H408-71300-283M1	H410-71300-481M1	H410-71300-283M1	H412-71300-481M1	H412-71300-283M1
H216-71300-482V1	H216-71300-285V1	H220-71300-482V1	H220-71300-285V1	H226-71300-482V1	H226-71300-285V1	H233-71300-482V1	B240-71300-482V1*	H233-71300-285V1	B240-71300-285V1*	B250-71300-482V1	B250-71300-285V1	B263-71300-482V1	H406-71300-481V1*	B263-71300-285V1	H406-71300-283V1*	H408-71300-481V1	H408-71300-283V1	H410-71300-481V1	H410-71300-283V1	H412-71300-481V1	H412-71300-283V1
H216-71300-449V1	H216-71300-291V1	H220-71300-449V1	H220-71300-291V1	H226-71300-449V1	H226-71300-291V1	H233-71300-449V1	B240-71300-449V1*	H233-71300-291V1	B240-71300-291V1*	B250-71300-449V1	B250-71300-291V1	B263-71300-449V1	H406-71300-485V1*	B263-71300-291V1	H406-71300-293V1*	H408-71300-485V1	H408-71300-293V1	H410-71300-485V1	H410-71300-293V1	H412-71300-485V1	H412-71300-293V1

* larger terminal capacity, see page 154

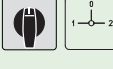
Further switching programmes from page 132.

Switching programme	Rated data (IEC 60947)			Mounting dimension (front) (mm)	M-handle silver/black	Padlockable handle V-handle silver/black	Padlockable handle V-handle silver/black
	Operat. current I_e	Operational power (at 380–440 V)			 IP66	 OFF position padlockable IP66	 all positions padlockable IP66
	AC-21A (A)	AC-23A (kW)	AC-3 (kW)		Order code number	Order code number	Order code number

71500

- 4 pole
- without auxiliary contacts
- neutral contact
- early make/late break
- neutral jumper

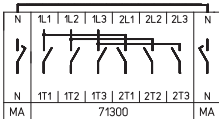

Modular shaft extension:

→ Modular shaft extensions see page 145!

20	25	32	40	40	50	63	63	80	100	125
5.5	7.5	11	15	15	18.5	22	22	30	37	45
3.7	5.5	7.5	11	11	15	18.5	18.5	22	30	37
48 x 48	48 x 48	48 x 48	48 x 48	48 x 48	48 x 48	48 x 48	48 x 48	48 x 48	48 x 48	48 x 48
H216-71500-248M1	H220-71500-248M1	H226-71500-248M1	H233-71500-248M1	B240-71500-248M1*	B250-71500-248M1	B263-71500-248M1	H406-71500-242M1*	H408-71500-242M1	H410-71500-242M1	H412-71500-242M1
H216-71500-248V1	H220-71500-248V1	H226-71500-248V1	H233-71500-248V1	B240-71500-248V1*	B250-71500-248V1	B263-71500-248V1	H406-71500-242V1*	H408-71500-242V1	H410-71500-242V1	H412-71500-242V1
H216-71500-249V1	H220-71500-249V1	H226-71500-249V1	H233-71500-249V1	B240-71500-249V1*	B250-71500-249V1	B263-71500-249V1	H406-71500-243V1*	H408-71500-243V1	H410-71500-243V1	H412-71500-243V1

Metal shaft extension:

→ Metal shaft is not included. Please order separately, see page 146!

20	20	25	25	32	32	40	40	40	40	50	50	63	63	63	63	80	80	100	100	125	125
5.5	5.5	7.5	7.5	11	11	15	15	15	15	18.5	18.5	22	22	22	22	30	30	37	37	45	45
3.7	3.7	5.5	5.5	7.5	7.5	11	11	11	11	15	15	18.5	18.5	18.5	18.5	22	22	30	30	37	37
48 x 48	∅ 22.5	48 x 48	∅ 22.5	48 x 48	∅ 22.5	48 x 48	48 x 48	48 x 48	∅ 22.5	48 x 48	∅ 22.5	48 x 48	48 x 48	∅ 22.5	∅ 22.5	48 x 48	∅ 22.5	48 x 48	∅ 22.5	48 x 48	∅ 22.5
H216-71500-482M1	H216-71500-285M1	H220-71500-482M1	H220-71500-285M1	H226-71500-482M1	H226-71500-285M1	H233-71500-482M1	B240-71500-482M1*	H233-71500-285M1	B240-71500-285M1*	B250-71500-482M1	B250-71500-285M1	B263-71500-482M1	H406-71500-481M1*	B263-71500-285M1	H406-71500-283M1*	H408-71500-481M1	H408-71500-283M1	H410-71500-481M1	H410-71500-283M1	H412-71500-481M1	H412-71500-283M1
H216-71500-482V1	H216-71500-285V1	H220-71500-482V1	H220-71500-285V1	H226-71500-482V1	H226-71500-285V1	H233-71500-482V1	B240-71500-482V1*	H233-71500-285V1	B240-71500-285V1*	B250-71500-482V1	B250-71500-285V1	B263-71500-482V1	H406-71500-481V1*	B263-71500-285V1	H406-71500-283V1*	H408-71500-481V1	H408-71500-283V1	H410-71500-481V1	H410-71500-283V1	H412-71500-481V1	H412-71500-283V1
H216-71500-449V1	H216-71500-291V1	H220-71500-449V1	H220-71500-291V1	H226-71500-449V1	H226-71500-291V1	H233-71500-449V1	B240-71500-449V1*	H233-71500-291V1	B240-71500-291V1*	B250-71500-449V1	B250-71500-291V1	B263-71500-449V1	H406-71500-485V1*	B263-71500-291V1	H406-71500-293V1*	H408-71500-485V1	H408-71500-293V1	H410-71500-485V1	H410-71500-293V1	H412-71500-485V1	H412-71500-293V1

* larger terminal capacity, see page 154

Further switching programmes from page 132.

Disconnect Switches

Changeover Switches **Base mounting** Snap-on mounting with door interlock

Dimensions in mm:

Setup of order code number		
Type	Switching progr.	Mtg. form
H233	71500	482V1
Order code no.	H233-71500-482V1	

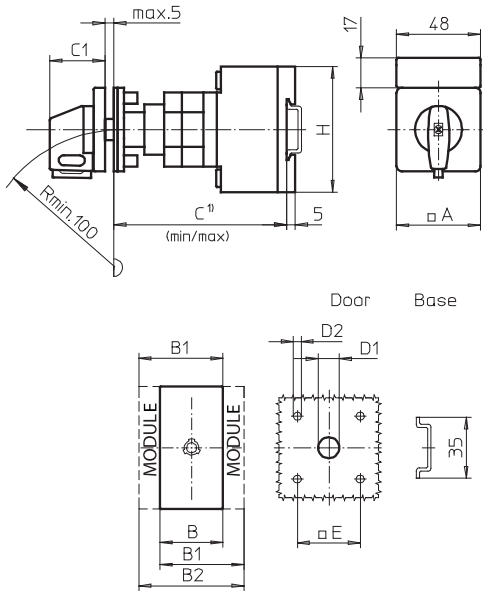

¹⁾ Internal depth: inside of door to top of DIN rail, dimensions with shaft extension see page 145.

Door interlock with **modular shaft extension**:
Four hole front mounting

Types H216 / H220 / H226 / H233:

Mtg. form	A	B	B1	B2	C _{min}	C _{max}	C1	D1	D2	E	H
248M1	64	72	84	96	100	115	39	15	5	48	70
248V1	64	72	84	96	100	115	39	15	5	48	70
249V1	64	72	84	96	100	115	39	15	5	48	70

Types B240 / B250 / B263:

Mtg. form	A	B	B1	B2	C _{min}	C _{max}	C1	D1	D2	E	H
248M1	64	100	119	138	104	119	39	15	5	48	72
248V1	64	100	119	138	104	119	39	15	5	48	72
249V1	64	100	119	138	104	119	39	15	5	48	72

Types H406 / H408 / H410 / H412:

Mtg. form	A	B	B1	B2	C _{min}	C _{max}	C1	D1	D2	E	H
242M1	64	140	159	178	115	130	40	15	5	48	80
242V1	64	140	159	178	115	130	40	15	5	48	80
243V1	64	140	159	178	115	130	40	15	5	48	80

Door interlock with **metal shaft extension**:
Four hole front mounting

Types H216 / H220 / H226 / H233:

Mtg. form	A	B	B1	B2	C1	D1	D2	E	H
449V1	64	72	84	96	39	15	5	48	70
482M1	64	72	84	96	39	15	5	48	70
482V1	64	72	84	96	39	15	5	48	70

Types B240 / B250 / B263:

Mtg. form	A	B	B1	B2	C1	D1	D2	E	H
449V1	64	100	119	138	39	15	5	48	72
482M1	64	100	119	138	39	15	5	48	72
482V1	64	100	119	138	39	15	5	48	72

Types H406 / H408 / H410 / H412:

Mtg. form	A	B	B1	B2	C1	D1	D2	E	H
481M1	64	140	159	178	40	15	5	48	80
481V1	64	140	159	178	40	15	5	48	80
485V1	64	140	159	178	40	15	5	48	80

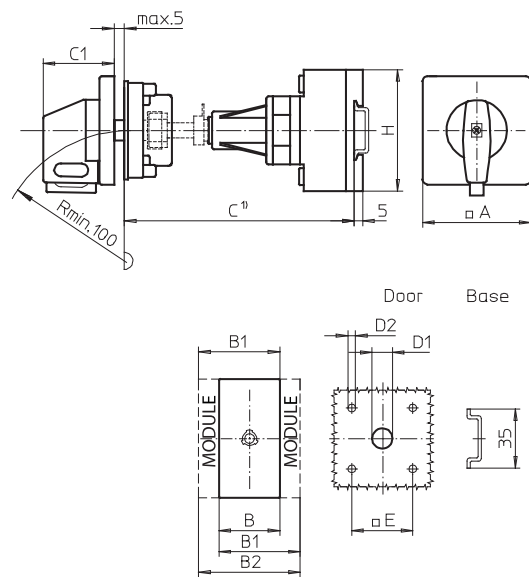

¹⁾ Internal depth: inside of door to top of DIN rail, dimensions see page 146.

Dimensions in mm:

Setup of order code number		
Type	Switching progr.	Mtg. form
B240	71500	285V1
Order code no.	B240-71500-285V1	

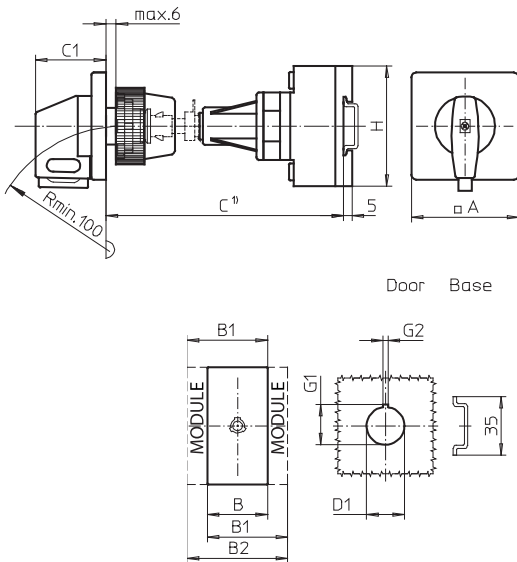

Door interlock with metal shaft extension:
Single hole front mounting

Types H216 / H220 / H226 / H233:

Mtg. form	A	B	B1	B2	C1	D1	G1	G2	H
285M1	64	72	84	96	39	22.5	24.2	3.2	70
285V1	64	72	84	96	39	22.5	24.2	3.2	70
291V1	64	72	84	96	39	22.5	24.2	3.2	70

Types B240 / B250 / B263:

Mtg. form	A	B	B1	B2	C1	D1	G1	G2	H
285M1	64	100	119	138	39	22.5	24.2	3.2	72
285V1	64	100	119	138	39	22.5	24.2	3.2	72
291V1	64	100	119	138	39	22.5	24.2	3.2	72

Types H406 / H408 / H410 / H412:

Mtg. form	A	B	B1	B2	C1	D1	G1	G2	H
283V1	64	140	159	178	39	22.5	24.2	3.2	80
293V1	64	140	159	178	39	22.5	24.2	3.2	80
283M1	64	140	159	178	39	22.5	24.2	3.2	80

¹⁾ Internal depth: outside of door to top of DIN rail, dimensions see page 146.







Disconnect Switches

Changeover Switches **Base mounting** Four hole mounting with door interlock

Changeover Switches

- Base mounting switches with four hole mounting and door interlock
- 3 up to 4 pole
- 160 A up to 315 A
- IP55



Switching programme	Rated data (IEC 60947)			Mounting dimension (base/front) (mm)	G-handle silver/black	Padlock device H-handle silver/black	Padlock device H-handle silver/black
	Operat. current I_e	Operational power (at 380–440 V)			IP55	OFF position padlockable	all positions padlockable
	AC-21A (A)	AC-23A (kW)	AC-3 (kW)		 	 	 
					Order code number	Order code number	Order code number
71300 – 3 pole – without auxiliary contacts	160	75	45	68 × 68 / 68 × 68	K616-71300-042G1	K616-71300-042H1	K616-71300-043H1
	315	132	55	104 × 104 / 104 × 104	K830-71300-042G1	K830-71300-042H1	K830-71300-043H1

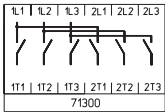

71500 – 4 pole – without auxiliary contacts – neutral contact early make/late break – neutral jumper	160	75	45	68 × 68 / 68 × 68	K616-71500-042G1	K616-71500-042H1	K616-71500-043H1
	315	132	55	104 × 104 / 104 × 104	K830-71500-042G1	K830-71500-042H1	K830-71500-043H1

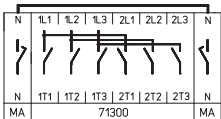

Dimensions in mm:

Setup of order code number		
Type	Switching progr.	Mtg. form
K830	71300	042G1
Order code no.	K830-71300-042G1	

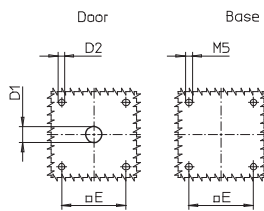
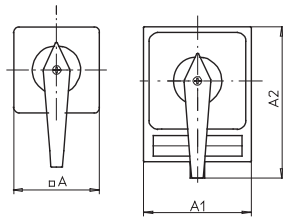
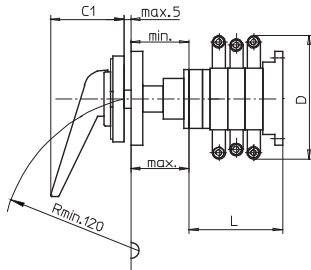

Type K616:

Mtg. form	Switching progr.	A	A1	A2	C1	D*	D1	D2	E	min	max	L
042G1	71300	88	-	-	66	150	15	5.5	68	48	60	136
042G1	71500	88	-	-	66	150	15	5.5	68	48	60	168
042H1	71300	-	98	142	83	150	15	5.5	68	48	60	136
042H1	71500	-	98	142	83	150	15	5.5	68	48	60	168
043H1	71300	-	98	142	83	150	15	5.5	68	48	60	136
043H1	71500	-	98	142	83	150	15	5.5	68	48	60	168

Type K830:

Mtg. form	Switching progr.	A	A1	A2	C1	D*	D1	D2	E	min	max	L
042G1	71300	130	-	-	74	210	20	5.5	104	75	102	161
042G1	71500	130	-	-	74	210	20	5.5	104	75	102	197
042H1	71300	-	130	176	93	210	20	5.5	104	75	102	161
042H1	71500	-	130	176	93	210	20	5.5	104	75	102	197
043H1	71300	-	130	176	93	210	20	5.5	104	75	102	161
043H1	71500	-	130	176	93	210	20	5.5	104	75	102	197

* terminal lugs included

Further switching programmes and corresponding dimensions for types K on request.

Disconnect Switches

Changeover Switches Enclosed Switches – Insulated Enclosure

Changeover Switches

- Enclosed switches with insulated enclosure (polycarbonate)
- Cover interlock in position 1 and 2
- 3 up to 4 pole
- 20 A up to 315 A
- IP66



Switching programme	Rated data (IEC 60947)			Enclosure dimension (H × W × D) (mm)	M-handle silver/black	Padlockable handle V-handle silver/black	Padlockable handle V-handle silver/black
	Operat. current I _e (A)	Operational power (at 380–440 V) (kW)			IP66	OFF position padlockable IP66	all positions padlockable IP66
	AC-21A	AC-23A	AC-3		Order code number	Order code number	Order code number
71300 – 3 pole – without auxiliary contacts 	20	5.5	3.7	250 × 160 × 120	H216-71300-732M1	H216-71300-732V1	H216-71300-728V1
	20	5.5	3.7	280 × 190 × 130	H216-71300-772M1	H216-71300-772V1	H216-71300-773V1
	25	7.5	5.5	250 × 160 × 120	H220-71300-732M1	H220-71300-732V1	H220-71300-728V1
	25	7.5	5.5	280 × 190 × 130	H220-71300-772M1	H220-71300-772V1	H220-71300-773V1
	32	11	7.5	250 × 160 × 120	H226-71300-732M1	H226-71300-732V1	H226-71300-728V1
	32	11	7.5	280 × 190 × 130	H226-71300-772M1	H226-71300-772V1	H226-71300-773V1
	40	15	11	250 × 160 × 120	H233-71300-732M1	H233-71300-732V1	H233-71300-728V1
	40	15	11	280 × 190 × 130	H233-71300-772M1	H233-71300-772V1	H233-71300-773V1
	40	15	11	280 × 190 × 130	B240-71300-772M1*¹	B240-71300-772V1*¹	B240-71300-773V1*¹
	40	15	11	320 × 220 × 180	B240-71300-978M1	–	–
	50	18.5	15	280 × 190 × 130	B250-71300-772M1¹	B250-71300-772V1¹	B250-71300-773V1¹
	50	18.5	15	320 × 220 × 180	B250-71300-978M1	–	–
	63	22	18.5	280 × 190 × 130	B263-71300-772M1¹	B263-71300-772V1¹	B263-71300-773V1¹
	63	22	18.5	320 × 220 × 180	B263-71300-978M1	–	–
	63	22	18.5	320 × 220 × 180	H406-71300-976M1*	–	–
	63	22	18.5	440 × 320 × 180	H406-71300-576M1	–	–
	80	30	22	320 × 220 × 180	H408-71300-976M1	–	–
	80	30	22	440 × 320 × 180	H408-71300-576M1	–	–
	100	37	30	320 × 220 × 180	H410-71300-976M1	–	–
	100	37	30	440 × 320 × 180	H410-71300-576M1	–	–
125	45	37	320 × 220 × 180	H412-71300-976M1	–	–	
125	45	37	440 × 320 × 180	H412-71300-576M1	–	–	

* larger terminal capacity, see page 154



¹ Terminal capacity max. 16 mm² on N-terminal and/or PE-terminal

Further switching programmes from page 132.

Disconnect Switches

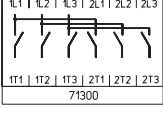

Changeover Switches Enclosed Switches – Insulated Enclosure

Switching programme	Rated data (IEC 60947)			Enclosure dimension (H × W × D) (mm)	Padlock device H-handle silver/black	Padlock device H-handle silver/black
	Operat. current I _e	Operational power (at 380–440 V)			 OFF position padlockable IP66	 all positions padlockable IP66
	AC-21A (A)	AC-23A (kW)	AC-3 (kW)		Order code number	Order code number
71300 – 3 pole – without auxiliary contacts 	40	15	11	320 × 220 × 180	B240-71300-976H1	B240-71300-979H1
	50	18.5	15	320 × 220 × 180	B250-71300-976H1	B250-71300-979H1
	63	22	18.5	320 × 220 × 180	B263-71300-976H1	B263-71300-979H1
	63	22	18.5	320 × 220 × 180	H406-71300-976H1*	H406-71300-979H1*
	63	22	18.5	440 × 320 × 180	H406-71300-576H1	H406-71300-579H1
	80	30	22	320 × 220 × 180	H408-71300-976H1	H408-71300-979H1
	80	30	22	440 × 320 × 180	H408-71300-576H1	H408-71300-579H1
	100	37	30	320 × 220 × 180	H410-71300-976H1	H410-71300-979H1
	100	37	30	440 × 320 × 180	H410-71300-576H1	H410-71300-579H1
	125	45	37	320 × 220 × 180	H412-71300-976H1	H412-71300-979H1
	125	45	37	440 × 320 × 180	H412-71300-576H1	H412-71300-579H1
	160	75	45	440 × 320 × 255	K616-71300-176H1	–
	315	132	55	640 × 320 × 330	K830-71300-176H1	–

Switching programme	Rated data (IEC 60947)			Enclosure dimension (H × W × D) (mm)	M-handle silver/black	Padlockable handle V-handle silver/black	Padlockable handle V-handle silver/black
	Operat. current I _e	Operational power (at 380–440 V)			 IP66	 OFF position padlockable IP66	 all positions padlockable IP66
	AC-21A (A)	AC-23A (kW)	AC-3 (kW)		Order code number	Order code number	Order code number
71500 – 4 pole – without auxiliary contacts – neutral contact – early make/late break – neutral link 	20	5.5	3.7	250 × 160 × 120	H216-71500-732M1	H216-71500-732V1	H216-71500-728V1
	20	5.5	3.7	280 × 190 × 130	H216-71500-772M1	H216-71500-772V1	H216-71500-773V1
	25	7.5	5.5	250 × 160 × 120	H220-71500-732M1	H220-71500-732V1	H220-71500-728V1
	25	7.5	5.5	280 × 190 × 130	H220-71500-772M1	H220-71500-772V1	H220-71500-773V1
	32	11	7.5	250 × 160 × 120	H226-71500-732M1	H226-71500-732V1	H226-71500-728V1
	32	11	7.5	280 × 190 × 130	H226-71500-772M1	H226-71500-772V1	H226-71500-773V1
	40	15	11	250 × 160 × 120	H233-71500-732M1	H233-71500-732V1	H233-71500-728V1
	40	15	11	280 × 190 × 130	H233-71500-772M1	H233-71500-772V1	H233-71500-773V1
	40	15	11	280 × 190 × 130	B240-71500-772M1*¹	B240-71500-772V1*¹	B240-71500-773V1*¹
	40	15	11	320 × 220 × 180	B240-71500-978M1	–	–
	50	18.5	15	280 × 190 × 130	B250-71500-772M1¹	B250-71500-772V1¹	B250-71500-773V1¹
	50	18.5	15	320 × 220 × 180	B250-71500-978M1	–	–
	63	22	18.5	280 × 190 × 130	B263-71500-772M1¹	B263-71500-772V1¹	B263-71500-773V1¹
	63	22	18.5	320 × 220 × 180	B263-71500-978M1	–	–
	63	22	18.5	320 × 220 × 180	H406-71500-976M1*	–	–
	63	22	18.5	440 × 320 × 180	H406-71500-576M1	–	–
	80	30	22	320 × 220 × 180	H408-71500-976M1	–	–
	80	30	22	440 × 320 × 180	H408-71500-576M1	–	–
	100	37	30	320 × 220 × 180	H410-71500-976M1	–	–
	100	37	30	440 × 320 × 180	H410-71500-576M1	–	–
	125	45	37	320 × 220 × 180	H412-71500-976M1	–	–
	125	45	37	440 × 320 × 180	H412-71500-576M1	–	–



* larger terminal capacity, see page 154

¹ Terminal capacity max. 16 mm² on N-terminal and/or PE-terminal

Further switching programmes from page 132.

Disconnect Switches

Changeover Switches Enclosed Switches – Insulated Enclosure

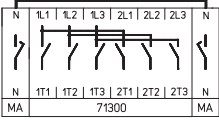
Switching programme	Rated data (IEC 60947)			Enclosure dimension (H × W × D) (mm)	Padlock device H-handle silver/black	Padlock device H-handle silver/black
	Operat. current I _e	Operational power (at 380–440 V)			 OFF position padlockable IP66	 all positions padlockable IP66
	AC-21A (A)	AC-23A (kW)	AC-3 (kW)		Order code number	Order code number
71500 – 4 pole – without auxiliary contacts – neutral contact early make/late break – neutral link 	40	15	11	320 × 220 × 180	B240-71500-976H1	B240-71500-979H1
	50	18.5	15	320 × 220 × 180	B250-71500-976H1	B250-71500-979H1
	63	22	18.5	320 × 220 × 180	B263-71500-976H1	B263-71500-979H1
	63	22	18.5	320 × 220 × 180	H406-71500-976H1*	H406-71500-979H1*
	63	22	18.5	440 × 320 × 180	H406-71500-576H1	H406-71500-579H1
	80	30	22	320 × 220 × 180	H408-71500-976H1	H408-71500-979H1
	80	30	22	440 × 320 × 180	H408-71500-576H1	H408-71500-579H1
	100	37	30	320 × 220 × 180	H410-71500-976H1	H410-71500-979H1
	100	37	30	440 × 320 × 180	H410-71500-576H1	H410-71500-579H1
	125	45	37	320 × 220 × 180	H412-71500-976H1	H412-71500-979H1
	125	45	37	440 × 320 × 180	H412-71500-576H1	H412-71500-579H1
	160	75	45	440 × 320 × 255	K616-71500-176H1	–
	315	132	55	640 × 320 × 330	K830-71500-176H1	–

* larger terminal capacity, see page 154

Further switching programmes from page 132.

Dimensions in mm:

Setup of order code number		
Type	Switching progr.	Mtg. form
H216	71300	732M1
Order code no. H216-71300-732M1		

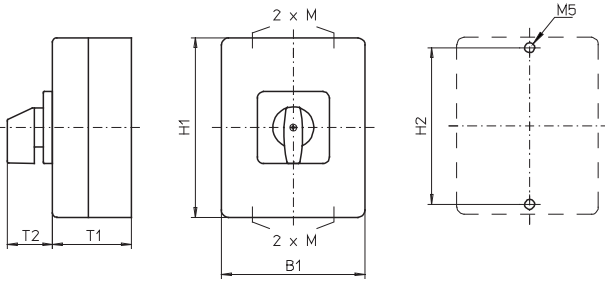

Insulated enclosure **250 × 160 × 120 mm**:

Types H216 / H220 / H226 / H233:

Mtg. form	H1	B1	T1	T2	2×M	H2
728V1	250	160	120	39	32/40	235
732M1	250	160	120	39	32/40	235
732V1	250	160	120	39	32/40	235

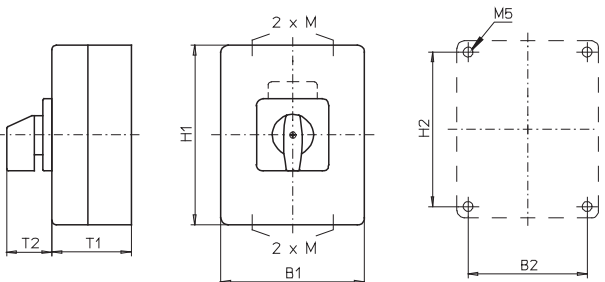

Insulated enclosures **280 × 190 × 130 mm**
and **320 × 220 × 180 mm**:

Types H216 / H220 / H226 / H233 / B240 / B250 / B263 / H406 / H408 / H410 / H412:

Mtg. form	H1	B1	T1	T2	2×M	H2	B2
772M1	280	190	130	39	40×1.5	254	164
772V1	280	190	130	39	40×1.5	254	164
773V1	280	190	130	39	40×1.5	254	164
976M1	320	220	180	52	– ¹	293	193
976H1	320	220	180	83	– ¹	293	193
978M1	320	220	180	52	– ¹	293	193
979H1	320	220	180	83	– ¹	293	193

¹ Blank gland plates

Dimensions in mm:

Setup of order code number		
Type	Switching progr.	Mtg. form
K830	71500	176H1
Order code no.	K830-71500-176H1	

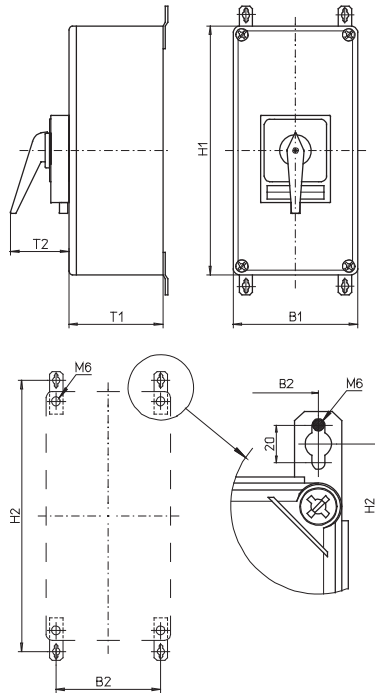

Mounting brackets are included.

Insulated enclosures **440 × 320 × 180 mm / 440 × 320 × 255 mm / 640 × 320 × 330 mm:**

Types H406 / H408 / H410 / H412:

Mtg. form	H1	B1	T1	T2	H2	B2
576H1	440	320	180	83	480	293
576M1	440	320	180	52	480	293
579H1	440	320	180	83	480	293

Type K616:

Mtg. form	H1	B1	T1	T2	H2	B2
176H1	440	320	255	83	480	293

Type K830:

Mtg. form	H1	B1	T1	T2	H2	B2
176H1	640	320	330	93	680	293

Further switching programmes and corresponding dimensions for types K on request.

Blank gland plates

Disconnect Switches

Changeover Switches Enclosed Switches – Insulated Enclosure for EMV/EMC application

Changeover Switches

- Enclosed switches with insulated enclosure (polycarbonate)
- EMV/EMC application, connection system for the uninterrupted connection of shielded/screened cables consisting of shroud and 4 shroud clamps \varnothing 12–16 mm
- Cover interlock in position 1 and 2
- 3 pole
- 20 A up to 40 A
- IP66

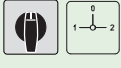
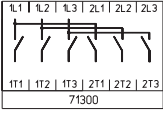

Switching programme	Rated data (IEC 60947)			Enclosure dimension (H x W x D) (mm)	M-handle silver/black
	Operat. current I_e	Operational power (at 380–440 V)			
	AC-21A (A)	AC-23A (kW)	AC-3 (kW)		Order code number
71300 – 3 pole – without auxiliary contacts 	20	5.5	3.7	175 x 115 x 100	H216-71300-727M1
	25	7.5	5.5	175 x 115 x 100	H220-71300-727M1
	32	11	7.5	175 x 115 x 100	H226-71300-727M1
	40	15	11	175 x 115 x 100	H233-71300-727M1

Further switching programmes from page 132.

Dimensions in mm:

Setup of order code number		
Type	Switching progr.	Mtg. form
H216	71300	727M1
Order code no. H216-71300-727M1		

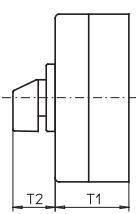
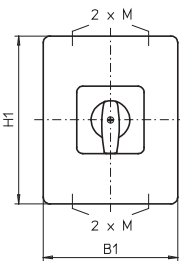
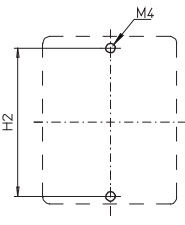
Types H216 / H220 / H226 / H233:

Mtg. form	H1	B1	T1	T2	2xM	H2
727M1	175	115	100	39	20/25	165

Changeover Switches

- Enclosed switches with mild steel enclosure (powder coated – RAL 7035)
- Cover interlock in position 1 and 2
- 3 up to 4 pole
- 20 A up to 315 A
- IP66



Switching programme	Rated data (IEC 60947)			Enclosure dimension (H × W × D) (mm)	M-handle silver/black	Padlockable handle V-handle silver/black	Padlockable handle V-handle silver/black
	Operat. current I _e (A)	Operational power (at 380–440 V) (kW)			IP66	IP66	IP66
	AC-21A	AC-23A	AC-3		Order code number	Order code number	Order code number
71300 – 3 pole – without auxiliary contacts 	20	5.5	3.7	200 × 150 × 120	IP66	OFF position padlockable IP66	all positions padlockable IP66
	25	7.5	5.5	200 × 150 × 120	H216-71300-188M1	H216-71300-186V1	H216-71300-188V1
	32	11	7.5	200 × 150 × 120	H220-71300-188M1	H220-71300-186V1	H220-71300-188V1
	40	15	11	200 × 150 × 120	H226-71300-188M1	H226-71300-186V1	H226-71300-188V1
	40	15	11	300 × 250 × 150	H233-71300-188M1	H233-71300-186V1	H233-71300-188V1
	50	18.5	15	300 × 250 × 150	B240-71300-188M1	B240-71300-186V1	B240-71300-188V1
	50	18.5	15	300 × 250 × 150	B250-71300-188M1	B250-71300-186V1	B250-71300-188V1
	63	22	18.5	300 × 250 × 150	B263-71300-188M1	B263-71300-186V1	B263-71300-188V1
	63	22	18.5	300 × 250 × 150	H406-71300-186M1*	–	–
	63	22	18.5	400 × 300 × 155	H406-71300-181M1¹	–	–
	80	30	22	300 × 250 × 150	H408-71300-186M1	–	–
	80	30	22	400 × 300 × 155	H408-71300-181M1¹	–	–
	100	37	30	300 × 250 × 150	H410-71300-186M1	–	–
	100	37	30	400 × 300 × 155	H410-71300-181M1¹	–	–
125	45	37	300 × 250 × 150	H412-71300-186M1	–	–	
125	45	37	400 × 300 × 155	H412-71300-181M1¹	–	–	

Rated data (IEC 60947)			Enclosure dimension (H × W × D) (mm)	Padlock device H-handle silver/black	Padlock device H-handle silver/black
Operat. current I _e (A)	Operational power (at 380–440 V) (kW)			IP66	IP66
AC-21A	AC-23A	AC-3		Order code number	Order code number
63	22	18.5	300 × 250 × 150	H406-71300-186H1	H406-71300-189H1
63	22	18.5	400 × 300 × 155	H406-71300-183H1¹	–
80	30	22	300 × 250 × 150	H408-71300-186H1	H408-71300-189H1
80	30	22	400 × 300 × 155	H408-71300-183H1¹	–
100	37	30	300 × 250 × 150	H410-71300-186H1	H410-71300-189H1
100	37	30	400 × 300 × 155	H410-71300-183H1¹	–
125	45	37	300 × 250 × 150	H412-71300-186H1	H412-71300-189H1
125	45	37	400 × 300 × 155	H412-71300-183H1¹	–
160	75	45	500 × 400 × 300	K616-71300-186H1¹	–
315	132	55	600 × 400 × 300	K830-71300-186H1¹	–
315	132	55	800 × 400 × 300	K830-71300-286H1¹	–



* larger terminal capacity, see page 154

¹ hinged door



Further switching programmes from page 132.

Disconnect Switches

Changeover Switches Enclosed Switches – Mild Steel Enclosure

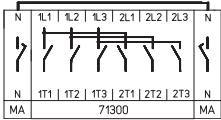
Switching programme	Rated data (IEC 60947)			Enclosure dimension (H × W × D) (mm)	M-handle silver/black	Padlockable handle V-handle silver/black	Padlockable handle V-handle silver/black
	Operat. current I _e	Operational power (at 380–440 V)			 IP66	 OFF position padlockable IP66	 all positions padlockable IP66
	AC-21A (A)	AC-23A (kW)	AC-3 (kW)		Order code number	Order code number	Order code number
71500 – 4 pole – without auxiliary contacts – neutral contact – early make/late break – neutral jumper	20	5.5	3.7	200 × 150 × 120	H216-71500-188M1	H216-71500-186V1	H216-71500-188V1
	25	7.5	5.5	200 × 150 × 120	H220-71500-188M1	H220-71500-186V1	H220-71500-188V1
	32	11	7.5	200 × 150 × 120	H226-71500-188M1	H226-71500-186V1	H226-71500-188V1
	40	15	11	200 × 150 × 120	H233-71500-188M1	H233-71500-186V1	H233-71500-188V1
	40	15	11	300 × 250 × 150	B240-71500-188M1	B240-71500-186V1	B240-71500-188V1
	50	18.5	15	300 × 250 × 150	B250-71500-188M1	B250-71500-186V1	B250-71500-188V1
	63	22	18.5	300 × 250 × 150	B263-71500-188M1	B263-71500-186V1	B263-71500-188V1
	63	22	18.5	300 × 250 × 150	H406-71500-186M1*	–	–
	63	22	18.5	400 × 300 × 155	H406-71500-181M1¹	–	–
	80	30	22	300 × 250 × 150	H408-71500-186M1	–	–
	80	30	22	400 × 300 × 155	H408-71500-181M1¹	–	–
	100	37	30	300 × 250 × 150	H410-71500-186M1	–	–
	100	37	30	400 × 300 × 155	H410-71500-181M1¹	–	–
	125	45	37	300 × 250 × 150	H412-71500-186M1	–	–
125	45	37	400 × 300 × 155	H412-71500-181M1¹	–	–	



Rated data (IEC 60947)			Enclosure dimension (H × W × D) (mm)	Padlock device H-handle silver/black	Padlock device H-handle silver/black	
Operat. current I _e	Operational power (at 380–440 V)			 OFF position padlockable IP66	 all positions padlockable IP66	
AC-21A (A)	AC-23A (kW)	AC-3 (kW)		Order code number	Order code number	
63	22	18.5	300 × 250 × 150	H406-71500-186H1	H406-71500-189H1	
63	22	18.5	400 × 300 × 155	H406-71500-183H1¹	–	
80	30	22	300 × 250 × 150	H408-71500-186H1	H408-71500-189H1	
80	30	22	400 × 300 × 155	H408-71500-183H1¹	–	
100	37	30	300 × 250 × 150	H410-71500-186H1	H410-71500-189H1	
100	37	30	400 × 300 × 155	H410-71500-183H1¹	–	
125	45	37	300 × 250 × 150	H412-71500-186H1	H412-71500-189H1	
125	45	37	400 × 300 × 155	H412-71500-183H1¹	–	
160	75	45	500 × 400 × 300	K616-71500-186H1¹	–	
315	132	55	600 × 400 × 300	K830-71500-186H1¹	–	
315	132	55	800 × 400 × 300	K830-71500-286H1¹	–	

* larger terminal capacity, see page 154

¹ hinged door

Further switching programmes from page 132.

Dimensions in mm:

Setup of order code number		
Type	Switching progr.	Mtg. form
H226	71500	186V1
Order code no. H226-71500-186V1		

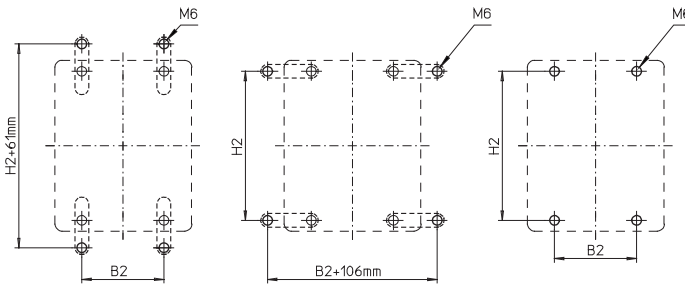
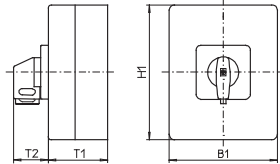

Please order mounting brackets separately, see page 148.

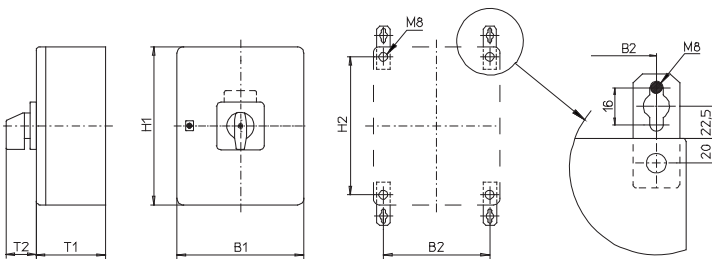

Please order mounting brackets separately, see page 148.

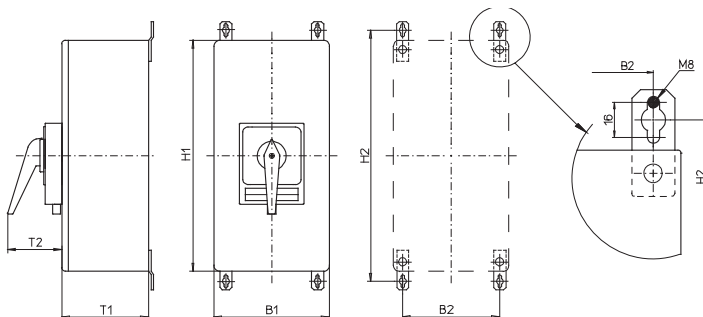

Mounting brackets are included.

Mild steel enclosure **200 × 150 × 120 mm**
and **300 × 250 × 150 mm**:

Types H216 / H220 / H226 / H233:

Mtg. form	H1	B1	T1	T2	H2	B2
186V1	200	150	120	39	182	85
188M1	200	150	120	39	182	85
188V1	200	150	120	39	182	85

Types B240 / B250 / B263:

Mtg. form	H1	B1	T1	T2	H2	B2
186V1	300	250	150	39	282	185
188M1	300	250	150	52	282	185
188V1	300	250	150	39	282	185

Types H406 / H408 / H410 / H412:

Mtg. form	H1	B1	T1	T2	H2	B2
186H1	300	250	150	83	282	185
186M1	300	250	150	52	282	185
189H1	300	250	150	83	282	185

Mild steel enclosure **400 × 300 × 155 mm**:

Types H406 / H408 / H410 / H412:

Mtg. form	H1	B1	T1	T2	H2	B2
181M1	400	300	155	52	360	260
183H1	400	300	155	45	282	185

Gland plate at the bottom

Mild steel enclosure **500 × 400 × 300 mm /**
600 × 400 × 300 mm / 800 × 400 × 300 mm:

Type K616:

Mtg. form	H1	B1	T1	T2	H2	B2
186H1	500	400	300	83	545	360

Type K830:

Mtg. form	H1	B1	T1	T2	H2	B2
186H1	600	400	300	93	645	360
286H1	800	400	300	93	845	360

Further switching programmes and corresponding dimensions for types K on request.

Gland plate at the bottom

Disconnect Switches

Changeover Switches Enclosed Switches – Stainless Steel Enclosure

Changeover Switches

- Enclosed switches with stainless steel enclosure (brushed)
- Cover interlock in position 1 and 2
- 3 up to 4 pole
- 20 A up to 125 A
- IP66



Switching programme	Rated data (IEC 60947)			Enclosure dimension (H × W × D) (mm)	M-handle silver/black	Padlockable handle V-handle silver/black	Padlockable handle V-handle silver/black
	Operat. current I _e (A)	Operational power (at 380–440 V) (kW)			IP66	OFF position padlockable IP66	all positions padlockable IP66
71300 – 3 pole – without auxiliary contacts 	20	5.5	3.7	200 × 150 × 120	IP66	OFF position padlockable IP66	all positions padlockable IP66
	Order code number				Order code number	Order code number	Order code number
	25	7.5	5.5	200 × 150 × 120	H216-71300-198M1	H216-71300-196V1	H216-71300-198V1
	32	11	7.5	200 × 150 × 120	H220-71300-198M1	H220-71300-196V1	H220-71300-198V1
	40	15	11	200 × 150 × 120	H226-71300-198M1	H226-71300-196V1	H226-71300-198V1
	40	15	11	300 × 250 × 150	H233-71300-198M1	H233-71300-196V1	H233-71300-198V1
	50	18.5	15	300 × 250 × 150	B240-71300-198M1	B240-71300-196V1	B240-71300-198V1
	63	22	18.5	300 × 250 × 150	B250-71300-198M1	B250-71300-196V1	B250-71300-198V1
	63	22	18.5	300 × 250 × 150	B263-71300-198M1	B263-71300-196V1	B263-71300-198V1
	80	30	22	300 × 250 × 150	H406-71300-196M1*	–	–
100	37	30	300 × 250 × 150	H408-71300-196M1	–	–	
125	45	37	300 × 250 × 150	H410-71300-196M1	–	–	
				H412-71300-196M1	–	–	
71500 – 4 pole – without auxiliary contacts – neutral contact early make/late break – neutral jumper 	20	5.5	3.7	200 × 150 × 120	H216-71500-198M1	H216-71500-196V1	H216-71500-198V1
	Order code number				Order code number	Order code number	Order code number
	25	7.5	5.5	200 × 150 × 120	H220-71500-198M1	H220-71500-196V1	H220-71500-198V1
	32	11	7.5	200 × 150 × 120	H226-71500-198M1	H226-71500-196V1	H226-71500-198V1
	40	15	11	200 × 150 × 120	H233-71500-198M1	H233-71500-196V1	H233-71500-198V1
	40	15	11	300 × 250 × 150	B240-71500-198M1	B240-71500-196V1	B240-71500-198V1
	50	18.5	15	300 × 250 × 150	B250-71500-198M1	B250-71500-196V1	B250-71500-198V1
	63	22	18.5	300 × 250 × 150	B263-71500-198M1	B263-71500-196V1	B263-71500-198V1
	63	22	18.5	300 × 250 × 150	H406-71500-196M1*	–	–
	80	30	22	300 × 250 × 150	H408-71500-196M1	–	–
100	37	30	300 × 250 × 150	H410-71500-196M1	–	–	
125	45	37	300 × 250 × 150	H412-71500-196M1	–	–	

* larger terminal capacity, see page 154

Further switching programmes from page 132.

Dimensions in mm:

Setup of order code number

Type	Switching progr.	Mtg. form
B263	71300	198V1
Order code no. B263-71300-198V1		

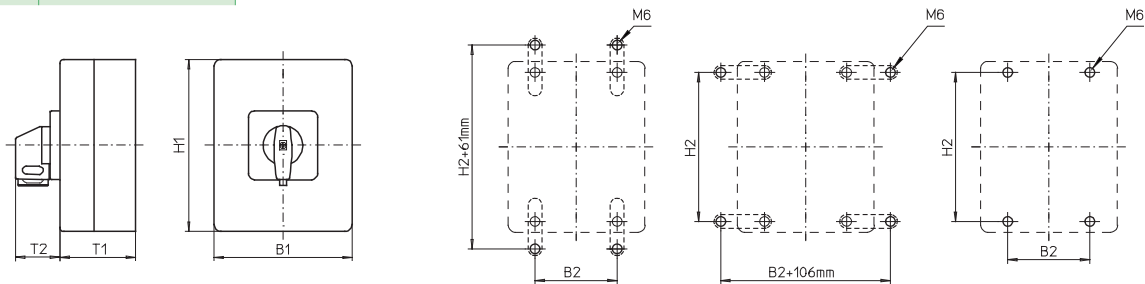

Please order mounting brackets separately, see page 148.

Types H216 / H220 / H226 / H233:

Mtg. form	H1	B1	T1	T2	H2	B2
196V1	200	150	120	39	182	85
198M1	200	150	120	39	182	85
198V1	200	150	120	39	182	85

Types H406 / H408 / H410 / H412:

Mtg. form	H1	B1	T1	T2	H2	B2
196M1	300	250	150	52	282	185
196V1	300	250	150	39	282	185
198V1	300	250	150	39	282	185

Types B240 / B250 / B263:

Mtg. form	H1	B1	T1	T2	H2	B2
196V1	300	250	150	39	282	185
198M1	300	250	150	52	282	185
198V1	300	250	150	39	282	185

Disconnect Switches

Technical Information Switching diagrams

Switching diagrams 41200–41311

Main/Emergency-Off Switches · Main Switches · ON-OFF Switches, 2 pole

	1/L1 3/L2 5/L3
	2/T1 4/T2 6/T3
SMD	41200

Switching programme 41200
2 pole without auxiliary contacts

	1/L1 3/L2 5/L3	21 13
	2/T1 4/T2 6/T3	22 14
SMD	41200	MB

Switching programme 41211
2 pole with 2 auxiliary contacts
1 n/o late make/early break + 1 n/c

	1/L1 3/L2 5/L3	33 43
	2/T1 4/T2 6/T3	34 44
SMD	41200	MD

Switching programme 41220
2 pole with 2 auxiliary contacts
2 n/o late make/early break

	24 32	1/L1 3/L2 5/L3	21 13
	23 31	2/T1 4/T2 6/T3	22 14
SMD	MC	41200	MB

Switching programme 41222
2 pole with 4 auxiliary contacts
2 n/o late make/early break + 2 n/c

	44 34	1/L1 3/L2 5/L3	21 13
	43 33	2/T1 4/T2 6/T3	22 14
SMD	MD	41200	MB

Switching programme 41231
2 pole with 4 auxiliary contacts
3 n/o late make/early break + 1 n/c

	64 54	1/L1 3/L2 5/L3	33 43
	63 53	2/T1 4/T2 6/T3	34 44
SMD	ME	41200	MD

Switching programme 41240
2 pole with 4 auxiliary contacts
4 n/o late make/early break

Main/Emergency-Off Switches · Main Switches · ON-OFF Switches, 3 pole

	1/L1 3/L2 5/L3
	2/T1 4/T2 6/T3
SMD	41300

Switching programme 41300
3 pole without auxiliary contacts

	1/L1 3/L2 5/L3	21 13
	2/T1 4/T2 6/T3	22 14
SMD	41300	MB

Switching programme 41311
3 pole with 2 auxiliary contacts
1 n/o late make/early break + 1 n/c

Switching diagrams 41320–41420

Main/Emergency-Off Switches · Main Switches · ON-OFF Switches, 3 pole

41320	1/L1 3/L2 5/L3	33	43
SMD	41300	MD	

Switching programme 41320
3 pole with 2 auxiliary contacts
2 n/o late make/early break

41322	24	32	1/L1 3/L2 5/L3	21	13
SMD	MC	41300	MB		

Switching programme 41322
3 pole with 4 auxiliary contacts
2 n/o late make/early break + 2 n/c

41331	44	34	1/L1 3/L2 5/L3	21	13
SMD	MD	41300	MB		

Switching programme 41331
3 pole with 4 auxiliary contacts
3 n/o late make/early break + 1 n/c

41340	64	54	1/L1 3/L2 5/L3	33	43
SMD	ME	41300	MD		

Switching programme 41340
3 pole with 4 auxiliary contacts
4 n/o late make/early break

Main/Emergency-Off Switches · Main Switches · ON-OFF Switches, 4 pole

41400	1/L1 3/L2 5/L3	N
SMD	41300	MA

Switching programme 41400
4 pole without auxiliary contacts
Neutral contact early make/late break

41411	14	22	1/L1 3/L2 5/L3	N
SMD	MB	41300	MA	

Switching programme 41411
4 pole with 2 auxiliary contacts
1 n/o late make/early break + 1 n/c
Neutral contact early make/late break

41420	44	34	1/L1 3/L2 5/L3	N
SMD	MD	41300	MA	

Switching programme 41420
4 pole with 2 auxiliary contacts
2 n/o late make/early break
Neutral contact early make/late break

Disconnect Switches

Technical Information Switching diagrams

Switching diagrams 41600–41800

Main/Emergency-Off Switches · Main Switches · ON-OFF Switches, 6 pole

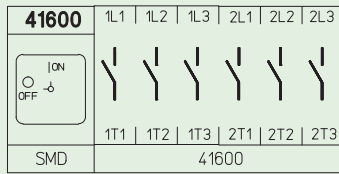

Switching programme 41600
6 pole without auxiliary contacts

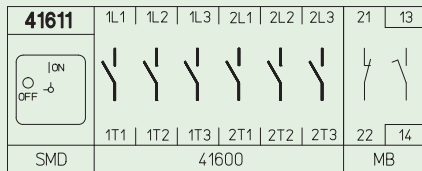

Switching programme 41611
6 pole with 2 auxiliary contacts
1 n/o late make/early break + 1 n/c

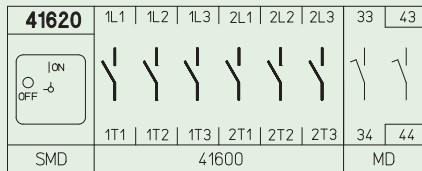

Switching programme 41620
6 pole with 2 auxiliary contacts
2 n/o late make/early break

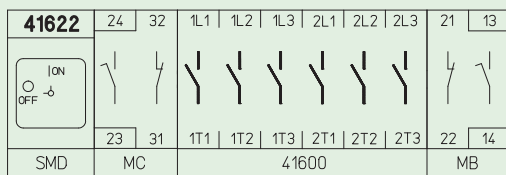

Switching programme 41622
6 pole with 4 auxiliary contacts
2 n/o late make/early break + 2 n/c

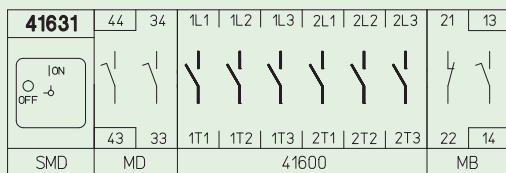

Switching programme 41631
6 pole with 4 auxiliary contacts
3 n/o late make/early break + 1 n/c

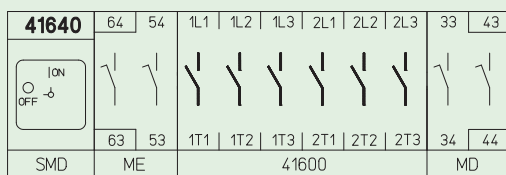

Switching programme 41640
6 pole with 4 auxiliary contacts
4 n/o late make/early break

ON-OFF Switches, 8 pole

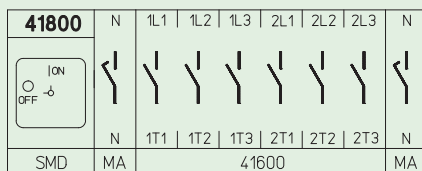

Switching programme 41800
8 pole without auxiliary contacts
2 neutral contacts early make/late break

Switching diagrams 42400–42800

Main/Emergency-Off Switches · Main Switches · ON-OFF Switches, with main contact module

42400	1/L1 3/L2 5/L3 7	
	2/T1 4/T2 6/T3 8	
SMD	41300	MO

Switching programme 42400
4 pole without auxiliary contacts

42411	14 22	1/L1 3/L2 5/L3 7	
	13 21	2/T1 4/T2 6/T3 8	
SMD	MB	41300	MO

Switching programme 42411
4 pole with 2 auxiliary contacts
1 n/o late make/early break + 1 n/c

42420	44 34	1/L1 3/L2 5/L3 7	
	43 33	2/T1 4/T2 6/T3 8	
SMD	MD	41300	MO

Switching programme 42420
4 pole with 2 auxiliary contacts
2 n/o late make/early break

42500	9	1/L1 3/L2 5/L3 7	
	0	2/T1 4/T2 6/T3 8	
SMD	MP	41300	MO

Switching programme 42500
5 pole without auxiliary contacts

42700	1/L1 1/L2 1/L3 2/L1 2/L2 2/L3 7	
	1T1 1T2 1T3 2T1 2T2 2T3 8	
SMD	41600	MO

Switching programme 42700
7 pole without auxiliary contacts

42711	14 22	1/L1 1/L2 1/L3 2/L1 2/L2 2/L3 7	
	13 21	1T1 1T2 1T3 2T1 2T2 2T3 8	
SMD	MB	41600	MO

Switching programme 42711
7 pole with 2 auxiliary contacts
1 n/o late make/early break + 1 n/c

42720	44 34	1/L1 1/L2 1/L3 2/L1 2/L2 2/L3 7	
	43 33	1T1 1T2 1T3 2T1 2T2 2T3 8	
SMD	MD	41600	MO

Switching programme 42720
7 pole with 2 auxiliary contacts
2 n/o late make/early break

42800	9	1/L1 1/L2 1/L3 2/L1 2/L2 2/L3 7	
	0	1T1 1T2 1T3 2T1 2T2 2T3 8	
SMD	MP	41600	MO

Switching programme 42800
8 pole without auxiliary contacts

Disconnect Switches

Technical Information Switching diagrams

Switching diagrams 45300–47200

Main/Emergency-Off Switches · Main Switches · ON-OFF Switches, with N and PE-terminal

45300	PE	1/L1 3/L2 5/L3	N
	PE	2/T1 4/T2 6/T3	N
SMD	MG	41300	MF

Switching programme 45300
3 pole without auxiliary contacts
with N and PE-terminal

45311	PE	N	1/L1 3/L2 5/L3	21	13
	PE	N	2/T1 4/T2 6/T3	22	14
SMD	MG	MF	41300	MB	

Switching programme 45311
3 pole with 2 auxiliary contacts
1 n/o late make/early break + 1 n/c
with N and PE-terminal

45320	PE	N	1/L1 3/L2 5/L3	33	43
	PE	N	2/T1 4/T2 6/T3	34	44
SMD	MG	MF	41300	MD	

Switching programme 45320
3 pole with 2 auxiliary contacts
2 n/o late make/early break
with N and PE-terminal

Main/Emergency-Off Switches · Main Switches · ON-OFF Switches, with N-terminal

46300	1/L1 3/L2 5/L3	N
	2/T1 4/T2 6/T3	N
SMD	41300	MF

Switching programme 46300
3 pole without auxiliary contacts
with N-terminal

46311	14	22	1/L1 3/L2 5/L3	N
	13	21	2/T1 4/T2 6/T3	N
SMD	MB		41300	MF

Switching programme 46311
3 pole with 2 auxiliary contacts
1 n/o late make/early break + 1 n/c
with N-terminal

46320	44	34	1/L1 3/L2 5/L3	N
	43	33	2/T1 4/T2 6/T3	N
SMD	MD		41300	MF

Switching programme 46320
3 pole with 2 auxiliary contacts
2 n/o late make/early break
with N-terminal

Main/Emergency-Off Switches · Main Switches · ON-OFF Switches, with PE-terminal

47200	1/L1 3/L2 5/L3	PE
	2/T1 4/T2 6/T3	PE
SMD	41200	MG

Switching programme 47200
2 pole without auxiliary contacts
with PE-terminal

Switching diagrams 47211–71200

Main/Emergency-Off Switches · Main Switches · ON-OFF Switches, with PE-terminal

47211	14	22	1/L1	3/L2	5/L3	PE
SMD	MB		41200			MG

Switching programme 47211
 2 pole with 2 auxiliary contacts
 1 n/o late make/early break + 1 n/c
 with PE-terminal

47220	44	34	1/L1	3/L2	5/L3	PE
SMD	MD		41200			MG

Switching programme 47220
 2 pole with 2 auxiliary contacts
 2 n/o late make/early break
 with PE-terminal

47300	1/L1	3/L2	5/L3	PE
SMD	41300			MG

Switching programme 47300
 3 pole without auxiliary contacts
 with PE-terminal

47311	14	22	1/L1	3/L2	5/L3	PE
SMD	MB		41300			MG

Switching programme 47311
 3 pole with 2 auxiliary contacts
 1 n/o late make/early break + 1 n/c
 with PE-terminal

47320	44	34	1/L1	3/L2	5/L3	PE
SMD	MD		41300			MG

Switching programme 47320
 3 pole with 2 auxiliary contacts
 2 n/o late make/early break
 with PE-terminal

47400	N	1/L1	3/L2	5/L3	PE
SMD	MA	41300			MG

Switching programme 47400
 4 pole without auxiliary contacts
 Neutral contact early make/late break
 with PE-terminal

48400	9	1/L1	3/L2	5/L3	PE
SMD	MP	41300			MG

Switching programme 48400
 4 pole without auxiliary contacts
 with PE-terminal

Changeover Switches, 2 pole

71200	1/L1	1/L2	1/L3	2/L1	2/L2	2/L3
SMD	71200					

Switching programme 71200
 2 pole without auxiliary contacts

Disconnect Switches

Technical Information Switching diagrams

Switching diagrams 71201–71222

Changeover Switches, 2 pole

71201	1L1 1L2 1L3 2L1 2L2 2L3	21 13		Stellung/Position
	1T1 1T2 1T3 2T1 2T2 2T3	22 14		
SMD	71200	MB	2	

Switching programme 71201
 2 pole with 2 auxiliary contacts
 1 n/o late make/early break + 1 n/c in position 2

71202	1L1 1L2 1L3 2L1 2L2 2L3	33 43		Stellung/Position
	1T1 1T2 1T3 2T1 2T2 2T3	34 44		
SMD	71200	MD	2	

Switching programme 71202
 2 pole with 2 auxiliary contacts
 2 n/o late make/early break in position 2

71210	14 22	1L1 1L2 1L3 2L1 2L2 2L3		Stellung/Position
	13 21	1T1 1T2 1T3 2T1 2T2 2T3		
SMD	1 MB	71200		

Switching programme 71210
 2 pole with 2 auxiliary contacts
 1 n/o late make/early break + 1 n/c in position 1

71211	14 22	1L1 1L2 1L3 2L1 2L2 2L3	31 23		Stellung/Position
	13 21	1T1 1T2 1T3 2T1 2T2 2T3	32 24		
SMD	1 MB	71200	MC	2	

Switching programme 71211
 2 pole with 4 auxiliary contacts
 1 n/o late make/early break + 1 n/c in position 1
 1 n/o late make/early break + 1 n/c in position 2

71212	14 22	1L1 1L2 1L3 2L1 2L2 2L3	33 43		Stellung/Position
	13 21	1T1 1T2 1T3 2T1 2T2 2T3	34 44		
SMD	1 MB	71200	MD	2	

Switching programme 71212
 2 pole with 4 auxiliary contacts
 1 n/o late make/early break + 1 n/c in position 1
 2 n/o late make/early break in position 2

71220	44 34	1L1 1L2 1L3 2L1 2L2 2L3		Stellung/Position
	43 33	1T1 1T2 1T3 2T1 2T2 2T3		
SMD	1 MD	71200		

Switching programme 71220
 2 pole with 2 auxiliary contacts
 2 n/o late make/early break in position 1

71221	44 34	1L1 1L2 1L3 2L1 2L2 2L3	21 13		Stellung/Position
	43 33	1T1 1T2 1T3 2T1 2T2 2T3	22 14		
SMD	1 MD	71200	MB	2	

Switching programme 71221
 2 pole with 4 auxiliary contacts
 2 n/o late make/early break in position 1
 1 n/o late make/early break + 1 n/c in position 2

71222	44 34	1L1 1L2 1L3 2L1 2L2 2L3	53 63		Stellung/Position
	43 33	1T1 1T2 1T3 2T1 2T2 2T3	54 64		
SMD	1 MD	71200	ME	2	

Switching programme 71222
 2 pole with 4 auxiliary contacts
 2 n/o late make/early break in position 1
 2 n/o late make/early break in position 2

Switching diagrams 71300–71321

Changeover Switches, 3 pole

71300	1L1 1L2 1L3 2L1 2L2 2L3	
	1T1 1T2 1T3 2T1 2T2 2T3	
SMD	71300	

Switching programme 71300
3 pole without auxiliary contacts

71301	1L1 1L2 1L3 2L1 2L2 2L3		21 13	Stellung/Position
	1T1 1T2 1T3 2T1 2T2 2T3		22 14	
SMD	71300		MB	2

Switching programme 71301
3 pole with 2 auxiliary contacts
1 n/o late make/early break + 1 n/c in position 2

71302	1L1 1L2 1L3 2L1 2L2 2L3		33 43	Stellung/Position
	1T1 1T2 1T3 2T1 2T2 2T3		34 44	
SMD	71300		MD	2

Switching programme 71302
3 pole with 2 auxiliary contacts
2 n/o late make/early break in position 2

71310	14 22	1L1 1L2 1L3 2L1 2L2 2L3	Stellung/Position	
	13 21	1T1 1T2 1T3 2T1 2T2 2T3		
SMD	1	MB	71300	

Switching programme 71310
3 pole with 2 auxiliary contacts
1 n/o late make/early break + 1 n/c in position 1

71311	14 22	1L1 1L2 1L3 2L1 2L2 2L3	31 23	Stellung/Position		
	13 21	1T1 1T2 1T3 2T1 2T2 2T3	32 24			
SMD	1	MB	71300		MC	2

Switching programme 71311
3 pole with 4 auxiliary contacts
1 n/o late make/early break + 1 n/c in position 1
1 n/o late make/early break + 1 n/c in position 2

71312	14 22	1L1 1L2 1L3 2L1 2L2 2L3	33 43	Stellung/Position		
	13 21	1T1 1T2 1T3 2T1 2T2 2T3	34 44			
SMD	1	MB	71300		MD	2

Switching programme 71312
3 pole with 4 auxiliary contacts
1 n/o late make/early break + 1 n/c in position 1
2 n/o late make/early break in position 2

71320	44 34	1L1 1L2 1L3 2L1 2L2 2L3	Stellung/Position	
	43 33	1T1 1T2 1T3 2T1 2T2 2T3		
SMD	1	MD	71300	

Switching programme 71320
3 pole with 2 auxiliary contacts
2 n/o late make/early break in position 1

71321	44 34	1L1 1L2 1L3 2L1 2L2 2L3	21 13	Stellung/Position		
	43 33	1T1 1T2 1T3 2T1 2T2 2T3	22 14			
SMD	1	MD	71300		MB	2

Switching programme 71321
3 pole with 4 auxiliary contacts
2 n/o late make/early break in position 1
1 n/o late make/early break + 1 n/c in position 2

Disconnect Switches

Technical Information Switching diagrams

Switching diagrams 71322–73500

Changeover Switches, 3 pole

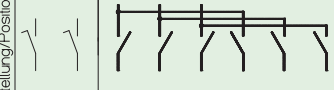
71322 	44	34	1L1	1L2	1L3	2L1	2L2	2L3	53	63	Stellung/Position	
												
SMD	1	MD	71300						ME	2		

Switching programme 71322
 3 pole with 4 auxiliary contacts
 2 n/o late make/early break in position 1
 2 n/o late make/early break in position 2

Changeover Switches, 4 pole

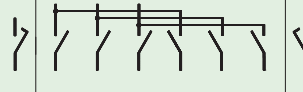
71400 	N	1L1	1L2	1L3	2L1	2L2	2L3	N			
											
SMD	MA	71300						MA			

Switching programme 71400
 4 pole without auxiliary contacts
 Neutral contact early make/late break

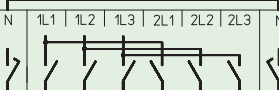
71500 	N	1L1	1L2	1L3	2L1	2L2	2L3	N			
											
SMD	MA	71300						MA			

Switching programme 71500
 4 pole without auxiliary contacts
 Neutral contact early make/late break
 neutral jumper

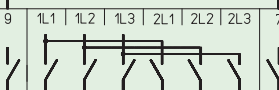
73500 	9	1L1	1L2	1L3	2L1	2L2	2L3	7			
											
SMD	MP	71300						MO			

Switching programme 73500
 4 pole without auxiliary contacts
 neutral jumper main contact modules

Changeover Switches, 3 and 4 pole

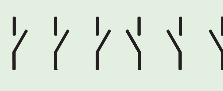
72300 	1L1	1L2	1L3	2L1	2L2	2L3					
											
SMD	72300										

Switching programme 72300
 3 pole without auxiliary contacts
 without jumpers

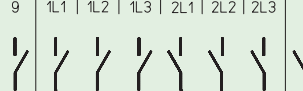
72400 	9	1L1	1L2	1L3	2L1	2L2	2L3	7			
											
SMD	MP	72300						MO			

Switching programme 72400
 4 pole without auxiliary contacts
 without jumpers

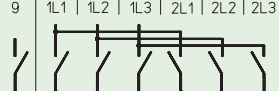
73400 	9	1L1	1L2	1L3	2L1	2L2	2L3	7			
											
SMD	MP	71300						MO			

Switching programme 73400
 3 pole without auxiliary contacts
 without neutral jumper main contact modules

Additional modules for later attachment to switches 41300/41600/71300

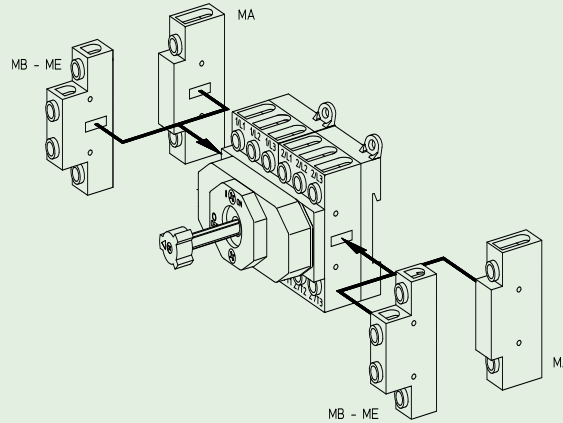

Switching programme		Type	Order code no.	
module left	module right		front mounting	base mounting
Neutral contact module MA early make/late break				
		H216	MAH2-16A01	MAH2-16A02
		H220	MAH2-20A01	MAH2-20A02
		H226	MAH2-26A01	MAH2-26A02
		H233	MAH2-33A01	MAH2-33A02
		B240	MAB2-40A01	MAB2-40A02
		B250	MAB2-50A01	MAB2-50A02
		B263	MAB2-63A01	MAB2-63A02
		H406	MAH4-06A01	MAH4-06A02
		H408	MAH4-08A01	MAH4-08A02
		H410	MAH4-10A01	MAH4-10A02
		H412	MAH4-12A01	MAH4-12A02
N-terminal MF				
		H216	MFH2-00A01	MFH2-00A02
		H220	MFH2-00A01	MFH2-00A02
		H226	MFH2-00A01	MFH2-00A02
		H233	MFH2-00A01	MFH2-00A02
		B240	MFB2-00A01	MFB2-00A02
		B250	MFB2-00A01	MFB2-00A02
		B263	MFB2-00A01	MFB2-00A02
		H406	MFH4-00A01	MFH4-00A02
		H408	MFH4-00A01	MFH4-00A02
		H410	MFH4-00A01	MFH4-00A02
		H412	MFH4-00A01	MFH4-00A02
PE-terminal MG				
		H216	MGH2-00A01	MGH2-00A02
		H220	MGH2-00A01	MGH2-00A02
		H226	MGH2-00A01	MGH2-00A02
		H233	MGH2-00A01	MGH2-00A02
		B240	MGB2-00A01	MGB2-00A02
		B250	MGB2-00A01	MGB2-00A02
		B263	MGB2-00A01	MGB2-00A02
		H406	MGH4-00A01	MGH4-00A02
		H408	MGH4-00A01	MGH4-00A02
		H410	MGH4-00A01	MGH4-00A02
		H412	MGH4-00A01	MGH4-00A02
Main contact module MO				
		H216	MOH2-16A01	MOH2-16A02
		H220	MOH2-20A01	MOH2-20A02
		H226	MOH2-26A01	MOH2-26A02
		H233	MOH2-33A01	MOH2-33A02
		B240	MOB2-40A01	MOB2-40A02
		B250	MOB2-50A01	MOB2-50A02
		B263	MOB2-63A01	MOB2-63A02
		H406	MOH4-06A01	MOH4-06A02
		H408	MOH4-08A01	MOH4-08A02
		H410	MOH4-10A01	MOH4-10A02
		H412	MOH4-12A01	MOH4-12A02

Disconnect Switches

Technical Information Additional modules

Additional modules for later attachment to switches 41300/41600/71300

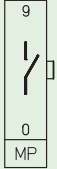
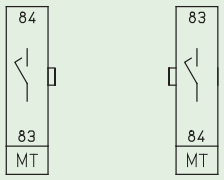
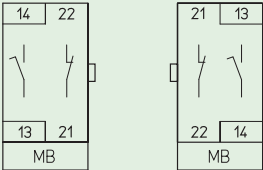
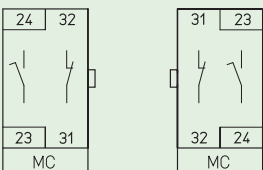
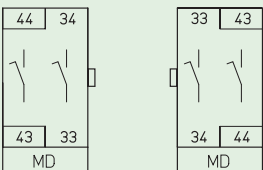
Switching programme		Type	Order code no.			
module left	module right		front mounting	base mounting		
Main contact module MP						
		H216	MPH2-16A01	MPH2-16A02		
		H220	MPH2-20A01	MPH2-20A02		
		H226	MPH2-26A01	MPH2-26A02		
		H233	MPH2-33A01	MPH2-33A02		
		B240	MPB2-40A01	MPB2-40A02		
		B250	MPB2-50A01	MPB2-50A02		
		B263	MPB2-63A01	MPB2-63A02		
		H406	MPH4-06A01	MPH4-06A02		
		H408	MPH4-08A01	MPH4-08A02		
		H410	MPH4-10A01	MPH4-10A02		
		H412	MPH4-12A01	MPH4-12A02		
		Main contact module MT 1 early make/late break 20A				
				H216	MTH2-20A01	MTH2-20A02
H220	MTH2-20A01			MTH2-20A02		
H226	MTH2-20A01			MTH2-20A02		
H233	MTH2-20A01			MTH2-20A02		
B240	MTB2-20A01			MTB2-20A02		
B250	MTB2-20A01			MTB2-20A02		
B263	MTB2-20A01			MTB2-20A02		
H406	MTH4-20A01			MTH4-20A02		
H408	MTH4-20A01			MTH4-20A02		
H410	MTH4-20A01			MTH4-20A02		
H412	MTH4-20A01			MTH4-20A02		
Auxiliary contact module MB 1 n/o late make/early break + 1 n/c						
		H216	MBH2-11A01	MBH2-11A02		
		H220	MBH2-11A01	MBH2-11A02		
		H226	MBH2-11A01	MBH2-11A02		
		H233	MBH2-11A01	MBH2-11A02		
		B240	MBH4-11A01	MBH4-11A02		
		B250	MBH4-11A01	MBH4-11A02		
		B263	MBH4-11A01	MBH4-11A02		
		H406	MBH4-11A01	MBH4-11A02		
		H408	MBH4-11A01	MBH4-11A02		
		H410	MBH4-11A01	MBH4-11A02		
		H412	MBH4-11A01	MBH4-11A02		
Auxiliary contact module MC 1 n/o late make/early break + 1 n/c						
		H216	MCH2-11A01	MCH2-11A02		
		H220	MCH2-11A01	MCH2-11A02		
		H226	MCH2-11A01	MCH2-11A02		
		H233	MCH2-11A01	MCH2-11A02		
		B240	MCH4-11A01	MCH4-11A02		
		B250	MCH4-11A01	MCH4-11A02		
		B263	MCH4-11A01	MCH4-11A02		
		H406	MCH4-11A01	MCH4-11A02		
		H408	MCH4-11A01	MCH4-11A02		
		H410	MCH4-11A01	MCH4-11A02		
		H412	MCH4-11A01	MCH4-11A02		
Auxiliary contact module MD 2 n/o late make/early break						
		H216	MDH2-20A01	MDH2-20A02		
		H220	MDH2-20A01	MDH2-20A02		
		H226	MDH2-20A01	MDH2-20A02		
		H233	MDH2-20A01	MDH2-20A02		
		B240	MDH4-20A01	MDH4-20A02		
		B250	MDH4-20A01	MDH4-20A02		
		B263	MDH4-20A01	MDH4-20A02		
		H406	MDH4-20A01	MDH4-20A02		
		H408	MDH4-20A01	MDH4-20A02		
		H410	MDH4-20A01	MDH4-20A02		
		H412	MDH4-20A01	MDH4-20A02		

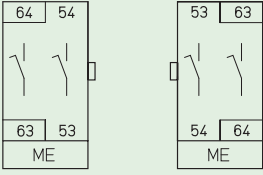
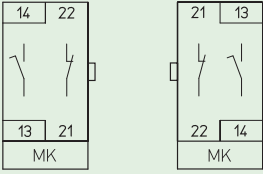
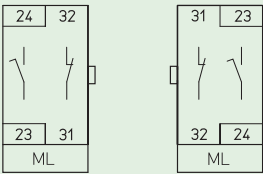
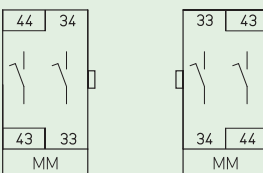
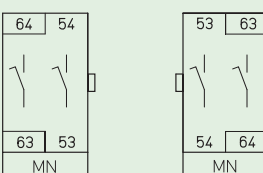

Additional modules for later attachment to switches 41300/41600/71300

Switching programme		Type	Order code no.	
module left	module right		front mounting	base mounting
Auxiliary contact module ME 2 n/o late make/early break 		H216 H220 H226 H233 B240 B250 B263 H406 H408 H410 H412	MEH2-20A01 MEH2-20A01 MEH2-20A01 MEH2-20A01 MEH4-20A01 MEH4-20A01 MEH4-20A01 MEH4-20A01 MEH4-20A01 MEH4-20A01 MEH4-20A01	MEH2-20A02 MEH2-20A02 MEH2-20A02 MEH2-20A02 MEH4-20A02 MEH4-20A02 MEH4-20A02 MEH4-20A02 MEH4-20A02 MEH4-20A02 MEH4-20A02
Auxiliary contact module MK 1 n/o late make/early break + 1 n/c Contacts with gold plating 5 µm 		H216 H220 H226 H233 B240 B250 B263 H406 H408 H410 H412	MKH2-11A01 MKH2-11A01 MKH2-11A01 MKH2-11A01 MKH4-11A01 MKH4-11A01 MKH4-11A01 MKH4-11A01 MKH4-11A01 MKH4-11A01 MKH4-11A01	MKH2-11A02 MKH2-11A02 MKH2-11A02 MKH2-11A02 MKH4-11A02 MKH4-11A02 MKH4-11A02 MKH4-11A02 MKH4-11A02 MKH4-11A02 MKH4-11A02
Auxiliary contact module ML 1 n/o late make/early break + 1 n/c Contacts with gold plating 5 µm 		H216 H220 H226 H233 B240 B250 B263 H406 H408 H410 H412	MLH2-11A01 MLH2-11A01 MLH2-11A01 MLH2-11A01 MLH4-11A01 MLH4-11A01 MLH4-11A01 MLH4-11A01 MLH4-11A01 MLH4-11A01 MLH4-11A01	MLH2-11A02 MLH2-11A02 MLH2-11A02 MLH2-11A02 MLH4-11A02 MLH4-11A02 MLH4-11A02 MLH4-11A02 MLH4-11A02 MLH4-11A02 MLH4-11A02
Auxiliary contact module MM 2 n/o late make/early break Contacts with gold plating 5 µm 		H216 H220 H226 H233 B240 B250 B263 H406 H408 H410 H412	MMH2-20A01 MMH2-20A01 MMH2-20A01 MMH2-20A01 MMH4-20A01 MMH4-20A01 MMH4-20A01 MMH4-20A01 MMH4-20A01 MMH4-20A01 MMH4-20A01	MMH2-20A02 MMH2-20A02 MMH2-20A02 MMH2-20A02 MMH4-20A02 MMH4-20A02 MMH4-20A02 MMH4-20A02 MMH4-20A02 MMH4-20A02 MMH4-20A02
Auxiliary contact module MN 2 n/o late make/early break Contacts with gold plating 5 µm 		H216 H220 H226 H233 B240 B250 B263 H406 H408 H410 H412	MNH2-20A01 MNH2-20A01 MNH2-20A01 MNH2-20A01 MNH4-20A01 MNH4-20A01 MNH4-20A01 MNH4-20A01 MNH4-20A01 MNH4-20A01 MNH4-20A01	MNH2-20A02 MNH2-20A02 MNH2-20A02 MNH2-20A02 MNH4-20A02 MNH4-20A02 MNH4-20A02 MNH4-20A02 MNH4-20A02 MNH4-20A02 MNH4-20A02

Disconnect Switches

Technical Information Additional modules

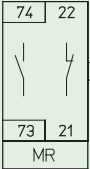
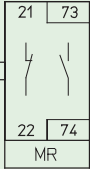
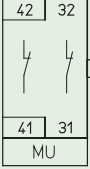
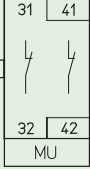
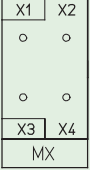
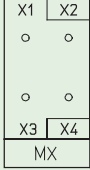
Additional modules for later attachment to switches 41300/41600/71300

Switching programme		Type	Order code no. front mounting	Order code no. base mounting
module left	module right			
Auxiliary contact module MR 1 n/o + 1 n/c		H216	MRH2-11A01	MRH2-11A02
		H220	MRH2-11A01	MRH2-11A02
		H226	MRH2-11A01	MRH2-11A02
		H233	MRH2-11A01	MRH2-11A02
		B240	MRH4-11A01	MRH4-11A02
		B250	MRH4-11A01	MRH4-11A02
		B263	MRH4-11A01	MRH4-11A02
		H406	MRH4-11A01	MRH4-11A02
		H408	MRH4-11A01	MRH4-11A02
		H410	MRH4-11A01	MRH4-11A02
		H412	MRH4-11A01	MRH4-11A02
Auxiliary contact module MU 2 n/c		H216	MUH2-02A01	MUH2-02A02
		H220	MUH2-02A01	MUH2-02A02
		H226	MUH2-02A01	MUH2-02A02
		H233	MUH2-02A01	MUH2-02A02
		B240	MUB2-02A01	MUB2-02A02
		B250	MUB2-02A01	MUB2-02A02
		B263	MUB2-02A01	MUB2-02A02
		H406	MUH4-02A01	MUH4-02A02
		H408	MUH4-02A01	MUH4-02A02
		H410	MUH4-02A01	MUH4-02A02
		H412	MUH4-02A01	MUH4-02A02
Auxiliary connection module MX 4 terminal bases 2,5 mm ²		H216	—	MXH2-04A02
		H220	—	MXH2-04A02
		H226	—	MXH2-04A02
		H233	—	MXH2-04A02
Neutral terminal link (insulated) Link to connect the neutral contact modules (MA) on the 71400 Changeover Switch		H200	224234	224234
		B200	224301	224303
		H400	404111	404111

Additional top escutcheon plates/Shaft extensions

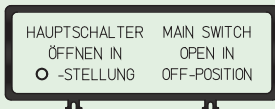

Example: FAZ2-8041

Additional top escutcheon plates

with additional inscription to be clipped on the escutcheon and padlock devices

Order code number

Escutcheon frame plate black, legend plate silver, without inscription (can be engraved)	FAZ2 - 8000
Escutcheon frame plate black, legend plate silver, Inscription black, inscription see "Inscriptions for add. top esc. plates"	FAZ2 - 8...
Escutcheon frame plate black, legend plate silver, Inscription black, special engraving	FAZ2 - (special no.)
Escutcheon frame plate black, legend plate yellow, without inscription (can be engraved)	FBZ2 - 8000
Escutcheon frame plate black, legend plate yellow, Inscription black, inscription see "Inscriptions for add. top esc. plates"	FBZ2 - 8...
Escutcheon frame plate black, legend plate yellow, Inscription black, special engraving	FBZ2 - (special no.)
Escutcheon frame plate black (without legend plate)	FAZ2

Legend plates for additional top escutcheon plates

Legend plate silver without inscription (can be engraved)	FAS2 - 8000
Legend plate silver, Inscription black, inscription see "Inscriptions for additional top escutcheon plates"	FAS2 - 8...
Legend plate silver, Inscription black, special engraving	FAS2 - (special no.)
Legend plate yellow, without inscription (can be engraved)	FBS2 - 8000
Legend plate yellow, Inscription black, inscription see "Inscriptions for additional top escutcheon plates"	FBS2 - 8...
Legend plate yellow, Inscription black, special engraving	FBS2 - (special no.)

Inscriptions for additional top escutcheon plates

	HAUPTSCHALTER	MAIN SWITCH	NETZSCHALTER	NOT-AUS	EMERGENCY OFF	TURVAKYTKIN
FA 8000	FA 8001	FA 8002	FA 8003	FA 8013	FA 8026	FA 8027
HAUPTSCHALTER NUR IN STELLUNG O ÖFFNEN	MAIN SWITCH OPEN ONLY IN POSITION "OFF"	INTERRUPTORE GENERALE ARRR. SOLO CON MANIPOLA SU ZERO	INTERRUPTEUR PRINCIPAL OVRER EN POSITION O SELEMENT	INTERRUPTOR	HOOFDSCHAKEL AAR ALLEN IN O-STAND OPENEN	INTERRUPTOR PRINCIPAL ARRR. SOLO EN POSICION O
FA 8028	FA 8029	FA 8030	FA 8031	FA 8037	FA 8039	FA 8040
HAUPTSCHALTER MAIN SWITCH ÖFFNEN IN OPEN IN O-STELLUNG OFF-POSITION	HUVUDBRYTARE	HLAVNÍ VYPÍNAČ	HLAVNÍ VYPÍNAČ OTEVŘIT POUZE V POLOZE O	ГЛАВНЫЙ ВЫКЛЮЧАТЕЛЬ открывать только в нулевой позиции		
FA 8041	FA 8044	FA 8045	FA 8046	FA 8047		

Modular shaft extensions for mounting forms with door interlock (please order separately!)

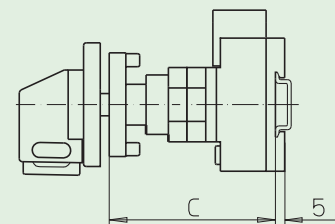
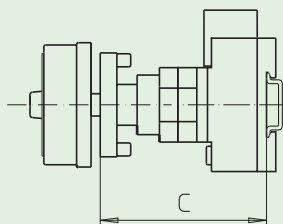
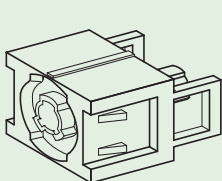

H200 / B200 3...4 pole Main/Emergency-Off Sw. 3...4 pole Main Switches 3...4 pole ON-OFF Switches	H200 / B200 6...8 pole Main/Emergency-Off Sw. 6...8 pole Main Switches 6...8 pole ON-OFF Switches 3...4 pole Changeover Switches	H400 3...4 pole Main/Emergency-Off Sw. 3...4 pole Main Switches 3...4 pole ON-OFF Switches	H400 6...8 pole Main/Emergency-Off Sw. 6...8 pole Main Switches 6...8 pole ON-OFF Switches 3...4 pole Changeover Switches	Order code number
				H200 H400

Dimension C (internal depth: inside of door to top of DIN rail):

092 ... 107 mm	100 ... 115 mm	103 ... 117 mm	116 ... 130 mm	-	-
114 ... 132 mm	122 ... 140 mm	124 ... 142 mm	137 ... 155 mm	AVC2-1	AVC4-1
139 ... 157 mm	147 ... 165 mm	149 ... 167 mm	162 ... 180 mm	AVC2-2	AVC4-2
164 ... 182 mm	172 ... 190 mm	174 ... 192 mm	187 ... 205 mm	AVC2-3	AVC4-3
189 ... 207 mm	197 ... 215 mm	199 ... 217 mm	212 ... 230 mm	AVC2-4	AVC4-4

Disconnect Switches

Technical Information Accessories

Metal shafts

Metal shafts for mounting forms with door interlock (please order separately!)

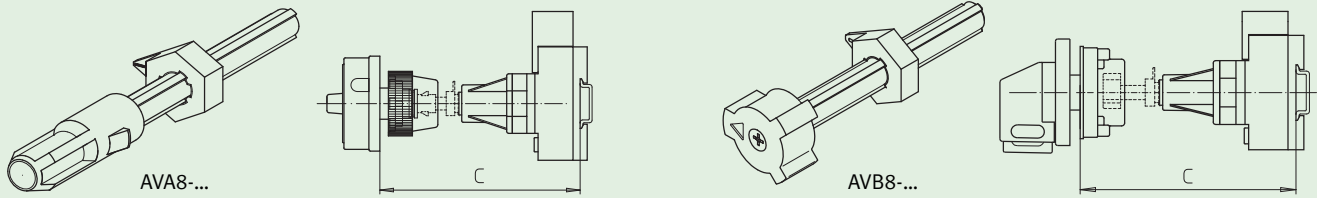

H200/B200	H200	B200	H400	H400	Order code number
3...4 pole Main/Emergency-Off Sw. 3...4 pole Main Switches 3...4 pole ON-OFF Switches	6...8 pole Main/Emergency-Off Sw. 6...8 pole Main Switches 6...8 pole ON-OFF Switches 3...4 pole Changeover Switches	6...8 pole Main/Emergency-Off Sw. 6...8 pole Main Switches 6...8 pole ON-OFF Switches 3...4 pole Changeover Switches	3...4 pole Main/Emergency-Off Sw. 3...4 pole Main Switches 3...4 pole ON-OFF Switches	6...8 pole Main/Emergency-Off Sw. 6...8 pole Main Switches 6...8 pole ON-OFF Switches 3...4 pole Changeover Switches	

Single hole front mounting

Dimension C (internal depth: outside of door to top of DIN rail):

155 ... 173 mm	163 ... 183 mm	167 ... 185 mm	165 ... 183 mm	177 ... 195 mm	AVA8 - 065
174 ... 198 mm	182 ... 206 mm	186 ... 210 mm	184 ... 208 mm	196 ... 220 mm	AVA8 - 090
199 ... 223 mm	207 ... 231 mm	211 ... 235 mm	209 ... 233 mm	221 ... 245 mm	AVA8 - 115
224 ... 248 mm	232 ... 256 mm	236 ... 260 mm	234 ... 258 mm	246 ... 270 mm	AVA8 - 140
249 ... 273 mm	257 ... 281 mm	261 ... 285 mm	259 ... 283 mm	271 ... 295 mm	AVA8 - 165
274 ... 298 mm	282 ... 306 mm	286 ... 310 mm	284 ... 308 mm	296 ... 320 mm	AVA8 - 190
299 ... 323 mm	307 ... 331 mm	311 ... 335 mm	309 ... 333 mm	321 ... 345 mm	AVA8 - 215
324 ... 348 mm	332 ... 356 mm	336 ... 360 mm	334 ... 358 mm	346 ... 370 mm	AVA8 - 240
349 ... 373 mm	357 ... 381 mm	361 ... 385 mm	359 ... 383 mm	371 ... 395 mm	AVA8 - 265
374 ... 398 mm	382 ... 406 mm	386 ... 410 mm	384 ... 408 mm	396 ... 420 mm	AVA8 - 290
399 ... 423 mm	407 ... 431 mm	411 ... 435 mm	409 ... 433 mm	421 ... 445 mm	AVA8 - 315
424 ... 448 mm	432 ... 456 mm	436 ... 460 mm	434 ... 458 mm	446 ... 470 mm	AVA8 - 340
449 ... 473 mm	457 ... 481 mm	461 ... 485 mm	459 ... 483 mm	471 ... 495 mm	AVA8 - 365
474 ... 498 mm	482 ... 506 mm	486 ... 510 mm	484 ... 508 mm	496 ... 520 mm	AVA8 - 390
499 ... 523 mm	507 ... 531 mm	511 ... 535 mm	509 ... 533 mm	521 ... 545 mm	AVA8 - 415
524 ... 548 mm	532 ... 556 mm	536 ... 560 mm	534 ... 558 mm	546 ... 570 mm	AVA8 - 440
549 ... 573 mm	557 ... 581 mm	561 ... 585 mm	559 ... 583 mm	571 ... 595 mm	AVA8 - 465
574 ... 598 mm	582 ... 606 mm	586 ... 610 mm	584 ... 608 mm	596 ... 620 mm	AVA8 - 490
599 ... 623 mm	607 ... 631 mm	611 ... 635 mm	609 ... 633 mm	621 ... 645 mm	AVA8 - 515
624 ... 643 mm	632 ... 656 mm	636 ... 660 mm	634 ... 658 mm	646 ... 670 mm	AVA8 - 540

Four hole front mounting

Dimension C (internal depth: inside of door to top of DIN rail):

140 ... 164 mm	148 ... 172 mm	152 ... 176 mm	150 ... 174 mm	162 ... 186 mm	AVB8 - 065
165 ... 189 mm	173 ... 197 mm	177 ... 201 mm	175 ... 199 mm	187 ... 211 mm	AVB8 - 090
190 ... 214 mm	198 ... 222 mm	202 ... 226 mm	200 ... 224 mm	212 ... 236 mm	AVB8 - 115
215 ... 239 mm	223 ... 247 mm	227 ... 251 mm	225 ... 249 mm	237 ... 261 mm	AVB8 - 140
240 ... 264 mm	248 ... 272 mm	252 ... 276 mm	250 ... 274 mm	262 ... 286 mm	AVB8 - 165
265 ... 289 mm	276 ... 297 mm	277 ... 301 mm	275 ... 299 mm	287 ... 311 mm	AVB8 - 190
290 ... 314 mm	298 ... 322 mm	302 ... 326 mm	300 ... 324 mm	312 ... 336 mm	AVB8 - 215
315 ... 339 mm	323 ... 347 mm	327 ... 351 mm	325 ... 349 mm	337 ... 361 mm	AVB8 - 240
340 ... 364 mm	348 ... 372 mm	352 ... 376 mm	350 ... 374 mm	362 ... 386 mm	AVB8 - 265
365 ... 389 mm	373 ... 397 mm	377 ... 401 mm	375 ... 399 mm	387 ... 411 mm	AVB8 - 290
390 ... 414 mm	398 ... 422 mm	402 ... 426 mm	400 ... 424 mm	412 ... 436 mm	AVB8 - 315
415 ... 439 mm	423 ... 447 mm	427 ... 451 mm	425 ... 449 mm	437 ... 461 mm	AVB8 - 340
440 ... 464 mm	448 ... 472 mm	452 ... 476 mm	450 ... 474 mm	462 ... 486 mm	AVB8 - 365
465 ... 489 mm	473 ... 497 mm	477 ... 501 mm	475 ... 499 mm	487 ... 511 mm	AVB8 - 390
490 ... 514 mm	498 ... 522 mm	502 ... 526 mm	500 ... 524 mm	512 ... 536 mm	AVB8 - 415
515 ... 539 mm	523 ... 547 mm	527 ... 551 mm	525 ... 549 mm	537 ... 561 mm	AVB8 - 440
540 ... 564 mm	548 ... 572 mm	552 ... 576 mm	550 ... 574 mm	562 ... 586 mm	AVB8 - 465
565 ... 589 mm	573 ... 597 mm	577 ... 601 mm	575 ... 599 mm	587 ... 611 mm	AVB8 - 490
590 ... 614 mm	598 ... 622 mm	602 ... 626 mm	600 ... 624 mm	612 ... 636 mm	AVB8 - 515
615 ... 639 mm	625 ... 649 mm	627 ... 651 mm	625 ... 649 mm	637 ... 661 mm	AVB8 - 540

Terminal covers

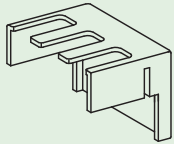

TCA/TCC

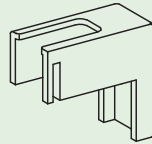

TCB/TCB

Terminal covers can be used on front and base mountings. Incoming terminal covers are included with all Main Switches and Main/Emergency-Off Switches of the H400 product line, and don't have to be ordered separately.

The variety of available switching programmes requires different terminal covers. Please order the required quantities!

H216/H220/H226/H233

Switching programmes	Number	Order code number	Number	Order code number
41200, 41211, 41220, 41222, 41231, 41240	1	TCA2	–	–
41300, 41311, 41320, 41322, 41331, 41340	1	TCA2	–	–
41400, 41411, 41420	1	TCA2	1	TCB2
41600, 41611, 41620, 41622, 41631, 41640	2	TCA2	–	–
41800	2	TCA2	2	TCB2
42400, 42411, 42420	1	TCA2	1	TCB2
42500	1	TCA2	2	TCB2
42700, 42711, 42720	2	TCA2	1	TCB2
42800	2	TCA2	2	TCB2
45300, 45311, 45320, 46300, 46311, 46320	1	TCA2	–	–
47200, 47211, 47220, 47300, 47311, 47320	1	TCA2	–	–
47400, 48400	1	TCA2	1	TCB2

B240/B250/B263

for terminal capacities with max. 16 mm²

Switching programmes	Number	Order code number	Number	Order code number
41200, 41211, 41220, 41222, 41231, 41240	1	TCC2	–	–
41300, 41311, 41320, 41322, 41331, 41340	1	TCC2	–	–
41400, 41411, 41420	1	TCC2	1	TCB2
41600, 41611, 41620, 41622, 41631, 41640	2	TCC2	–	–
41800	2	TCC2	2	TCB2
42400, 42411, 42420	1	TCC2	1	TCB2
42500	1	TCC2	2	TCB2
42700, 42711, 42720	2	TCC2	1	TCB2
42800	2	TCC2	2	TCB2
45300, 45311, 45320, 46300, 46311, 46320	1	TCC2	–	–
47200, 47211, 47220, 47300, 47311, 47320	1	TCC2	–	–
47400, 48400	1	TCC2	1	TCB2

H406/H408/H410/H412

Switching programmes	Number	Order code number	Number	Order code number
41200, 41211, 41220, 41222, 41231, 41240	1	TCA4	–	–
41300, 41311, 41320, 41322, 41331, 41340	1	TCA4	–	–
41400, 41411, 41420	1	TCA4	1	TCB4
41600, 41611, 41620, 41622, 41631, 41640	2	TCA4	–	–
41800	2	TCA4	2	TCB4
42400, 42411, 42420	1	TCA4	1	TCB4
42500	1	TCA4	2	TCB4
42700, 42711, 42720	2	TCA4	1	TCB4
42800	2	TCA4	2	TCB4
45300, 45311, 45320, 46300, 46311, 46320	1	TCA4	–	–
47200, 47211, 47220, 47300, 47311, 47320	1	TCA4	–	–
47400, 48400	1	TCA4	1	TCB4

Disconnect Switches

Technical Information Accessories

Assembly tool/Mounting brackets

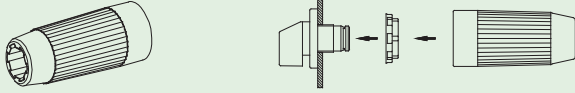

218098

Assembly tool for single hole mounting

suitable for a fast assembly of escutcheons and padlock devices in single hole mounting

Types	Order code number
H216, H220, H226, H233, B240, B250, B263	218098

Mounting brackets for external mounting of enclosures (1 complete set)

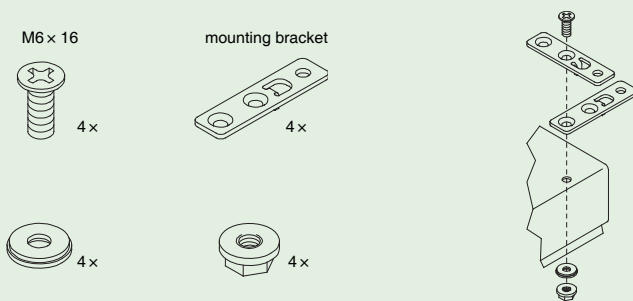

Enclosure	Dimensions	Order code number
Sheet metal enclosure	150 × 150 × 120 mm	SAX1
Sheet metal enclosure	200 × 150 × 120 mm	SAX1
Sheet metal enclosure	300 × 250 × 120 mm	SAX1
Stainless steel enclosure	150 × 150 × 120 mm	SBX1
Stainless steel enclosure	200 × 150 × 120 mm	SBX1
Stainless steel enclosure	300 × 250 × 120 mm	SBX1







Operator variants for mounting forms with padlock device

Operator Suitable for types		Colour escutcheon	Colour legend plate	Colour operator	Change of order code number
N-padlock device H216, H220, H226, H233 B240, B250, B263 H406, H408, H410, H412 K616		black	white	black	... - ... - ...N1
		grey	white	grey	... - ... - ...N2
		yellow	white	red	... - ... - ...N4
		grey	white	black	... - ... - ...N6
		yellow	white	black	... - ... - ...N7
		operator external dimension 67 × 67 mm 88 × 88 mm	max. number of padlocks 3 4	hasp diameter of padlock 4 mm (min) / 8 mm (max) 5 mm (min) / 9 mm (max)	
M-padlock device H216, H220, H226, H233 B240, B250, B263 H406, H408, H410, H412 K616		black	white	black	... - ... - ...M1
		grey	white	grey	... - ... - ...M2
		yellow	white	red	... - ... - ...M4
		grey	white	black	... - ... - ...M6
		yellow	white	black	... - ... - ...M7
		operator external dimension 48 × 48 mm 67 × 67 mm 88 × 88 mm	max. number of padlocks 3 3 4	hasp diameter of padlock 3 mm (min) / 5 mm (max) 4 mm (min) / 8 mm (max) 5 mm (min) / 9 mm (max)	
B-padlock device H406, H408, H410, H412 K616 K830		black	silver	black	... - ... - ...B1
		black	yellow	red	... - ... - ...B4
		black	black	black	... - ... - ...B8
		operator external dimension 75 × 114 mm 98 × 142 mm 130 × 178 mm	max. number of padlocks 4 4 4	hasp diameter of padlock 5 mm (min) / 8 mm (max) 5 mm (min) / 8 mm (max) 5 mm (min) / 8 mm (max)	
H-padlock device H406, H408, H410, H412 K616 K830		black	silver	black	... - ... - ...H1
		black	yellow	red	... - ... - ...H4
		black	black	black	... - ... - ...H8
		operator external dimension 75 × 114 mm 98 × 142 mm 130 × 178 mm	max. number of padlocks 4 4 4	hasp diameter of padlock 5 mm (min) / 8 mm (max) 5 mm (min) / 8 mm (max) 5 mm (min) / 8 mm (max)	
Padlockable with V-handle H216, H220, H226, H233 B240, B250, B263 H406, H408, H410, H412		black	silver	black	... - ... - ...V1
		black	yellow	red	... - ... - ...V4
		operator external dimension 48 × 48 mm 64 × 64 mm	max. number of padlocks 2 3	hasp diameter of padlock 3 mm (min) / 5 mm (max) 4 mm (min) / 6 mm (max)	
Installation mounting for 45 mm aperture in Panel/Distribution Boards:					
Padlockable with V-handle H216, H220, H226, H233 B240, B250, B263 H406, H408, H410, H412		grey	silver	black	... - ... - ...V1
		grey	yellow	red	... - ... - ...V4
		padlockable handle Size 2	max. number of padlocks 2	hasp diameter of padlock 3 mm (min) / 5 mm (max)	
Padlockable with V-handle (escutcheon imprinted) H406, H408, H410, H412		grey	–	black	... - ... - ...V1
		yellow	–	red	... - ... - ...V4
		padlockable handle Size 4	max. number of padlocks 3	hasp diameter of padlock 4 mm (min) / 6 mm (max)	

Disconnect Switches

Technical Information Operators

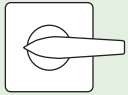
Operator variants for mounting forms with escutcheon and handle

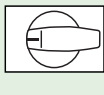
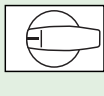
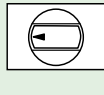
Operator Suitable for types		Colour escutcheon	Colour legend plate	Colour operator	Change of order code number
M-handle H216, H220, H226, H233 B240, B250, B263 H406, H408, H410, H412 K616		black grey white black black black	silver silver silver yellow silver black	black grey white red red black - - ...M1 - - ...M2 - - ...M3 - - ...M4 - - ...M5 - - ...M8
F-handle H216, H220, H226, H233 B240, B250, B263 H406, H408, H410, H412 K616		black grey white black black black	silver silver silver yellow silver black	black grey white red red black - - ...F1 - - ...F2 - - ...F3 - - ...F4 - - ...F5 - - ...F8
B-handle H216, H220, H226, H233 B240, B250, B263 H406, H408, H410, H412 K616		black grey white black black black	silver silver silver yellow silver black	black grey white red red black - - ...B1 - - ...B2 - - ...B3 - - ...B4 - - ...B5 - - ...B8
N-handle H216, H220, H226, H233 B240, B250, B263		black grey white black black black	silver silver silver yellow silver black	black grey white red red black - - ...N1 - - ...N2 - - ...N3 - - ...N4 - - ...N5 - - ...N8
G-handle H406, H408, H410, H412 K616 K830		black black black black	silver yellow silver black	black red red black - - ...G1 - - ...G4 - - ...G5 - - ...G8
R-handle H216, H220, H226, H233 B240, B250, B263		black grey white black black	silver silver silver yellow silver	black grey white red red - - ...R1 - - ...R2 - - ...R3 - - ...R4 - - ...R5
Installation mounting for 45 mm aperture in Panel/Distribution Boards:					
M-handle H216, H220, H226, H233 B240, B250, B263 H406, H408, H410, H412		grey grey grey	silver silver yellow	black grey red - - ...M1 - - ...M2 - - ...M4
M-handle (escutcheon imprinted) H406, H408, H410, H412		grey grey yellow	- - -	black grey red - - ...M1 - - ...M2 - - ...M4
N-handle H216, H220, H226, H233 B240, B250, B263		grey grey grey	silver silver yellow	black grey red - - ...N1 - - ...N2 - - ...N4

Utilization Categories

Utilization categories for Switches, Disconnectors, Switch-Disconnectors and Fuse-Combination Units according to IEC/EN 60947-3

Type of Current	Utilization Category		Typical applications
	Frequent operation	Occasional operation	
AC	AC-15A	AC-15B	Controlling electromagnetic load
	AC-20A *	AC-20B *	Making and breaking without load
	AC-21A	AC-21B	Switching resistive loads including low overloads
	AC-22A	AC-22B	Switching mixed resistive and inductive loads, including low overloads
	AC-23A	AC-23B	Switching motors and other highly inductive loads
DC	DC-20A *	DC-20B *	Making and breaking without load
	DC-21A	DC-21B	Switching resistive loads including low overloads
	DC-22A	DC-22B	Switching mixed resistive and inductive loads, including low overloads (e. g. shunt motors)
	DC-23A	DC-23B	Switching highly inductive loads (e. g. series motors)

* The application of these utilization categories isn't permitted in the USA.

Category AC-23 includes occasional switching of individual motors. The utilization categories in the above table do not apply to an equipment normally used to start, accelerate and/or stop individual motors. The utilization categories for such an equipment are dealt with the following table:

Type of Current	Utilization Category	Typical applications
AC	AC-2	Slip-ring motors: starting, plugging ¹⁾ , switching off
	AC-3	Squirrel-cage motors: starting, switching off running motors
	AC-4	Squirrel-cage motors: starting, plugging ¹⁾ , inching ²⁾
DC	DC-3	Shunt motors: starting, plugging ¹⁾ , inching ²⁾ , dynamic breaking of d.c. motors
	DC-4	Series motors: starting, plugging ¹⁾ , inching ²⁾ , dynamic breaking of d.c. motors

¹⁾ Plugging is understood to mean stopping or reversing the motor rapidly by reversing motor primary connections while the motor is running.

²⁾ Inching (jogging) is understood to mean energizing a motor once or repeatedly for short periods to obtain small movements of the driven mechanism.

Note: The switching of rotor circuits, capacitors or tungsten filament/discharge lamps shall be subject to special agreements between manufacturer and user.

Disconnect Switches

Technical Information Rated currents

Rated currents of three-phase motors (approximate figures for squirrel-cage motors)

Motor rating			Motor full-load current			Fuse starting			Motor full-load current			Fuse starting		
kW	cos φ	Percent efficiency η %	A	A	Y/Δ A	A	A	Y/Δ A	A	A	A	A	A	Y/Δ A
			230 V						400 V					
0,06	0,7	58	0,37	2	—	0,21	2	—						
0,09	0,7	60	0,54	2	—	0,31	2	—						
0,12	0,7	60	0,72	4	2	0,41	2	—						
0,18	0,7	62	1,04	4	2	0,6	2	—						
0,25	0,7	62	1,4	4	2	0,8	4	2						
0,37	0,72	66	2	6	4	1,1	4	2						
0,55	0,75	69	2,7	10	4	1,5	4	2						
0,75	0,79	74	3,2	10	4	1,9	6	4						
1,1	0,81	74	4,6	10	6	2,6	6	4						
1,5	0,81	74	6,3	16	10	3,6	6	4						
2,2	0,81	78	8,7	20	10	5	10	6						
3	0,82	80	11,5	25	16	6,6	16	10						
4	0,82	83	14,8	32	16	8,5	20	10						
5,5	0,82	86	19,6	32	25	11,3	25	16						
7,5	0,82	87	26,4	50	32	15,2	32	16						
11	0,84	87	38	80	40	21,7	40	25						
15	0,84	88	51	100	63	29,3	63	32						
18,5	0,84	88	63	125	80	36	63	40						
22	0,84	92	71	125	80	41	80	50						
30	0,85	92	96	200	100	55	100	63						
37	0,86	92	117	200	125	68	125	80						
45	0,86	93	141	250	160	81	160	100						
55	0,86	93	173	250	200	99	200	125						
75	0,86	94	233	315	250	134	200	160						
90	0,86	94	279	400	315	161	250	200						
110	0,86	94	342	500	400	196	315	200						
132	0,87	95	401	630	500	231	400	250						
160	0,87	95	486	630	630	279	400	315						
200	0,87	95	607	800	630	349	500	400						
250	0,87	95	—	—	—	437	630	500						
315	0,87	96	—	—	—	544	800	630						
400	0,88	96	—	—	—	683	1000	800						
			500 V						690 V					
0,06	0,7	58	0,17	2	—	0,12	2	—						
0,09	0,7	60	0,25	2	—	0,18	2	—						
0,12	0,7	60	0,33	2	—	0,24	2	—						
0,18	0,7	62	0,48	2	—	0,35	2	—						
0,25	0,7	62	0,7	2	—	0,5	2	—						
0,37	0,72	66	0,9	2	2	0,7	2	—						
0,55	0,75	69	1,2	4	2	0,9	4	2						
0,75	0,79	74	1,5	4	2	1,1	4	2						
1,1	0,81	74	2,1	6	4	1,5	4	2						
1,5	0,81	74	2,9	6	4	2,1	6	4						
2,2	0,81	78	4	10	4	2,9	10	4						
3	0,82	80	5,3	16	6	3,8	10	4						
4	0,82	83	6,8	16	10	4,9	16	6						
5,5	0,82	86	9	20	16	6,5	16	10						
7,5	0,82	87	12,1	25	16	8,8	25	10						
11	0,84	87	17,4	32	20	12,6	25	16						
15	0,84	88	23,4	50	25	17	32	20						
18,5	0,84	88	28,9	50	32	20,9	32	25						
22	0,84	92	33	63	32	23,8	50	25						
30	0,85	92	44	80	50	32	63	32						
37	0,86	92	54	100	63	39	80	50						
45	0,86	93	65	125	80	47	80	63						
55	0,86	93	79	160	80	58	100	63						
75	0,86	94	107	200	125	78	160	100						
90	0,86	94	129	200	160	93	160	100						
110	0,86	94	157	250	160	114	200	125						
132	0,87	95	184	250	200	134	250	160						
160	0,87	95	224	315	250	162	250	200						
200	0,87	95	279	400	315	202	315	250						
250	0,87	95	349	500	400	253	400	315						
315	0,87	96	436	630	500	316	500	400						
400	0,88	96	547	800	630	396	630	400						

The rated motor currents are for standard 1500 r.p.m. motors with normal inner and outer surface cooling

Fuse: This table applies to "slow" or "gl"



D.O.L. starting: Maximum starting current: 6 × rated current. Maximum starting time: 5 sec.

Y/Δ starting: Maximum starting current: 2 × rated current. Maximum starting time: 15 sec.

IP Codes

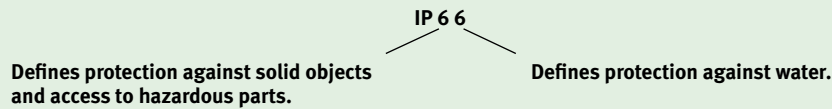
A coding system is defined by IEC/EN 60529 for the classification of degrees of protection provided by enclosures of electrical equipment against solid objects and water. This coding comprises the letters 'IP' followed by a two digit code as follows:

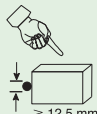
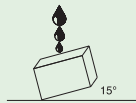
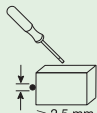
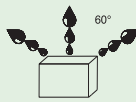
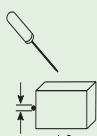
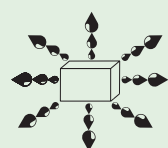
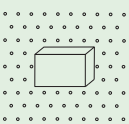
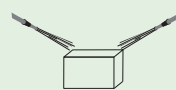
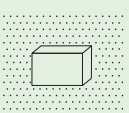
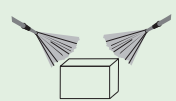
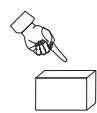
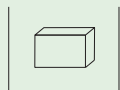
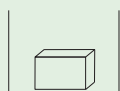

1 st digit	protection against solid objects and access to hazardous parts	2 nd digit	Protection against water
0	No protection.	0	No protection.
1	 No ingress by solid objects ≥ 50 mm dia nor access to hazardous parts with the back of the hand.	1	 Vertically falling drops of water shall have no harmful effect.
2	 No ingress by solid objects ≥ 12.5 mm dia nor access to hazardous parts with a finger.	2	 Vertically falling drops of water shall have no harmful effect when the enclosure is tilted at any angle up to 15° from vertical.
3	 No ingress by solid objects ≥ 2.5 mm dia nor access to hazardous parts with a tool.	3	 Water sprayed at up to 60° from the vertical shall have no harmful effect.
4	 No ingress by solid objects ≥ 1.0 mm dia nor access to hazardous parts with a wire.	4	 Water splashed from any direction shall have no harmful effect.
5	 Dust protected. Ingress of dust is not completely prevented, but there should be no harmful deposits. No access to hazardous parts with a wire.	5	 Jets of water projected from any direction shall have no harmful effect.
6	 Dust tight. No ingress of dust. No access to hazardous parts with a wire.	6	 Strong jets of water projected from any direction shall have no harmful effect.
1B	 Test finger penetration to a maximum of 80 mm must not contact hazardous parts.	7	 Temporary immersion in water shall not result in ingress of harmful quantities of water.
		8	 Continuous immersion in water shall not result in ingress of harmful quantities of water.

Disconnect Switches

Technical Information Technical Data

Rated data

Rated data			H216	H220	H226	H233	B240	B250	B263	H406	H408	H410	H412	K616	K830
Operational voltage U_e	(V AC)		690	690	690	690	690	690	690	690 ¹	690 ¹	690 ¹	690 ¹	690	690
Impulse withstand voltage U_{imp}	(kV)		6	6	6	6	6	6	6	8	8	8	8	6	6
Overvoltage category			III	III	III	III	III	III	III	III	III	III	III	III	III
Pollution degree			3	3	3	3	3	3	3	3	3	3	3	3	3
Uninterrupted current $I_u / I_{th} / I_{the}$	(A)		20	25	32	40	40	50	63	63	80	100	125	160	315
Load capacity in intermittent operation (class 12)	(AB)		DF: 60% = $1,3 \times I_e$ / 40% = $1,6 \times I_e$ / 25% = $2 \times I_e$												
Breaking capacity	220–240V	(A)	150	250	300	330	340	340	340	500	550	600	800	900	1800
	380–440V	(A)	150	250	300	330	340	340	340	500	550	600	750	850	1650
	500–690V	(A)	100	150	190	220	200	200	200	270	285	300	320	340	350
Short-circuit rating (max. fuse)	(gL)		20	25	35	40	40	50	63	63	80	100	125	160	315
Conditional short-circuit current	(kA_{eff})		15	15	15	15	—	—	—	25	25	25	25	25	25
Short-circuit making capacity I_{cm}	(kA)		—	—	—	—	1,4	1,6	1,8	—	—	—	—	—	—
Short-time withstand current (1 s)	(A)		—	—	—	—	500	600	750	—	—	—	—	—	—
Isolating characteristics (to EN 60947)	(up to ... V AC)		690	690	690	690	690	690	690	1000	1000	1000	1000	690	690
Switching angle			90°	90°	90°	90°	90°	90°	90°	90°	90°	90°	90°	90°	90°
Contacts (Current paths) (max.)			8	8	8	8	8	8	8	8	8	8	8	8	8
Current heat loss per contact at I_u	(W)		0,8	0,8	1,8	2,1	2,0	2,4	3,0	3,0	4,1	5,5	6,9	11	28,5
Terminal capacity															
solid or stranded	min.	(mm ²)	1	1	1	1	6	6	6	4	4	4	4	95 ²	185 ²
	max.	(mm ²)	10	10	10	10	25	25	25	50	50	50	50	95 ²	185 ²
flexible or multiwire (including ferrule)	min.	(mm ²)	0,75	0,75	0,75	0,75	4	4	4	2,5	2,5	2,5	2,5	95 ²	185 ²
	max.	(mm ²)	6	6	6	6	16	16	16	35	35	35	35	95 ²	185 ²
American Wire Gauge	(AWG)		8	8	8	8	4	4	4	1/0	1/0	1/0	1/0	4/0	350MCM
Thread dimensions for terminal screw			M4	M4	M4	M4	M4	M4	M4	M5	M5	M5	M5	M10	M12
Terminal tightening torque	min.	(Nm)	1,2	1,2	1,2	1,2	1,2	1,2	1,2	2,0	2,0	2,0	2,0	10	14
	max.	(Nm)	2,5	2,5	2,5	2,5	2,5	2,5	2,5	5,0	5,0	5,0	5,0	20	25
Operational current I_e															
AC-21A	220–500V	(A)	20	25	32	40	40	50	63	63	80	100	125	160	315
	660–690V	(A)	16	20	32	40	40	50	63	63	80	100	100	125	125
AC-22A	400V	(A)	12	16	24	32	32	38	47	47	65	80	97	120	285
cUL General Use	300V AC	(A)	20	25	30	40	— ³	— ³	— ³	— ³	80	100	— ³	175	240
	600V AC	(A)	20	25	30	40	— ³	— ³	— ³	— ³	80	100	— ³	175	240
Operational power 50–60 Hz (3 phase)															
AC-23A	220–240V	(kW)	3	4	5,5	7,5	7,5	11	15	15	18,5	22	30	37	75
	380–440V	(kW)	5,5	7,5	11	15	15	18,5	22	22	30	37	45	75	132
	500V	(kW)	5,5	7,5	11	15	18,5	18,5	22	22	30	37	45	90	132
	660–690V	(kW)	5,5	7,5	11	15	15	18,5	22	22	30	37	37	55	55
AC-3	220–240V	(kW)	2,2	3	4	5,5	7,5	7,5	11	11	15	22	30	22	37
	380–440V	(kW)	3,7	5,5	7,5	11	11	15	18,5	18,5	22	30	37	45	55
	500V	(kW)	3,7	5,5	7,5	11	15	15	18,5	18,5	30	37	45	45	55
	660–690V	(kW)	3,7	5,5	7,5	11	11	15	18,5	18,5	22	30	37	45	55
cUL	110–120V AC	(HP)	1	1,5	2	3	— ³	— ³	— ³	— ³	7,5	10	— ³	15	25
	208V AC	(HP)	2	3	5	7,5	— ³	— ³	— ³	— ³	10	15	— ³	15	30
	220–240V AC	(HP)	2	3	5	7,5	— ³	— ³	— ³	— ³	20	25	— ³	15	30
	440–480V AC	(HP)	3	5	10	15	— ³	— ³	— ³	— ³	30	30	— ³	40	50
550–600V AC	(HP)	5	5	10	15	— ³	— ³	— ³	— ³	30	30	— ³	50	50	

¹ 1000V, AC-20, no load switching

² with terminal extensions for cable lug connection

³ in testing

Rated data

Rated data (auxiliary contacts)			H216	H220	H226	H233	B240	B250	B263	H406	H408	H410	H412	K616	K830
Operational voltage U_e	(V AC)		500	500	500	500	500	500	500	500	500	500	500	500	500
Uninterrupted current $I_u / I_{th} / I_{the}$	(A)		10	10	10	10	16	16	16	16	16	16	16	20	20
Operational current I_e															
AC-21A	(A)		10	10	10	10	10	10	10	10	10	10	10	20	20
		110–240V (A)	2,5	2,5	2,5	2,5	6	6	6	6	6	6	6	6	6
AC-15		380–440V (A)	1,5	1,5	1,5	1,5	4	4	4	4	4	4	4	4	4
		500V (A)	1	1	1	1	1,5	1,5	1,5	1,5	1,5	1,5	1,5	2	2
cUL General Use		600V AC (A)	10	10	10	10	10	10	10	10	10	10	10	20	20
Heavy Pilot Duty			A600	A600	A600	A600	A600	A600	A600	A600	A600	A600	A600	A600	A600
short-circuit rating (max. fuse)	(gL)		10	10	10	10	16	16	16	16	16	16	16	20	20
Conditional short-circuit current	(kA_{eff})		3	3	3	3	3	3	3	3	3	3	3	10	10
Terminal capacity															
flexible or multiwire	min.	(mm ²)	1	1	1	1	1	1	1	1	1	1	1	1	1
(including ferrule)	max.	(mm ²)	2,5	2,5	2,5	2,5	2,5	2,5	2,5	2,5	2,5	2,5	2,5	2,5	2,5
American Wire Gauge		(AWG)	14	14	14	14	14	14	14	14	14	14	14	12	12

General

General			H216	H220	H226	H233	B240	B250	B263	H406	H408	H410	H412	K616	K830
Standards			IEC 60947 / EN 60947 / IEC 60204 / UL 508 / CSA 22.2, No. 14 / VDE 0660 part 107												
Mechanical lifespan			>10 ⁵	>10 ⁵	>10 ⁵	>10 ⁵	>10 ⁵	>10 ⁵	>10 ⁵	>10 ⁵	>10 ⁵	>10 ⁵	>10 ⁵	>10 ⁶	>10 ⁶
Max. operating frequency / h			50	50	50	50	50	50	50	50	50	50	50	50	50
Climatic resistance	constant		to DIN IEC 60068-2-78												
(damp heat)	cyclic		to DIN IEC 60068-2-30												
Ambient temperature	open	(°C)	–25 / +50												
(min. / max.)	enclosed	(°C)	–25 / +40												
Mounting position			as required												
Mechanical shock resistance		(g)	>25	>25	>25	>25	>25	>25	>25	>25	>25	>25	>25	>10	>10
(shock duration 20ms)															
Rated frequency		(Hz)	50 to 60 (other frequencies on request)												

Conformity

The Disconnect Switches H, B and K conform to the regulations of the EC guideline 2006/95/EG ‘Electrical equipment for application within certain voltage limits’ – specified as directive for low voltage devices.

The conformity is proved by the complete compliance of the harmonized EN 60947-1, EN 60947-3, EN 60947-5-1, EN 60204-1.

Sälzer Electric products are developed, manufactured and tested according to these standards. The CE marking on all our products prove the conformity to the directives.

Disconnect Switches from Sälzer are approved according to cUL 508 and GOST R500 30.3-99.

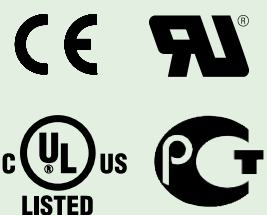

Disconnect Switches

Mounting form table

Mtg. form	Application	as of page	Mtg. form	Application	as of page	Mtg. form	Application	as of page
003G1	ON-OFF Switch	80	087N4	Main/Emergency-Off Switch	38	197V4	Main/Emergency-Off Switch	44
003G1	Changeover Switch	109	087V1	Main Switch	72	198M1	Changeover Switch	130
003H1	Changeover Switch	109	087V4	Main/Emergency-Off Switch	38	198V1	Changeover Switch	130
003M1	ON-OFF Switch	80	096M1	ON-OFF Switch	107	203V1	Changeover Switch	112
003M1	Changeover Switch	109	097M1	Main Switch	78	204M1	Changeover Switch	112
003V1	Changeover Switch	109	097M4	Main/Emergency-Off Switch	44	204V1	Changeover Switch	112
004H1	Changeover Switch	109	097N1	Main Switch	78	206M1	Main Switch	51
004V1	Changeover Switch	109	097N4	Main/Emergency-Off Switch	44	206M4	Main/Emergency-Off Switch	17
013G1	ON-OFF Switch	80	097V1	Main Switch	78	206N1	Main Switch	51
013G1	Changeover Switch	109	097V4	Main/Emergency-Off Switch	44	206N4	Main/Emergency-Off Switch	17
013H1	Changeover Switch	109	126M1	ON-OFF Switch	86	206V1	Main Switch	51
013M1	ON-OFF Switch	80	126M1	Changeover Switch	113	206V4	Main/Emergency-Off Switch	17
013M1	Changeover Switch	109	126V1	Main Switch	53	208M1	ON-OFF Switch	84
013V1	Changeover Switch	109	126V4	Main/Emergency-Off Switch	19	209M1	ON-OFF Switch	84
014H1	Changeover Switch	109	127V1	Changeover Switch	113	213V1	Changeover Switch	112
014V1	Changeover Switch	109	128V1	Changeover Switch	113	214M1	Changeover Switch	112
026M1	ON-OFF Switch	86	136M1	Main Switch	46	214V1	Changeover Switch	112
026M1	Changeover Switch	113	136M4	Main/Emergency-Off Switch	12	216M1	Main Switch	51
026N2	ON-OFF Switch	86	136N1	Main Switch	46	216M4	Main/Emergency-Off Switch	17
026V1	Main Switch	53	136N4	Main/Emergency-Off Switch	12	216N1	Main Switch	51
026V4	Main/Emergency-Off Switch	19	176H1	Changeover Switch	124	216N4	Main/Emergency-Off Switch	17
027V1	Changeover Switch	113	177H1	Main Switch	65	216V1	Main Switch	51
028V1	Changeover Switch	113	177H4	Main/Emergency-Off Switch	31	216V4	Main/Emergency-Off Switch	17
033H1	Main Switch	46	181M1	ON-OFF Switch	104	218M1	ON-OFF Switch	84
033H4	Main/Emergency-Off Switch	12	181M1	Changeover Switch	127	219M1	ON-OFF Switch	84
033M1	Main Switch	46	182M1	Main Switch	72	234M1	Main Switch	56
033M4	Main/Emergency-Off Switch	12	182M4	Main/Emergency-Off Switch	38	234M4	Main/Emergency-Off Switch	22
033N1	Main Switch	46	182N1	Main Switch	72	234N1	Main Switch	56
033N4	Main/Emergency-Off Switch	12	182N4	Main/Emergency-Off Switch	38	234N4	Main/Emergency-Off Switch	22
033V1	Main Switch	46	183H1	Changeover Switch	127	234V1	Main Switch	56
033V4	Main/Emergency-Off Switch	12	186H1	Changeover Switch	127	234V4	Main/Emergency-Off Switch	22
034H1	Main Switch	63	186M1	ON-OFF Switch	104	238M1	Main Switch	56
034H4	Main/Emergency-Off Switch	29	186M1	Changeover Switch	127	238M4	Main/Emergency-Off Switch	22
034M1	Main Switch	63	186V1	Changeover Switch	127	238N1	Main Switch	56
034M4	Main/Emergency-Off Switch	29	187H1	Main Switch	72	238N4	Main/Emergency-Off Switch	22
034N1	Main Switch	63	187H4	Main/Emergency-Off Switch	38	238V1	Main Switch	56
034N4	Main/Emergency-Off Switch	29	187M1	Main Switch	72	238V4	Main/Emergency-Off Switch	22
036M1	Main Switch	46	187M4	Main/Emergency-Off Switch	38	242M1	ON-OFF Switch	89
036M4	Main/Emergency-Off Switch	12	187N1	Main Switch	72	242M1	Changeover Switch	116
036N1	Main Switch	46	187N4	Main/Emergency-Off Switch	38	242V1	Changeover Switch	116
036N4	Main/Emergency-Off Switch	12	187V1	Main Switch	72	243V1	Changeover Switch	116
036V1	Main Switch	46	187V4	Main/Emergency-Off Switch	38	248M1	ON-OFF Switch	89
036V4	Main/Emergency-Off Switch	12	188M1	Changeover Switch	127	248M1	Changeover Switch	116
042G1	ON-OFF Switch	96	188V1	Changeover Switch	127	248V1	Changeover Switch	116
042G1	Changeover Switch	120	189H1	Changeover Switch	127	249V1	Changeover Switch	116
042H1	Changeover Switch	120	196M1	ON-OFF Switch	107	281M1	Main Switch	56
043H1	Changeover Switch	120	196M1	Changeover Switch	130	281M4	Main/Emergency-Off Switch	22
077H1	Main Switch	65	196V1	Changeover Switch	130	281N1	Main Switch	56
077H4	Main/Emergency-Off Switch	31	197M1	Main Switch	78	281N4	Main/Emergency-Off Switch	22
086M1	ON-OFF Switch	104	197M4	Main/Emergency-Off Switch	44	281V1	Main Switch	56
087M1	Main Switch	72	197N1	Main Switch	78	281V4	Main/Emergency-Off Switch	22
087M4	Main/Emergency-Off Switch	38	197N4	Main/Emergency-Off Switch	44	283M1	ON-OFF Switch	89
087N1	Main Switch	72	197V1	Main Switch	78	283M1	Changeover Switch	116

Mounting form table

Mtg. form	Application	as of page	Mtg. form	Application	as of page	Mtg. form	Application	as of page
283V1	Changeover Switch	116	710V1	Main Switch	65	976M1	ON-OFF Switch	100
285M1	ON-OFF Switch	91	710V4	Main/Emergency-Off Switch	31	976M1	Changeover Switch	122
285M1	Changeover Switch	116	711M1	ON-OFF Switch	98	977M1	Main Switch	67
285V1	Changeover Switch	116	715M1	Main Switch	71	977M4	Main/Emergency-Off Switch	33
286H1	Changeover Switch	127	715M4	Main/Emergency-Off Switch	37	977N1	Main Switch	67
287H1	Main Switch	72	715N1	Main Switch	71	977N4	Main/Emergency-Off Switch	33
287H4	Main/Emergency-Off Switch	38	715N4	Main/Emergency-Off Switch	37	978M1	Changeover Switch	122
291V1	Changeover Switch	116	715V1	Main Switch	71	979H1	Changeover Switch	124
293V1	Changeover Switch	116	715V4	Main/Emergency-Off Switch	37	986M1	ON-OFF Switch	104
449V1	Changeover Switch	116	716M1	ON-OFF Switch	103	987M1	Main Switch	72
476M1	ON-OFF Switch	98	720M1	Main Switch	67	987M4	Main/Emergency-Off Switch	38
477M1	Main Switch	65	720M4	Main/Emergency-Off Switch	33	987N1	Main Switch	72
477M4	Main/Emergency-Off Switch	31	720N1	Main Switch	67	987N4	Main/Emergency-Off Switch	38
477N1	Main Switch	65	720N4	Main/Emergency-Off Switch	33	996M1	ON-OFF Switch	107
477N4	Main/Emergency-Off Switch	31	720V1	Main Switch	67	997M1	Main Switch	78
481M1	ON-OFF Switch	89	720V4	Main/Emergency-Off Switch	33	997M4	Main/Emergency-Off Switch	44
481M1	Changeover Switch	116	721M1	ON-OFF Switch	100	997N1	Main Switch	78
481V1	Changeover Switch	116	725M1	Main Switch	71	997N4	Main/Emergency-Off Switch	44
482M1	ON-OFF Switch	89	725M4	Main/Emergency-Off Switch	37			
482M1	Changeover Switch	116	725N1	Main Switch	71			
482V1	Changeover Switch	116	725N4	Main/Emergency-Off Switch	37			
483M1	Main Switch	56	725V1	Main Switch	71			
483M4	Main/Emergency-Off Switch	22	725V4	Main/Emergency-Off Switch	37			
483N1	Main Switch	56	726M1	ON-OFF Switch	103			
483N4	Main/Emergency-Off Switch	22	727M1	Changeover Switch	126			
483V1	Main Switch	56	728V1	Changeover Switch	122			
483V4	Main/Emergency-Off Switch	22	730M1	Main Switch	65			
484M1	Main Switch	56	730M4	Main/Emergency-Off Switch	31			
484M4	Main/Emergency-Off Switch	22	730N1	Main Switch	65			
484N1	Main Switch	56	730N4	Main/Emergency-Off Switch	31			
484N4	Main/Emergency-Off Switch	22	730V1	Main Switch	65			
484V1	Main Switch	56	730V4	Main/Emergency-Off Switch	31			
484V4	Main/Emergency-Off Switch	22	731M1	ON-OFF Switch	98			
485V1	Changeover Switch	116	732M1	Changeover Switch	122			
576H1	Changeover Switch	124	732V1	Changeover Switch	122			
576M1	Changeover Switch	122	733M1	Main Switch	67			
577M1	Main Switch	67	733M4	Main/Emergency-Off Switch	33			
577M4	Main/Emergency-Off Switch	33	733N1	Main Switch	67			
577N1	Main Switch	67	733N4	Main/Emergency-Off Switch	33			
577N4	Main/Emergency-Off Switch	33	733V1	Main Switch	67			
578M1	ON-OFF Switch	100	733V4	Main/Emergency-Off Switch	33			
579H1	Changeover Switch	124	734M1	ON-OFF Switch	100			
700M1	Main Switch	65	770M1	Main Switch	65			
700M4	Main/Emergency-Off Switch	31	770M4	Main/Emergency-Off Switch	31			
700N1	Main Switch	65	770N1	Main Switch	65			
700N4	Main/Emergency-Off Switch	31	770N4	Main/Emergency-Off Switch	31			
700V1	Main Switch	65	770V1	Main Switch	65			
700V4	Main/Emergency-Off Switch	31	770V4	Main/Emergency-Off Switch	31			
701M1	ON-OFF Switch	98	771M1	ON-OFF Switch	98			
710M1	Main Switch	65	772M1	Changeover Switch	122			
710M4	Main/Emergency-Off Switch	31	772V1	Changeover Switch	122			
710N1	Main Switch	65	773V1	Changeover Switch	122			
710N4	Main/Emergency-Off Switch	31	976H1	Changeover Switch	124			

Disconnect Switches

Contacts

Your contacts worldwide



GERMANY

Sälzer Electric GmbH

Matthiasstraße 16
57482 Wenden

T +49 (0) 27 62 - 6 14-110
F +49 (0) 27 62 - 6 14-100

info@salzer.de
www.saelzer.com



GREAT BRITAIN

Salzer UK Ltd.

44 Edison Road
Aylesbury Bucks.
HP19 8TE

T +44 (0) 12 96 - 39 99 92
F +44 (0) 12 96 - 39 22 29

info@salzeruk.co.uk
www.salzeruk.co.uk



U.S. A. / CANADA / MEXICO

Salzer USA Corporation

3802 N. 54th Street
Mesa, AZ 85215

T +1 480-325-2690
F +1 480-985-9663

info@salzerusa.com
www.salzerusa.com



AUSTRIA

Schmachtl GmbH
Pummererstraße 36
4020 Linz

T +43 (0) 7 32 - 76 46-0
F +43 (0) 7 32 - 78 50 36

office.linz@schmachtl.at
www.schmachtl.at



BELGIUM



LUXEMBURG

Bintz technics N. V.
Brixtonlaan 23
Business Park
1930 Zaventem

T +32 (0) 2 - 720 49 16
F +32 (0) 2 - 720 37 50

info@bintz.be
www.bintz.be



CZECHIA



SLOVAKIA

WAPRO spol. s r.o.
Rumunská 27
79601 Prostějov

T +420 582 334 676
F +420 582 334 677

info@wapro.cz
www.wapro.cz



DENMARK

Gycom Danmark A/S
Theilgaards Torv 1
4600 Køge

T +45 - 56 26 66 35
F +45 - 56 26 77 78

admin@gycom.dk
www.gycom.com



FINLAND



ESTONIA



LATVIA

UTU Oy
PL 20
29401 Ulvila

T +358 - 9 - 2746 411
F +358 - 9 - 2746 4141

powel@utu.eu
www.utupowel.fi



FRANCE

AER – ERIS
22, rue Becquerel
Zl des Garennes
78130 Les Mureaux

T +33 (0) 1 30 22 39 60
F +33 (0) 1 30 99 80 63

www.eris-fr.com



IRELAND

MCC Controls Ltd.
Robinhood Business Park
Robinhood Rd.
22 Dublin

T +353 (0) 1 - 4 50 64 50
F +353 (0) 1 - 4 50 61 04

sales@mcc-controls.com
www.mcc-controls.com



ITALY

Telestar S. r. l.
Via C. Colombo, 13
22069 Rovellasca (CO)

T +39 (0) 02 96 74 02 68
F +39 (0) 02 96 74 02 73

telestar@telestar-automation.it
www.telestar-automation.it



KUWAIT

The United Towers
Trading & Contracting Est.
Old Khaitan,
Block 45+46, Building 12
KWT 13157 Office No.1, Mezzanine

T +965 - 24745960
F +965 - 24727452

theunitedtowers@yahoo.com



NETHERLANDS

Solar Nederland B.V.
Effect 5
6921 RG Duiven

T +31 (0) 26 - 365 29 11
F +31 (0) 26 - 365 23 46

industrie@solarnederland.nl
www.solarnederland.nl



NORWAY

EFA ELEKTRO A. S.
Postboks 593
1411 Kolbotn

T +47 - 6681 2400
F +47 - 6680 0478

post@efa.no
www.efa.no



SINGAPORE

Electrimec Asia Pacific Pte Ltd
17 Tuas Street (Off Pioneer Road)
Singapore 638454

T +65 - 6896 2979
F +65 - 6896 2925

elecmecc@singnet.com.sg



SOUTH AFRICA

Waco Industries
11, Cleveland Road
Cleveland – Johannesburg

T +27 (0) 11 - 677 2500
F +27 (0) 11 - 677 2608

wacobuy@voltex.co.za
www.wacoelec.co.za



SPAIN

Euromatel S. L.
Avenida Real de Pinto, 87
Nave II-A
28021 Madrid

T +34 - 91 - 3 58 92 70
F +34 - 91 - 3 58 92 95

info@euromatel.es
www.euromatel.es



SWEDEN

Gycom Nordic AB
Box 1203
183 12 Täby

T +46 - 8 - 632 30 00
F +46 - 8 - 792 06 54

info@gycom.se
www.gycom.com



SWITZERLAND

EHS Elektrotechnik AG
Industriestrasse 26
8604 Volketswil

T +41 (0) 44 - 908 40 50
F +41 (0) 44 - 908 40 55

info@ehs.ch
www.ehs.ch



Sälzer Electric GmbH
Matthiasstraße 16
57482 Wenden (Germany)
www.saelzer.com

Headquarters:
Tel. +49 (0) 27 62 / 614-110
Fax +49 (0) 27 62 / 614-100
sales@salzer.de

Technical Support:
Tel. +49 (0) 37 37 / 87-0
Fax +49 (0) 37 37 / 87-226
support@salzer.de

www.saelzer.com