

Product Data Sheet



Product Code:	Issue No.	Issue Date:	Issue by:
GTT22	A	10.03.10	L.F

Description

50 x 50, 90 DEGREE TOP LID TRUNKING TEE

Features

Lid is secured using 'Bridge Pieces'.
 Bridge pieces act as cable retainers.
 Special sizes can be made to order.
 Multi compartment versions available.

90 degree tees simply slide into the trunking ends
 and bolt to both side walls through the 7mm
 obround holes.

Special trunking with customer specified powder
 coated paint finish also offered

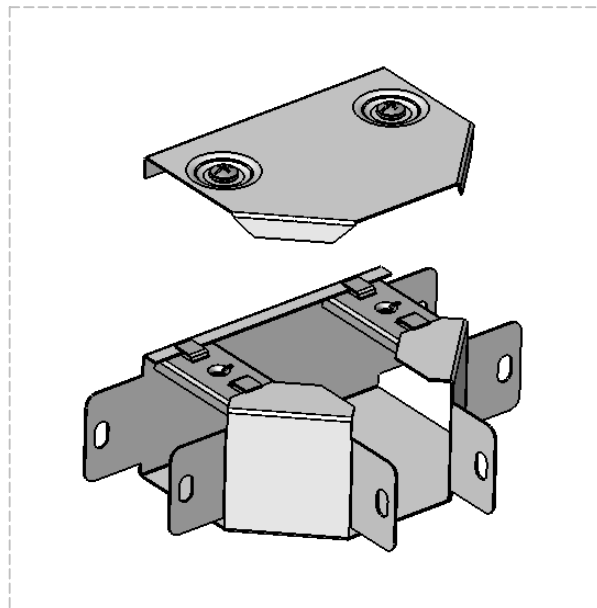

General Characteristics

Material	Low carbon steel strip (BSEN10346:2009)
Finish	Pre-galvanized steel
Supplied length	N/A
Size	50 x 50mm

IMPORTANT:
 Cable trunking is designed such that
 the main body carries the weight of
 cables. Trunking should NOT be
 installed in any way that causes the
 lid to carry the cable weight.

Dimensions

