

IP65 Moisture-proof diffuser luminaire

IP65 LED Moisture proof luminaire with opal diffuser for indoor and covered outdoor installation. Innovative design with extra long bracket sliders (200 mm) for ease of installation making it an ideal refurbishment luminaire. Made of high quality polycarbonate (UV stabilised), the design is streamlined and clip free, whilst still providing easy but secure access to the driver. Total luminous flux: 2200 lm, Luminaire input power: 18 W, Lamp efficacy: 122 lm/W, CCT: 4000K, Lifetime: 50.000hrs @L80, Colour Rendering: CRI > 80. Chromaticity tolerance (initial MacAdam): 4, Impact strength: IK08. Tool-free installation, BESA compatible. Available accessories: Plug&Play Emergency kit for 3 hour emergency conversion (self- and manual test) and suspension kit. Lumen package adjustable on site by 3 steps (FLEX1: 2200 lm (18W), FLEX2: 1500 lm (12W), FLEX3: 1000 lm (8W)). Detailed power setting information available on www.THORNeco.com. Dimensions: 635 x 94 x 76 mm, weight: 0.8 kg.

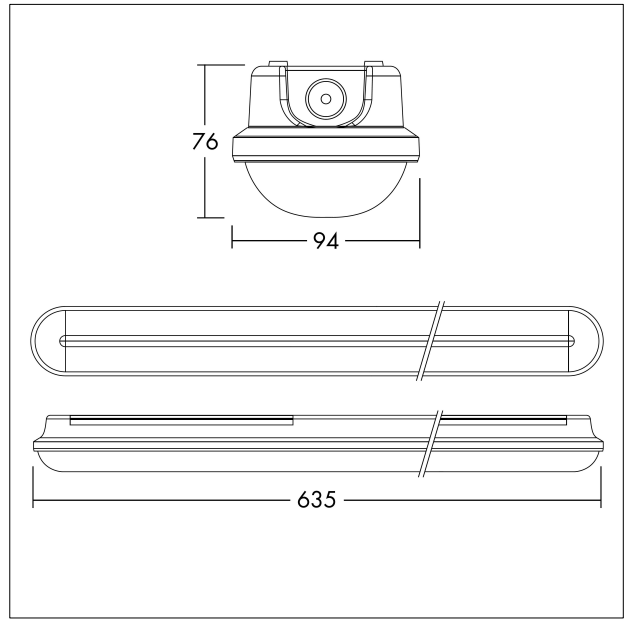

TE_JULIEF_F_PERSP_ON.jpg



TE_JULIEF_M_600.wmf

Light Distribution

STD - standard

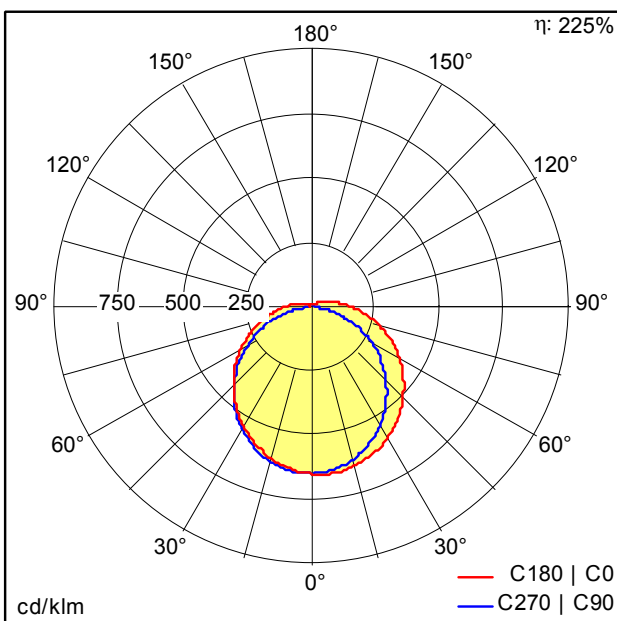

TE_JULIE_FLEX_600_2200_840_FLEX1.idt

- Light Source: LED
- Luminaire luminous flux*: 4952 lm
- Colour Rendering Index min.: 80
- Correlated colour temperature*: 4000 Kelvin
- Chromaticity tolerance (initial MacAdam): 4
- Rated median useful life*:
L80 50000h at 25°C
- Ballast: 1x LED_Con
- Luminaire input power*: 18 W Power factor = 0.9
- Dimming: Fixed output
- Maintenance category: E - Dust-proof IP5X
- Total harmonic distortion (THD): 20.00 %

All values marked with an * are rated values. Luminous flux and connected electrical load are subject to an initial tolerance of +/- 10%. Unless stated otherwise, the values apply to an ambient temperature of 25°C.