

Mounting Brackets

PAGE 1 of 2

HY1GMBH
HY1GMBV
HY1GMBF
HY1GWBMC
HY1GWBMC13
HY1GWBMC16
HY1GMBVH
HY1GMBNP
HY1GMBVNP
HY1GMBNPX
HY1GMBVNPX
HY1GMBPL
HY1GMBPLR
HY1GMBGN
HYPBPC

*See current catalogue for further detail



Hyena Mounting Brackets

- Trader brackets are available for many different construction applications
- They feature 84mm mounting centres with 6/32 UNC standard mounting threads to suit Australian accessories
- The aperture sizes are designed to suit the majority of Australian accessories in the market
- Made from strong durable electro-galvanised zinc steel
- Models available for timber construction, steel frames and brick/masonry applications

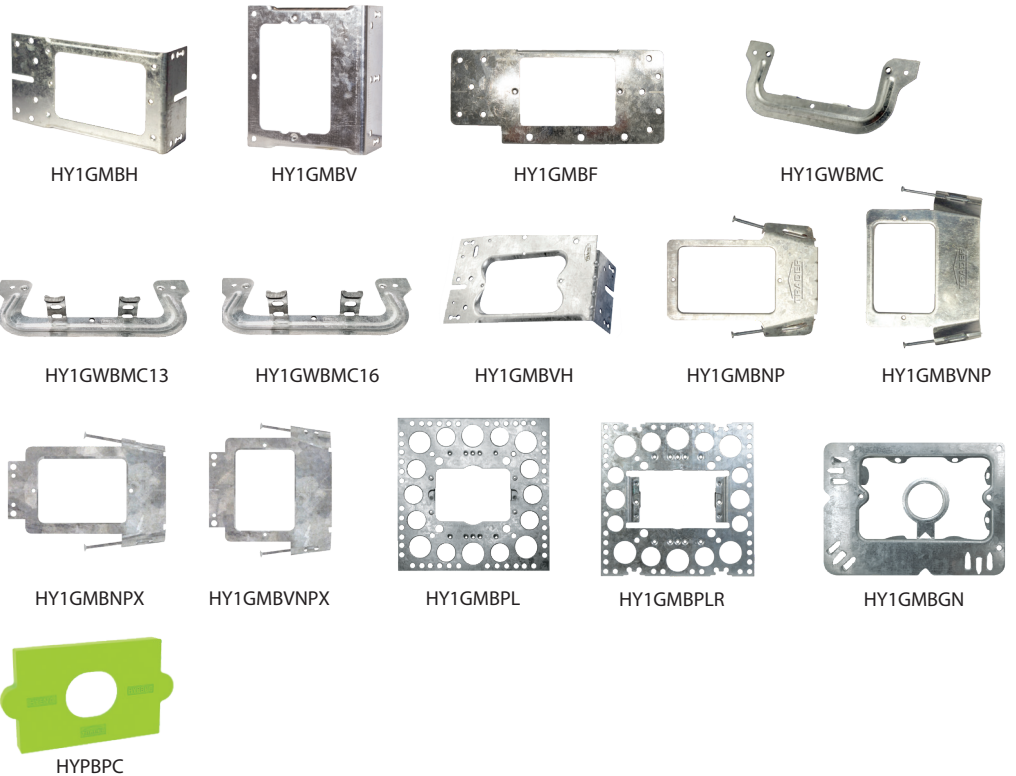

Catalogue Number	Description
HY1GMBH	Mounting Bracket 1 Gang, Horizontal
HY1GMBV	Mounting Bracket 1 Gang, Vertical
HY1GMBF	Mounting Bracket 1 Gang, Flat
HY1GWBMC	Mounting Clip, 1 Gang for 10mm wall panel
HY1GWBMC13	Mounting Clip, 1 Gang for 13mm wall panel
HY1GWBMC16	Mounting Clip, 1 Gang for 16mm wall panel
HY1GMBVH	Mounting Bracket, 1 Gang, Vertical / Horizontal
HY1GMBNP	Mounting Bracket 1 Gang, Horizontal
HY1GMBVNP	Mounting Bracket 1 Gang, Vertical Nail Plate
HY1GMBNPX	Mounting Bracket, 1 Gang, Nail Plate, Extra Large, Horizontal
HY1GMBVNPX	Mounting Bracket, 1 Gang, Nail Plate, Extra Large, Vertical
HY1GMBPL	Mounting Bracket, 1 Gang, Nail Plate, Extra Large, Vertical
HY1GMBPLR	Plaster Bracket, 1 Gang, Vertical or Horizontal, Mounting Recessed for Flat Cat
HY1GMBGN	Mounting Bracket with Gang Nail Fit Off
HYPBPC	Plaster Bracket Plastic Cover

GSM Electrical (Australia) Pty Ltd

Level 2, 142-144 Fullarton Road, Rose Park SA 5067

P: 1300 301 838 F: 1300 301 778 E: service@gsme.com.au

www.gsme.com.au



Mounting Brackets

PAGE 2 of 2

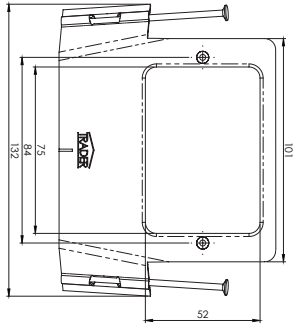

HY1GMBVNP

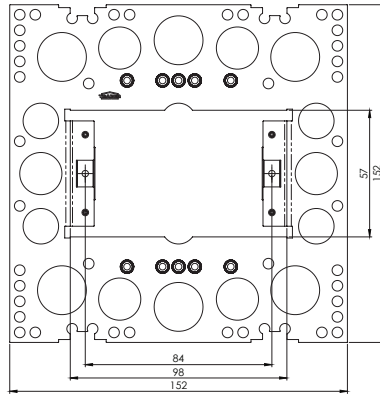

HY1GMBPLR

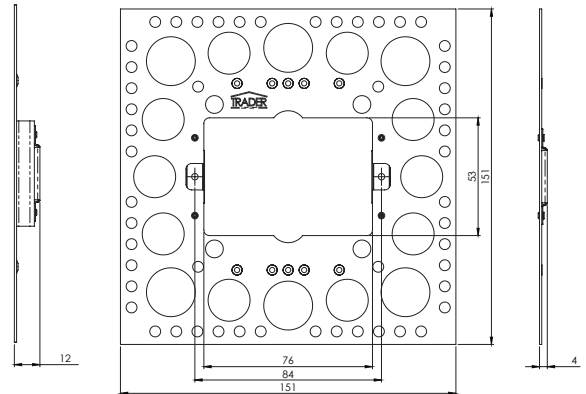

HY1GMBPL

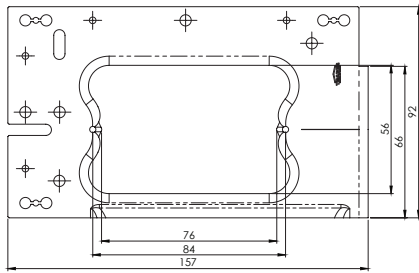

HY1GMBVH

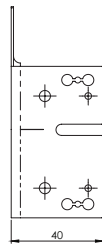

HY1GMBV

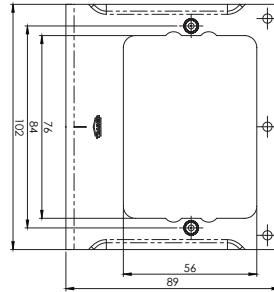

HY1GMBNP

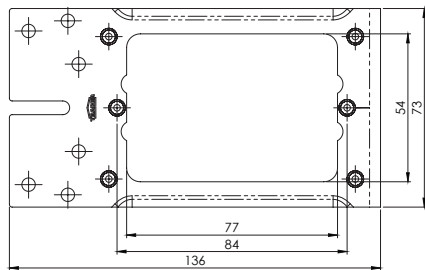
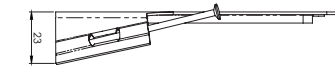
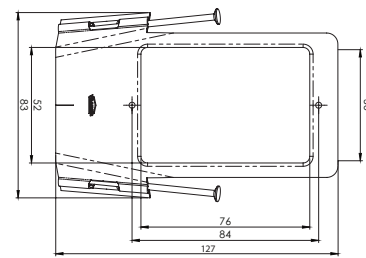

HY1GMBH

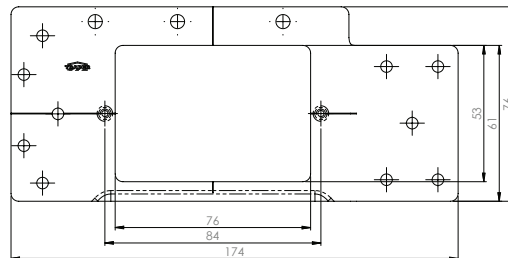
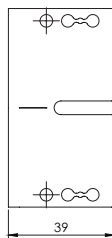

HY1GMBF

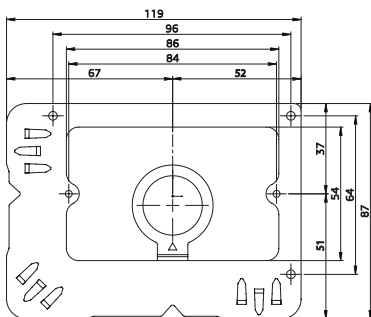

HY1GMBGN

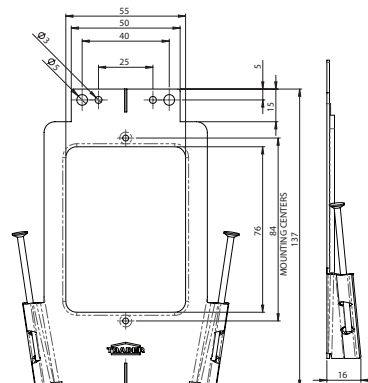

HY1GMBNPX

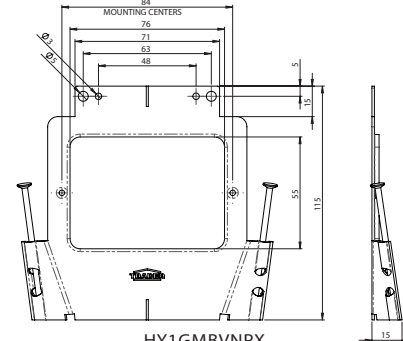

HY1GMBVNPX

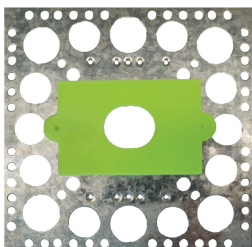

HYBPC with HY1GMBPL

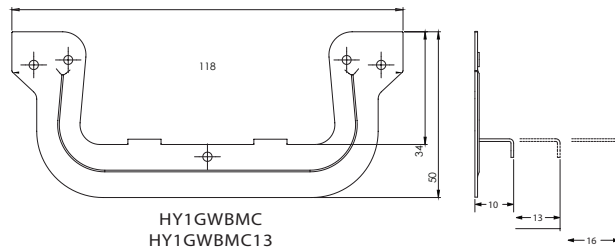

HY1GWBMC
HY1GWBMC13
HY1GWBMC16

