

**Data Sheet | Item Number: 221-682**

Splicing connector with levers; for all conductor types; for Ex e applications; max. 6 mm<sup>2</sup>; 2-conductor; transparent housing; Operating temperature (max.): 105 °C; 6,00 mm<sup>2</sup>; transparent



<https://www.wago.com/221-682>



Color:  transparent

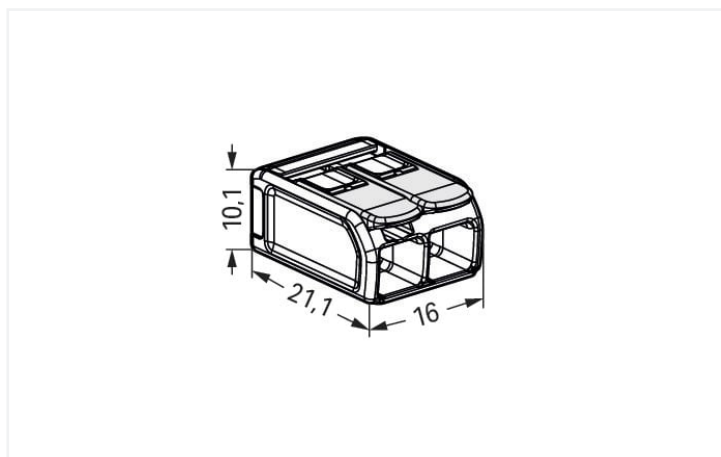
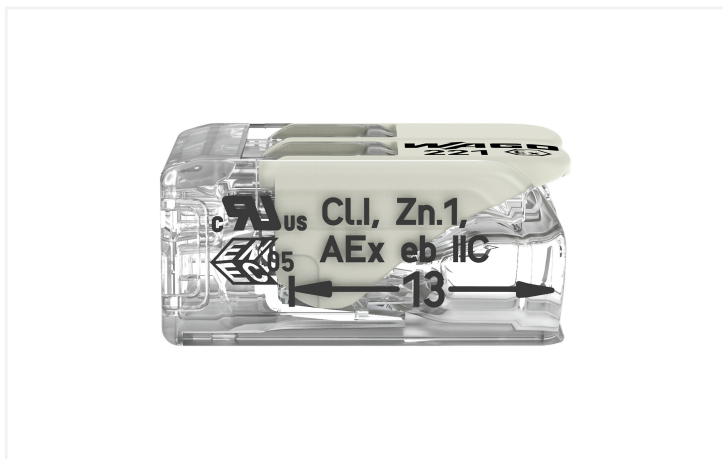

Dimensions in mm

Your benefits:

- Ease of use – pull the lever up, insert a conductor and push the lever back down
- Available as 2-, 3- and 5-wire connectors
- Easily terminate conductors from 0.5 to 6 mm<sup>2</sup>
- Connection of all conductor types
- Time savings for installers and device manufacturers
- Quickly install devices with higher power consumption
- Safely install long cable runs with larger conductor cross sections
- Mounting carrier for installation conforms to standards
- Working voltages of 275 V or 440 V
- Custom carriers are possible
- ATEX (Ex 2 II G), IECEx (Ex eb IIC Gb) Zone 1, 2
- IECEx (Ex eb IIC Gb), American Ex (AEx eb IICGb) / Class 1, Zone 1

**Notes**

Safety management note	<p><b>NOTICE: Observe installation and safety instructions!</b></p> <ul style="list-style-type: none"> <li>• <b>Only to be used by electricians!</b></li> <li>• Do not work under voltage/load!</li> <li>• Use only for proper use!</li> <li>• Observe national regulations/standards/guidelines!</li> <li>• Observe technical specifications for the products!</li> <li>• Observe the number of permissible potentials!</li> <li>• Do not use damaged/dirty components!</li> <li>• Observe conductor types, cross-sections and strip lengths!</li> <li>• Insert conductor until it hits the product's backstop!</li> <li>• Use original accessories!</li> </ul> <p><b>To be sold only with installation instructions!</b></p>
------------------------	--

Safety Information	The permissible operating voltage of the connector with carrier (440 V or 275 V) depends on the mounting type.
--------------------	--

Safety information 2	<p>Only approved in conjunction with a mounting carrier (221-511). Other carriers are possible, see certificate/file.</p> <p>The connectors must be installed in an enclosure meeting the requirements of a recognized protection type per EN 60079-0, Section 1 or EN 60079-31.</p> <p>When installing the connectors in an enclosure of protection type "eb" (increased safety) per EN 60079-7, the clearances and creepage distances of Table 2 for this standard must be observed. See point 1 for the use of accessories. The connectors can be used both in Group II and Group I, as the standard requirements are identical in this case. The use of these components requires a new assessment by a notified certification agency.</p>
----------------------	--

**Electrical data**

Approvals per	UL 60079			Ex information	
Use group	B	C	D	Ratings per	ATEX: PTB 19 ATEX 1001 U / IECEx: PTB 19.001 1U (Ex eb IIC Gb)
Rated voltage	-	440 V	-	Rated voltage EN (Ex e II)	440 V
Rated current	-	30 A	-	Rated current (Ex e II)	37 A

**Connection data**

Clamping units	2	<b>Connection 1</b>	
Total number of potentials	1	Connection technology	CAGE CLAMP®
		Actuation type	Lever
		Connectable conductor materials	Copper
		Nominal cross-section	6 mm <sup>2</sup> / 10 AWG
		Solid conductor	0.5 ... 6 mm <sup>2</sup> / 20 ... 10 AWG
		Stranded conductor	0.5 ... 6 mm <sup>2</sup> / 20 ... 10 AWG
		Fine-stranded conductor	0.5 ... 6 mm <sup>2</sup> / 20 ... 10 AWG
		Strip length	12 ... 14 mm / 0.47 ... 0.55 inches
		Wiring direction	Side-entry wiring

### Physical data

Width	16 mm / 0.63 inches
Height	10.1 mm / 0.398 inches
Depth	21.1 mm / 0.831 inches

### Material data

Note (material data)	<a href="#">Information on material specifications can be found here</a>
Color	transparent
Material group	IIIa
Insulation material (main housing)	Polycarbonate (PC)
Flammability class per UL94	V2
Fire load	0.066 MJ
Actuator color	light gray
Weight	3 g

### Environmental requirements

Ambient temperature (storage)	-40 ... +60 °C
Continuous operating temperature	-55 ... +105 °C

### Commercial data

ETIM 9.0	EC000446
ETIM 8.0	EC000446
PU (SPU)	500 (50) pcs
Packaging type	Box
Country of origin	CH
GTIN	4055143860390
Customs tariff number	85369010000

### Environmental Product Compliance

RoHS Compliance Status	Compliant, No Exemption
------------------------	-------------------------

### Approvals / Certificates

#### General approvals



Approval	Standard	Certificate Name
CB DEKRA Certification B.V.	IEC 60998	NL-81003
cULus_Listed_667F Underwriters Laboratories Inc.	UL 486C	E69654
ENEC 05 DEKRA Certification B.V.	EN 60998	71-123784

#### Declarations of conformity and manufacturer's declarations

Approval	Standard	Certificate Name
ATEX-Attestation of Con- formity WAGO GmbH & Co. KG	-	-
EU-Declaration of Confor- mity WAGO GmbH & Co. KG	-	-
UK-Declaration of Confor- mity WAGO GmbH & Co. KG	-	-

Approvals for marine applications

Approvals for hazardous areas



Approval	Standard	Certificate Name
LR Lloyds Register	EN 60998	LR22207029TA



Approval	Standard	Certificate Name
AEx Underwriters Laboratories Inc.	UL 60079	E185892 (AEx eb IIC resp. Ex eb IIC)
ATEX Physikalisch Technische Bundesanstalt	EN IEC 60079-0	PTB 19 ATEX 1001 U (II 2 G Ex eb IIC Gb, I M 2 Ex eb I Mb)
CCC CNEX	GB/T 3836.3	2020312313000185 (Ex eb IIC Gb, Ex eb I Mb)
IECEX Physikalisch Technische Bundesanstalt	IEC 60079-0	IECEX PTB 19.001 1U (EX eb IIC Gb, Ex eb I Mb)
INMETRO TÜV Rheinland do Brasil Ltda.	IEC 60079	TÜV 19.1781 U

Downloads

Environmental Product Compliance

Compliance Search
Environmental Product Compliance 221-682

Documentation

Bid Text
ausschreiben.de 221-682

CAD/CAE-Data

CAD data
2D/3D Models 221-682

CAE data
EPLAN Data Portal 221-682
ZUKEN Portal 221-682

1 Compatible Products

1.1 Optional Accessories

1.1.1 Mounting adapter

1.1.1.1 Mounting accessories



**Item No.: 221-510/000-006**

Mounting carrier; 221 Series - 6 mm<sup>2</sup>; for DIN-35 rail mounting/screw mounting; blue

**Item No.: 221-511**

Mounting carrier; for Ex applications; 221 Series - 6 mm<sup>2</sup>; for DIN-35 rail mounting/screw mounting; light gray

Installation Notes

Conductor termination

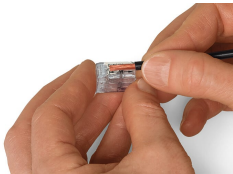

Strip conductor to 11 mm (0.43 inch).

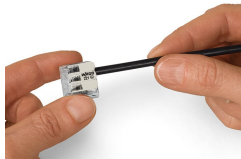

Then, lower the lever to close the clamp.

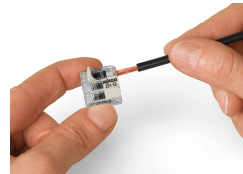

Termination: Lift the lever to open the clamping unit and insert a stripped conductor.

Installation

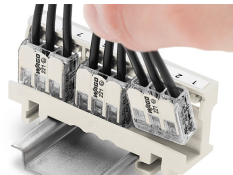

Inserting a connector into the mounting carrier.

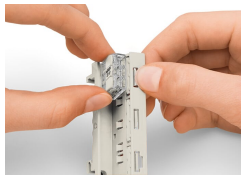

Removing a connector from the mounting carrier.

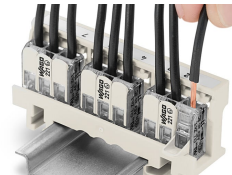

Removing a conductor.

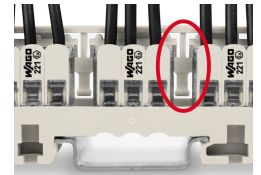

**Mounting type (440 V)**  
Using spacers between the connectors.



**Mounting type (440 V)**  
Vertical mounting on DIN-35 rail

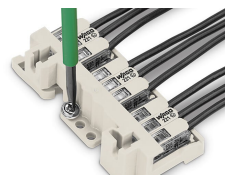

**Mounting type (440 V)**  
Horizontal screw mounting on a flat surface



**Mounting type (440 V)**  
Mounting the carrier via non-conductive screws.

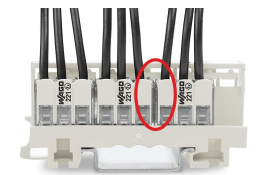

**Mounting type (275 V)**  
No spacers are used between the connectors.

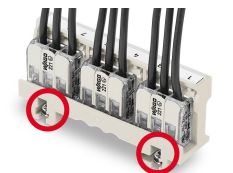

**Mounting type (275 V)**  
Mounting the carrier using conductive screws.

## Testing

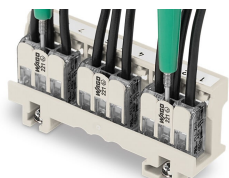

Easily test inserted connectors in the carrier – however they are mounted.