

Data Sheet | Item Number: 221-683

Splicing connector with levers; for all conductor types; for Ex e applications; max. 6 mm²; 3-conductor; transparent housing; Operating temperature (max.): 105 °C; 6,00 mm²; transparent



<https://www.wago.com/221-683>



Color: transparent



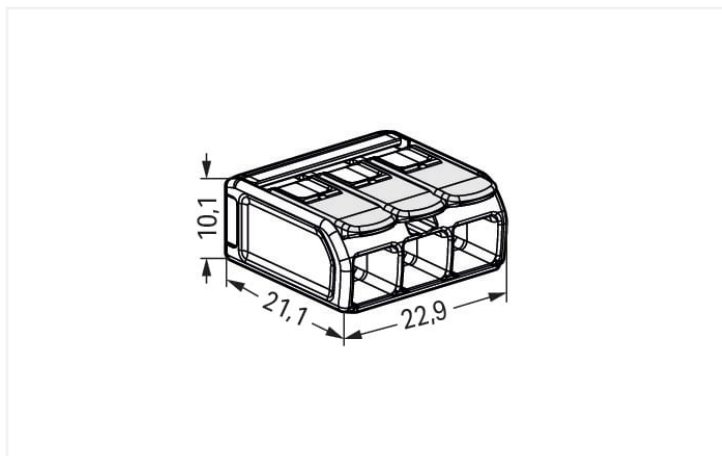

Dimensions in mm

Your benefits:

- Ease of use – pull the lever up, insert a conductor and push the lever back down
- Available as 2-, 3- and 5-wire connectors
- Easily terminate conductors from 0.5 to 6 mm²
- Connection of all conductor types
- Time savings for installers and device manufacturers
- Quickly install devices with higher power consumption
- Safely install long cable runs with larger conductor cross sections
- Mounting carrier for installation conforms to standards
- Working voltages of 275 V or 440 V
- Custom carriers are possible
- ATEX (Ex 2 II G), IECEx (Ex eb IIC Gb) Zone 1, 2
- IECEX (Ex eb IIC Gb), American Ex (AEx eb IICGb) / Class 1, Zone 1

Notes	
Safety management note	<p>NOTICE: Observe installation and safety instructions!</p> <ul style="list-style-type: none"> • Only to be used by electricians! • Do not work under voltage/load! • Use only for proper use! • Observe national regulations/standards/guidelines! • Observe technical specifications for the products! • Observe the number of permissible potentials! • Do not use damaged/dirty components! • Observe conductor types, cross-sections and strip lengths! • Insert conductor until it hits the product's backstop! • Use original accessories! <p>To be sold only with installation instructions!</p>
Safety Information	<p>The permissible operating voltage of the connector with carrier (440 V or 275 V) depends on the mounting type.</p>
Safety information 2	<p>Only approved in conjunction with a mounting carrier (221-511). Other carriers are possible, see certificate/file.</p> <p>The connectors must be installed in an enclosure meeting the requirements of a recognized protection type per EN 60079-0, Section 1 or EN 60079-31.</p> <p>When installing the connectors in an enclosure of protection type "eb" (increased safety) per EN 60079-7, the clearances and creepage distances of Table 2 for this standard must be observed. See point 1 for the use of accessories. The connectors can be used both in Group II and Group I, as the standard requirements are identical in this case.</p> <p>The use of these components requires a new assessment by a notified certification agency.</p>

Electrical data

Approvals per	UL 60079		
Use group	B	C	D
Rated voltage	-	440 V	-
Rated current	-	30 A	-

Ex information

Ratings per	ATEX: PTB 19 ATEX 1001 U / IECEx: PTB 19.001 1U (Ex eb IIC Gb)
Rated voltage EN (Ex e II)	440 V
Rated current (Ex e II)	37 A

Connection data

Clamping units	3
Total number of potentials	1

Connection 1

Connection technology	CAGE CLAMP®
Actuation type	Lever
Connectable conductor materials	Copper
Nominal cross-section	6 mm ² / 10 AWG
Solid conductor	0.5 ... 6 mm ² / 20 ... 10 AWG
Stranded conductor	0.5 ... 6 mm ² / 20 ... 10 AWG
Fine-stranded conductor	0.5 ... 6 mm ² / 20 ... 10 AWG
Strip length	12 ... 14 mm / 0.47 ... 0.55 inches
Wiring direction	Side-entry wiring

Physical data

Width	22.9 mm / 0.902 inches
Height	10.1 mm / 0.398 inches
Depth	21.1 mm / 0.831 inches

Material data

Note (material data)	Information on material specifications can be found here
Color	transparent
Material group	Illa
Insulation material (main housing)	Polycarbonate (PC)
Flammability class per UL94	V2
Fire load	0.097 MJ
Actuator color	light gray
Weight	4.3 g

Environmental requirements

Ambient temperature (storage)	-40 ... +60 °C
Continuous operating temperature	-55 ... +105 °C

Commercial data

ETIM 9.0	EC000446
ETIM 8.0	EC000446
PU (SPU)	300 (30) pcs
Packaging type	Box
Country of origin	CH
GTIN	4055143860574
Customs tariff number	85369010000

Environmental Product Compliance

RoHS Compliance Status Compliant, No Exemption

Approvals / Certificates

General approvals			Declarations of conformity and manufacturer's declarations		
Approval	Standard	Certificate Name	Approval	Standard	Certificate Name
CB DEKRA Certification B.V.	IEC 60998	NL-81003	ATEX-Attestation of Conformity WAGO GmbH & Co. KG	-	-
cULus_Listed_667F Underwriters Laboratories Inc.	UL 486C	E69654	EU-Declaration of Conformity WAGO GmbH & Co. KG	-	-
ENEC 05 DEKRA Certification B.V.	EN 60998	71-123784	UK-Declaration of Conformity WAGO GmbH & Co. KG	-	-

Approvals for marine applications **Approvals for hazardous areas**

Approvals for marine applications			Approvals for hazardous areas		
Approval	Standard	Certificate Name	Approval	Standard	Certificate Name
LR Lloyds Register	EN 60998	LR22207029TA	AEx Underwriters Laboratories Inc.	UL 60079	E185892 (AEx eb IIC resp. Ex eb IIC)
			ATEX Physikalisch Technische Bundesanstalt	EN IEC 60079-0	PTB 19 ATEX 1001 U (II 2 G Ex eb IIC Gb, I M 2 Ex eb I Mb)
			CCC CNEX	GB/T 3836.3	2020312313000185 (Ex eb IIC Gb, Ex eb I Mb)
			IECEx Physikalisch Technische Bundesanstalt	IEC 60079-0	IECEx PTB 19.001 1U (EX eb IIC Gb, Ex eb I Mb)
			INMETRO TÜV Rheinland do Brasil Ltda.	IEC 60079	TÜV 19.1781 U

Downloads

Environmental Product Compliance

Compliance Search	
Environmental Product Compliance 221-683	↓

Documentation

Bid Text

ausschreiben.de
221-683



CAD/CAE-Data

CAD data

2D/3D Models 221-683



CAE data

EPLAN Data Portal
221-683



ZUKEN Portal 221-683



1 Compatible Products

1.1 Optional Accessories

1.1.1 Mounting adapter

1.1.1.1 Mounting accessories



Item No.: 221-510/000-006

Mounting carrier; 221 Series - 6 mm²; for DIN-35 rail mounting/screw mounting; blue

Item No.: 221-511

Mounting carrier; for Ex applications; 221 Series - 6 mm²; for DIN-35 rail mounting/screw mounting; light gray

Installation Notes

Conductor termination

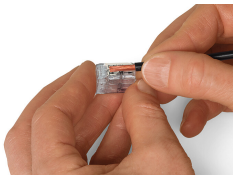

Strip conductor to 11 mm (0.43 inch).

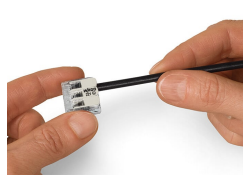

Then, lower the lever to close the clamp.

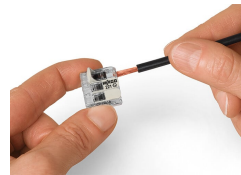

Termination: Lift the lever to open the clamping unit and insert a stripped conductor.

Installation

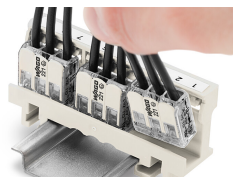

Inserting a connector into the mounting carrier.

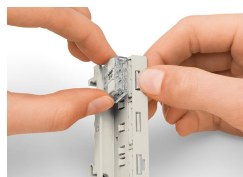

Removing a connector from the mounting carrier.

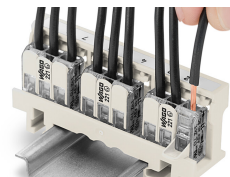

Removing a conductor.

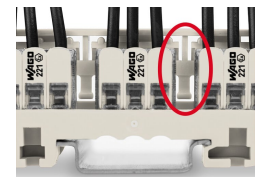

Mounting type (440 V)
Using spacers between the connectors.

Installation



Mounting type (440 V)

Vertical mounting on DIN-35 rail

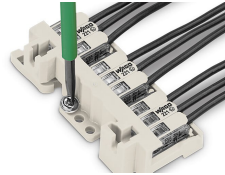

Mounting type (440 V)

Horizontal screw mounting on a flat surface

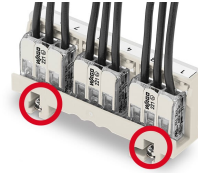

Mounting type (440 V)

Mounting the carrier via non-conductive screws.

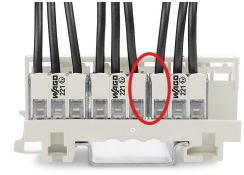

Mounting type (275 V)

No spacers are used between the connectors.

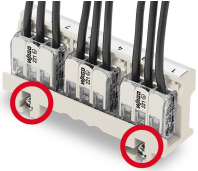

Mounting type (275 V)

Mounting the carrier using conductive screws.

Testing

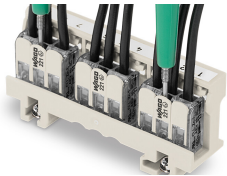

Easily test inserted connectors in the carrier – however they are mounted.